



————— 2023 —————

**BUSINESS PRODUCTS**  
**WORKPLACE SOLUTIONS**

Technology • Jan/San • Breakroom • Health and Safety • Furniture • Office Products

# The best *shipping* starts with

**Scotch**  
Brand



## Sticks instantly to any box.

Scotch® Box Lock™ Shipping Tape



## The smart way to ship.

Scotch® Cushion Lock™ Protective Wrap



Scotch® Box Lock™ Shipping Tape ensures boxes stay securely sealed during rough handling. This tape can be used to seal any type of box, including 100% recycled boxes.

- ▶ Extreme sticking power
- ▶ Designed for better box adhesion
- ▶ Guaranteed to stay sealed\*
- ▶ Recommended application temperature range 40°F to 120°F

Scotch® Cushion Lock™ Protective Wrap is an expanding paper wrap that replaces the need for traditional plastic cushion and void fill. It acts as a cushion and filler in one.

- ▶ Expands up to 60x its original volume, filling the box with less material and eliminating the need for other void fill.
- ▶ Made with 100% recycled paper
- ▶ Curbside recyclable upon disposal where facilities exist
- ▶ Uniquely designed pattern interlocks upon itself, eliminating the need for tape

\*If your box does not stay sealed, 3M will refund the purchase price of this tape. Proof of purchase required.

# Introducing the 2023-2024 Catalogue

**While no one can predict the future,  
there is one thing we can count on... change!**

For most of us the pandemic brought changes to how we lived, played, stayed healthy, and worked. Overnight our needs and priorities shifted. Notably, one of the most dramatic shifts was in the workplace. Remote working emerged as the leading trend, made possible by today's advanced technology.

While banana bread and a more relaxed dress code may have made working from home more comforting initially, it was collaboration tools such as video conferencing and cyber security measures, that allowed us to stay connected and productive. We proved ourselves to be resilient, quickly adapting to the evolving landscape. Buzzwords such as WFH, pivot, unmute, and "is your audio on" became standard.

As the workplace continues to evolve so does our offering! We understand we all have very distinct needs and recognize there is no one-size-fits-all! This catalogue is the perfect example of that!

While this catalogue covers all the basics, we have put a continued emphasis on growing trends such as technology, hybrid work, education, health and safety, arts and crafts, and breakroom supplies.

And there's more! We are always sourcing new products, so be sure to check out our comprehensive online catalogue for the latest.

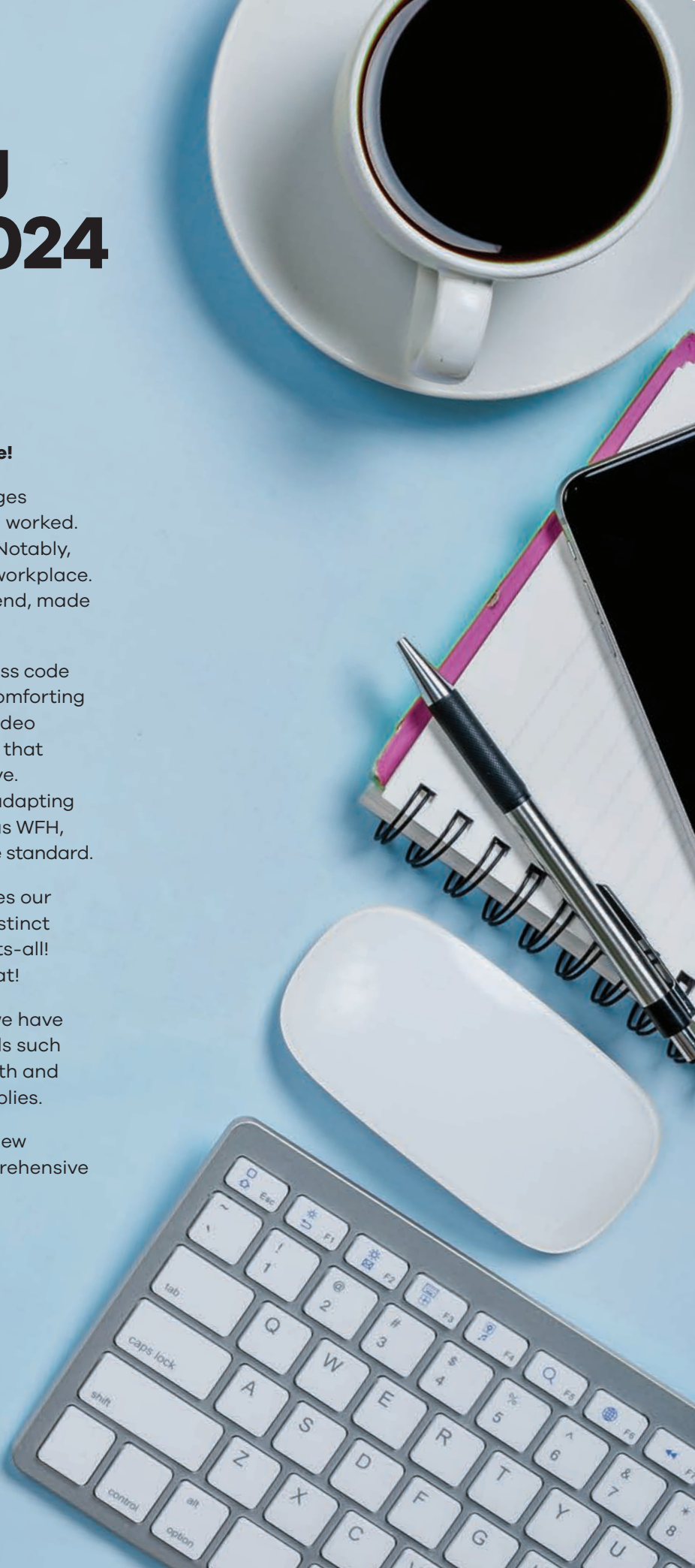

# Work-Life Balance

## WHAT IS A HEALTHY WORK-LIFE BALANCE?

A healthy work-life balance means you have harmony between the different aspects of your life. The benefits gained from each area can support and strengthen the others. It's not so much about splitting your time 50/50 between work and play but finding the balance that works best for you.

## WHY DO YOU NEED WORK-LIFE BALANCE?

Work is generally good for our health and well-being. It provides routine, promotes relationships and a sense of community, and offers a sense of meaning and purpose. A small amount of stress, such as working to a deadline, can be helpful and lead to increased alertness and productivity. However, consistently working long hours without balancing it (even if you love what you do) with good health habits, such as proper rest and relaxation, can have a negative toll on your health.

## WHAT HAPPENS WHEN YOU CREATE BALANCE?

- With healthy habits your overall health and wellness will improve.
- You will have more time to nurture relationships with friends and family.
- Your quality of work will improve, and productivity will increase.
- You will be more enthusiastic and engaged at work, enjoying it more.
- You will have more time to pursue new interests.
- With better focus you will be able to think more creatively.
- You can be more mindful and attuned to your feelings and those of others.
- You will think more positively and be more aware of the good around you.
- Prioritizing and focusing on what is important to you enables you to create more success on your terms.

In a recent Canadian survey done by Leger, a Canadian-owned market research and analytics firm, almost 31% of respondents say they enjoy the improvements in their flexible work schedules and 26% say they enjoy an easy work-life balance. Interestingly, respondents who reported they have been more productive since the start of the pandemic, were more likely to have a water bottle on their desks at work (73%), participate in work-related activities (38%) and enjoy decorating their workspace with plants (34%). They also report a higher level of engagement to their work and to their employer.



# Easy Ways to Add Balance to Your Workday



## CREATE AN INTENTIONAL WORKSPACE

### Prioritize an ergonomic set-up

Working in a space designed with ergonomics in mind can help lower bodily stress, make you more comfortable, improve productivity, and make you feel better!

### Set the mood

Just like taking a walk on a nice sunny day, we know how natural lighting affects our mood and productivity. Lamps that offer different light modes will help reduce fatigue and eyestrain. Plants are natural mood lifters that add a visually meditative effect, leading us to being more productive and happier!

## BUILD POSITIVE WORKPLACE RELATIONSHIPS

Supportive relationships have a positive effect on our well-being and impacts our personal happiness. They help keep us motivated, share in successes, and opportunities while boosting morale.

## PRACTICE TIME MANAGEMENT

From setting goals to organizing your tasks tools such as apps and calendars can be helpful. Determine your priorities. If you have a long to-do list aim to complete 6 instead of 12 tasks, then you will be more motivated to achieve them. At the end of each day, set your priorities for the following day.

### Try the 2-minute rule

The 2-minute rule suggests if you think a task can be done in 2 minutes or less, do it. If you are a procrastinator, the 2-minute rule is a helpful strategy that keeps small tasks from being added to your to-do list like a load of laundry that you put off doing. Using this strategy, you will find that almost every habit can be downsized into a two-minute version. For example, "Create a work presentation" becomes "Choosing fonts and titles". This will make bigger tasks more manageable and less challenging, leading you down a more productive path.

## BE GOOD TO YOURSELF

### Embrace vacations & breaks

Dedicated time off for the purpose of R&R is essential for our health and well-being. Breaks allow us to boost our energy reserves and when we feel rejuvenated and recharged, we are more productive.

### The 20/20/20 rule

Computer eye strain can lead to dry eyes, blurry vision, and headaches. A good idea is to follow the 20/20/20 rule: every 20 minutes, look at something 20 feet away for 20 seconds.

### Practice healthy habits

Maintain a regular sleep schedule. Choose healthy snacks like fruit and nuts. Keep a water bottle at your desk and move around every 30 minutes.

### Breathe

Take a deep breath. It is a good way to relax and relieve stress.

# The Hybrid Office

## What is the hybrid workplace model?

It is a flexible workplace model designed to support both in-office and remote employees. While there is no one-size-fits-all approach, advances in technology have made working and collaborating seamlessly from anywhere possible, making this work model viable for both the company and the employees.

## Why are companies shifting to hybrid work?

Emerging from the pandemic, both employees and employers are now looking toward the future. Employees are more likely to prioritize wellness and work flexibility. Supporting the hybrid work model appeals to prospective employees and helps companies retain current employees.

## POPULAR HYBRID WORK MODELS

### Office Flexible (Balanced) Model

The flexible and balanced hybrid work approach is the current leading model. Employees choose their location and hours based on their priorities for the day. For example, they may go to the office for team building, collaborating on a project, or training. If they need to focus on a project that requires concentration, they may choose to work from home or the office.

### Office First ( Remote-friendly) Model

Employees are expected to work from the office but with some flexibility to choose to work remotely. With this model employees are usually given a couple days per week or a week per month for remote work.

### Remote First Model

In this model working remotely is the default. It may be that the company doesn't have an office space, or the employee may live outside of the geographic area where the organization is located.

## RETHINKING THE TRADITIONAL OFFICE SPACE

The hybrid workplace serves as a social anchor, a space where employee interaction is encouraged through smart design and layout. It calls for a variety of work settings to serve a multitude of purposes including team bonding, collaboration, training, social networking, break areas, and customer experiences.





## DESIGN & LAYOUT TRENDS

- Open collaborative spaces for high-energy work teams
- Team huddle areas for sharing ideas
- Areas for whiteboarding sessions
- Private meeting areas
- Quiet-zones or booths for focused work
- Town hall areas equipped with video conferencing cameras and screens
- Training & mentoring rooms
- Breakrooms that provide a positive look and feel
- Community lounge and rest areas
- Wi-fi enabled spaces for remote users and guests
- Indoor/outdoor green rest areas

## ERGONOMICS & FURNITURE CONSIDERATIONS:

- Ergonomic seating
- Sit-stand desking
- Mobile workstations
- Modular seating
- Café seating & tables for indoor/outdoor spaces
- Casual breakroom and lounge seating
- Larger tables for planning sessions and collaborative work
- Smaller more intimate tables that accommodate 5-6 people
- Digital and mobile boards and easels
- Mobile storage
- Lighting
- Break stations complete with espresso machines, etc.

## COLLABORATION AND COMMUNICATION TOOLS FOR CONSIDERATION:

- Noise-cancelling headsets and headphones
- Laptops and monitors
- Webcams
- Conference cameras
- Microphones
- Speakers
- Conference telephones

# 5 Tips for Making the Hybrid Workplace a Success!

## FOCUS ON HEALTH AND WELLNESS

Most companies prioritize workplace safety, ergonomics, and physical well-being, but social connections are important for our emotional well-being. When you see your teammates daily, you naturally build a connection. Encourage both office and remote employees to have regular face-to-face chats in person, or on video, to connect and build supportive working relationships.

## COMMUNICATE

In the office, there are opportunities to learn important information, hear the latest news. You may pass the bulletin board in the lunch area or hear the “buzz” in the office. Ensure that remote employees are provided the same opportunities for success as those in office. Share job postings, news, and company updates with everyone at the same time so no one feels like they are out of the loop, and everyone feels like an equal. Be sure all team members are properly trained on new tools and apps, offering them support when needed. This will help keep your team happily engaged and doesn't create unfair advantages.

## INVEST IN TECHNOLOGY

Invest in technology that enables seamless communication between your remote and in-office teams. Employees need to be able to communicate, collaborate and share ideas as they would in the office. Video conferencing, cloud-based workflow software, and tools such as noise-cancelling headsets, laptops, and monitors are essential to maintaining productivity.

## CULTURE

A successful hybrid approach starts with clear and transparent messaging that supports the company culture. Being visible and supportive through virtual social events and town hall meetings encourages team bonding, motivation, and keeps everyone connected to the company's values and goals.

## ENCOURAGE FEEDBACK

To maintain productivity and fairness, regularly encourage feedback sessions, either through an open-door policy, or other methods such as a survey tool. This is an opportunity to discuss what's working and what isn't in real time, and then make policy improvements. This sense of empowerment leads to greater employee engagement and productivity.





# 9 Best Practices The Hybrid Meeting

**It is no longer enough to have a speaker phone in the middle of the table, with the remote employees dialing in. In-office and remote office employees need an interactive environment to collaborate and share ideas effectively. Virtual meetings offer better engagement, collaboration, and team bonding, making us happier and more productive.**

## USE TECHNOLOGY AND TECH TOOLS

Seeing each other's expressions connects us and improves communication. Encourage video conferencing. Use a meeting room that can accommodate a large screen so in-office and remote employees can easily interact as if they are in the same room. Alternatively, request that all the participants log in to the meeting separately from their desks. This eliminates side-conversations, allowing everyone to engage equally. Upgrade tech tools to include good microphones, speakers, noise-cancelling headphones, and webcams.

## SEND THE INVITE

Include the details or meeting purpose in an email or calendar invite, along with call-in numbers, instructions, and meeting links. Set expectations ahead of the meeting by adding "cameras on" or "camera optional".

## SHARE AN ADVANCE AGENDA

Successful meetings require preparation. Sharing the agenda and setting context in advance gives everyone a chance to get ready to contribute.

## START AND END TIMES

Start the meetings on time even if all your participants haven't arrived. You want to respect everyone's schedules and attention spans.



## SHOW UP EARLY

Never be late for a virtual meeting. Make it a habit of logging on to your call 5 minutes before the meeting begins, to adjust your camera, microphone, or sort out any technical difficulties.

## READY, SET, START

Encourage everyone to go on mute when they're not speaking. Give them guidelines - when they should ask questions, or if they can jump in anytime. If it is an option, utilize text-based chat to keep remote employees engaged, inviting peer-to-peer comments, learning and sharing.

## ICEBREAKER STARTER

An icebreaker encourages us to relax and forget about everything else for a few minutes. Great for team bonding it gets us talking, can generate laughter, and makes us more comfortable with each other.

## LOOK INTO THE CAMERA

Look into the camera when you are speaking. Everyone on the call should receive equal attention. The goal is to make everyone feel included and less like observers.

## THINK REMOTE-FIRST

When you are gathered in a conference room, it is easy to lose yourself in a conversation and forget about your remote colleagues. Ensure everyone is as involved as possible, creating an equal playing field between remote and in-office employees.



# 10 Best Practices Business Email Etiquette



## **MAKE YOUR SUBJECT LINE COUNT**

Take the time to write a clear concise subject line relevant to the content of your email. This helps determine the priority of the email. Subject lines such as "Touching base" or "FYI", just make the task time-consuming for the reader. It also makes locating archived emails more challenging.

## **INCLUDE A SIGNATURE**

Include all your contact details, including your full name, contact numbers and email address so the recipient doesn't have to go searching for it. Choose simple fonts in a 11- or 12-point size.

## **GREETINGS**

Use professional greetings such as "Good Morning" or "Hello." "Greetings such as "Hey" or "What's up" communicates a lack of professionalism. To be more formal, you can use "Dear (insert name)".

## **AVOID HUMOUR**

Without tone or facial expressions, humour can be misinterpreted or even offend without proper context. Humour is usually culture specific, so never include it, especially in a professional setting. Refrain from using emojis unless you have had casual email conversations where they have been used.

## **PROOFREAD BEFORE SENDING**

Make sure that you check your grammar and spelling before hitting the send button. Not doing so may make you seem unprofessional.

## **INCLUDE THREADS**

When referencing previous emails always include conversation threads and attachments for context.

## **DOUBLE-CHECK ATTACHMENTS**

It is a good idea to let the recipient know you are attaching a file. If the document is large, zip it up, or include a link to a secure cloud storage file, where the recipient can safely access it.

## **REPLY TO EMAILS**

It may be hard to answer every email you receive, but it is important to make the effort to try. If the email is a question and you don't have the answer, acknowledge the email, and let the sender know you will get back to them. The expected follow-up time to respond to an email is typically 24-48 hours.

## **RESIST THE REPLY ALL BUTTON**

Avoid using "Reply-to-All" unless everyone on the list really needs to know. Not doing so can lead to inundating people with unnecessary emails and distracting email alerts.

## **KEEP IT PRIVATE**

Write like nothing is confidential. Email is public. Even though an email is deleted, online services and software programs can access messages on the hard drive. Before you click "send" consider what would happen if the email got into the wrong hands.



# 10 Best Practices Professional Texting

## QUALITY OVER QUANTITY

Staying in touch is important but don't overdo it. Strive for quality over quantity and be careful not to communicate the same message by email, text, and phone. Choose one method and wait for a response.

## CRAFT YOUR MESSAGE

With a standard text message, you only have 160 characters to make your point. Be thoughtful, stick to quick, actionable messages.

## IDENTIFY YOURSELF

Avoid confusion, always clearly identify yourself when you are starting a text conversation.

## GO EASY ON THE ACRONYMS

Don't alienate your readers by using last week's acronyms that may be unfamiliar to them. Stick to the more mainstream ones such as EOD, LMK, and BTW.



## MINIMIZE USING EMOJIS

Don't overdo it and avoid using them in serious conversations.

## PROOFREAD CAREFULLY

Research has shown that our brain often works too efficiently. It helps us understand what we are reading but doesn't necessarily find our errors. For example, if you have been working on a document or a text for a while, your brain will often skim over misspelled or missing words. Don't rely on voice-to-text or auto-correct, they are prone to errors.

## KEEP IT PRIVATE

Refrain from texting confidential information. Protect yourself and your customers by keeping personal data off texts.

## SEND DURING BUSINESS HOURS

Respect your customer's privacy by sending and responding to texts during working hours.

## RESPOND PROMPTLY

Every time you send a text you are making a deliberate connection, giving the customer an opportunity to respond and give you valuable feedback. Make sure you reply (even if it is an automated message) to keep them engaged.

## GET PERMISSION. IMPORTANT!

Canada's Anti-Spam Legislation requires you to get consent before sending commercial electronic messages to Canadian recipients.



# Table of Contents

## 012 TECHNOLOGY AND OFFICE MACHINES

- Video Conferencing
- Headsets and Communication
- Mobile Accessories
- Data Storage and Media
- Computer Accessories
- Cables and Power Management
- Printers and Scanners
- Office Machines

498

## 156 WORKPLACE FURNITURE

- Workstations
- Office and Conference Room Seating
- Reception and Lounge Furniture
- Cafeteria and Lunchroom Furniture
- Filing and Storage

406

218

### Icons that can help you identify product features at a glance



New for 2023



Environment handling fees (EHF)



Products with recycled content or green certification.



Assembly required



Made in Canada



Manufacturer's Express program. 2-4 weeks.



Good value products



Products with flammable content

#### CONNECTIVITY



USB



Bluetooth



Ethernet



WiFi



Aux 3.5

#### POWER SOURCE



Batteries



Electrical



Solar

#### PACKAGING



Quantity per box



Where you see this icon, please call Customer Service for your price.

## 218 WORKPLACE TOOLS AND ACCESSORIES

- Hybrid Work and Travel Accessories
- Desk and Workstation Accessories
- Boards and Easels
- Retail, Business and Event Supplies

## 288 BREAKROOM AND FACILITIES MANAGEMENT

- Breakroom
- Health and Safety
- Janitorial Maintenance and Supplies
- Mailroom and Handling

## 406 PAPER AND FILING

- Paper
- Notebooks and Pads
- Accounting and Business Forms
- Filing and Labelling Supplies

## 498 WORKPLACE ESSENTIALS

- Binders and Accessories
- Small Office Tools
- Office Supplies
- Stamps

## 586 WRITING AND CREATIVITY

- Writing and Correction
- Arts and Crafts
- Leisure and Games

NEW

## 658 EDUCATION

- School Supplies
- Early Learning
- Classroom Furniture

### BRIEFCASES

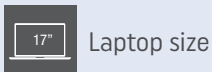
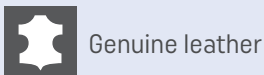

### SAFES

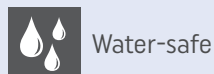

### SECURITY

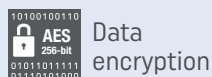

### SHREDDERS

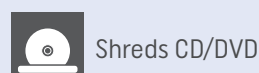
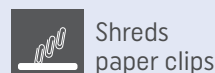
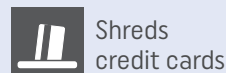

### PAPER, PUNCHES, STAPLERS, TRIMMERS, LAMINATION



**Check us out online.**

Our selection is updated regularly with new products.



# Ingenuity

Workers want the latest tools to create and maintain an efficient workspace. In this section you will find everything to equip your workspace at home, at the office, and everywhere in between.

# TECHNOLOGY AND OFFICE MACHINES

## VIDEO CONFERENCING

Conference Cameras and Speakers .....	14
Monitors and Projectors .....	19
Webcams .....	20
Privacy Filters .....	21
Software .....	23

## HEADSETS AND COMMUNICATION

Wireless Headsets .....	25
Wired Headsets .....	28
2-Way Radios .....	31

## MOBILE ACCESSORIES

MagSafe Compatible Accessories.....	32
Cases and Screen Protectors .....	33
Bluetooth Trackers .....	34
Chargers and Cables .....	35
Laptop Locks .....	38

## DATA STORAGE AND MEDIA

Internal Storage .....	41
Portable/External Storage .....	42
USB Keys .....	43
SD Memory Cards and Accessories .....	45
CD/DVD and Cartridges .....	46

## COMPUTER ACCESSORIES

Keyboards, Mice and Accessories .....	49
Document Holders .....	61
Stands and Risers .....	64
Cushions and Footrests .....	70
Cleaning Supplies .....	72

## CABLES AND POWER MANAGEMENT

Video Cables and Adapters .....	73
USB Cables and Hubs .....	75
Network Cables and Adapters .....	77
Omada Pro Switches, Routers and Accessories .....	78
WiFi, Bluetooth Router Kits, Adapters and Extenders .....	86
Docking Stations and Laptop Chargers .....	93
Battery Backups and UPS .....	95
Batteries .....	96
Surge Protectors and Extension Cords .....	100

## PRINTERS AND SCANNERS

Printers .....	103
Scanners .....	103
Ink and Toner .....	110

## OFFICE MACHINES

Shredders and Accessories .....	115
Label Makers and Tapes .....	122
Calculators .....	132
Binding Machines and Accessories .....	140
Laminating Machines and Accessories .....	145
Voice Recorders and Transcribers .....	150
Cash Handling Machines and Supplies .....	151
Time Clocks and Accessories .....	155

## JABRA PANACAST SERIES

# Video conferencing. Reinvented.

From the office, to the home office, and everywhere in between — remote meetings just as immersive and engaging as your in-person ones.



**PANACAST 20  
FOR PERSONAL USE**



**PANACAST MEET ANYWHERE  
FOR FLEXIBLE GROUP USE**



**PANACAST 50  
FOR MEETING ROOMS**

	PANACAST 20 FOR PERSONAL USE	PANACAST MEET ANYWHERE FOR FLEXIBLE GROUP USE	PANACAST 50 FOR MEETING ROOMS
<b>Video</b>	4K UHD 90 FoV Intelligent zoom Intelligent light optimization Picture-in-Picture Background Blur	Panoramic 4K 180° FoV Intelligent zoom Single Video Stream with 100% data Whiteboard camera via app	Panoramic 4K 180° FoV Intelligent zoom & Virtual Director Dynamic Composition Dual Video Stream with 100% data Embedded whiteboard camera
<b>Audio</b>	Perfect sound with Jabra Evolve2 Jabra Speak 750	Perfect sound with Jabra Speak 750	8 beam forming microphones 4 stereo speakers Full Duplex sound
<b>Safety &amp; Security</b>	On-device chipset & edge processing On-device background effects Integrated privacy lens cover SOC2 certified asset management	Safety insights SOC2 certified asset management	Safety insights Room Alerts SOC2 certified asset management
<b>Flexibility</b>	Ultra portable USB Plug & Play Certified for Microsoft Teams & Zoom Works with leading platforms	Premium Travel Case Ultra portable USB Plug & Play Certified for all leading platforms	Room occupancy insights Simple deployment Certified for all leading platforms

## JABRA SPEAK SERIES

# Make meetings easy, and collaboration simple.

Intuitive speakerphones so that you can enjoy calls that start on time without repetition or interruptions due to poor audio.



**SPEAK 410**



**SPEAK 510**



**SPEAK 710**



**SPEAK 750**



**SPEAK 810**

	SPEAK 410	SPEAK 510	SPEAK 710	SPEAK 750	SPEAK 810
<b>Class</b>	Mid-range	Mid-range	Premium	Premium	Professional
<b>Room type</b>	Small meeting room	Small meeting room	Personal office	Huddle room	Conference room
<b>Number of attendees</b>	Up to 4	Up to 4	Up to 6	Up to 6	Up to 15
<b>Full duplex</b>	No	No	No	Yes	No
<b>Talk Time</b>		Up to 10 hours	Up to 15 hours	Up to 11 hours	
<b>Omnidirectional microphone</b>	Yes	Yes	Yes	Yes	6 ZoomTalk™ microphones
<b>Range</b>		Up to 100ft/30m	Up to 100ft/30m	Up to 100ft/30m	
<b>Bluetooth</b>	No	Yes	Yes	Yes	Yes
<b>USB Bluetooth Adapter</b>	No	Yes	Yes	Yes	No
<b>Wireless</b>	No	Yes	Yes	Yes	No
<b>Link button</b>	No	No	Yes	Yes	No
<b>Microsoft Teams button</b>	No	No	No	Yes <sup>1</sup>	No
<b>Smart button<sup>2</sup></b>	Yes	Yes	Yes	Yes	No
<b>Portable</b>	Yes	Yes	Yes	Yes	No
<b>Ideal for</b>	Calls	Calls	Calls & music	Calls & music	Calls, music & multimedia

<sup>1</sup> Choose between a USB-A or USB-C variant <sup>2</sup> With ANC/busylight off





## The hybrid work model has increased our reliance on virtual collaboration.

This is why we offer everything you need to create meeting rooms that transition from in person to virtual collaboration spaces.

We can even provide experts to help select and install your equipment.

### A PanaCast 50 Conference Camera

Advanced intelligent 180° Panoramic-4K Plug-and-Play video solution. Remote connection. Manage your video devices and settings easily. 8-microphone array. Video input: Ethernet, SuperSpeed USB 3.0. Ethernet and Wifi connectivity. System requirements: Microsoft Windows 7 or later, Apple MacOS X 10.9 or later. Speakers with subwoofer. Certified for use with Microsoft Teams and Zoom. 2-year warranty. 65 x 12.5 x 8 cm. **JBR 8200-232** (828005)



### B PanaCast 180 Conference Camera

The Jabra PanaCast uses three 13-megapixel cameras and patented real-time 4k video stitching to give a full 180 P view of the room. 3840 x 1080 digital video capture resolution. 2 built-in microphones. Certified for Microsoft Teams and Zoom. Includes 1m USB-C to USB-A cable. 2-year warranty. 4 x 2.60 x 0.80 in. **JBR 8100-119** (804047)

### C PanaCast 20 Video Conference Camera

PanaCast 20 has advanced processors, powerful AI & a 13-megapixel camera delivers an impressive 4K Ultra-HD (3840 x 1080) image able to deliver more engaging presentations. Offers 13 megapixels resolution, integrated privacy cover, intelligent light optimization and intelligent-zoom. 2-year limited warranty. **JBR 8300-119** (831182)

A

B

### D PanaCast Meet Anywhere Conference System

The Meet Anywhere bundle have everything you need to transform any space into a meeting place. Includes a camera and a speakerphone, both certified Microsoft Teams. The camera offers a resolution of 720p, 1080p or 4K and the whole kit can either be placed on a desktop or mounted on a wall. 2-year limited warranty.

**With 3.3 ft. SuperSpeed USB 3.0 cable**

**JBR 8402-129** (831184)

**With 3.3 ft. SuperSpeed USB 3.0 cable and webcam stand**

**JBR 8403-129** (831185)



C

D

### E Speak 810 MS Speakerphone

This Unified Communications compatible speaker phone can easily be integrated into a variety of real-time enterprise communication services to keep you connected. The speaker itself features one 3.5mm headphone jack to connect instantly to nearly any smartphone or tablet. Bluetooth speakerphone. Zoomtalk Microphones are intelligent directional microphones that focus on human voice and not noise. Bluetooth A2DP Multimedia streaming enabled. USB, Bluetooth, and 3.5 mm connectivity for full compatibility with UC systems and VoIP Clients. Up to 15 hours Talk Time. Dimensions: 7.1 x 1.6 x 14.2 in.

**JBR 7810-109** (595439)

Wireless

### F Speak 750MS Speaker

Built-in omni-directional microphone ensures your voice is picked up clearly while the built-in speaker offers enhanced audio playback. Can be connected to your computer via a USB cable or synced to multiple devices via a Bluetooth connection. Intuitive plug and play connectivity. Portable design. Supports Bluetooth 4.2 & USB 2.0 connectivity. Up to 98 ft wireless range. Pair with up to 8 personal devices. Up to 11 hours battery runtime. 3-hour charging time. Certified for Microsoft Teams. Works with all leading UC platforms. 1-year limited warranty.

**JBR 7700-309** (828004)



E

F

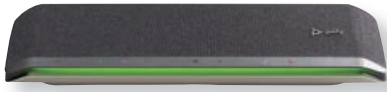

**A** poly



**B** poly



**A Sync 60 Speakers**

The Poly Sync 60 USB/Bluetooth smart speakerphone is designed for conference rooms and has incredibly powerful audio, connecting wirelessly via Bluetooth or wired via combined USB-A/USB-C cable. It is certified for Microsoft Teams and has a 6-microphone array and an acoustic echo-cancellation. With a built-in USB video camera input and intuitive features which lets you answer/end calls, mute, control the volume, pair devices and more. 2-year limited warranty. **PCY 216873-01** (831192)

**B Sync 40 Speakers**

The Poly Sync 40 USB/Bluetooth smart speakerphone is designed for your flexible workspace with remarkable sound and portability. It is certified for Microsoft Teams and has a multi-microphone array and an acoustic echo-cancellation. Intuitive features which lets you answer/end calls, mute, control the volume, pair devices and more. It weighs 310g, take 5 hours to fully charge and can run continuously for up to 30 hours. 2-year limited warranty. **PCY 218764-01** (831191)



**C** poly



**D** poly



**C Poly Sync 20+ USB/Bluetooth smart speakerphone**

Wireless speakerphone. USB-A connection. Three-microphone steerable array. Full duplex audio. Mic pickup range of 7 ft. Up to 20 hours of battery life. Works with computers via USB and smartphones via Bluetooth. Call, answer/end, mute, volume up/down and function buttons. Compatible with zoom. 1.3 x 3.7 x 7.2 in. **PCY 216867-01** (829323)

**D Sync 10 Speakers**

The Poly Sync 10 is powered through its integrated USB-A cable and works with most Windows and Mac systems without needing to install additional software drivers. A convenient USB-C adapter is included. It is also IP65 rated for dust and water resistance. It also offers noise & echo reduction, dual microphone array and touch-sensitive controls. 2-year limited warranty. **PCY 219654-01** (831190)



**E** Jabra GN



**F** Jabra GN



**E Speak 710 MS Wireless Portable Speaker**

Experience omni-directional microphone and HD voice. Ideal for voice, music and multimedia The omni-directional microphone provides 360-degree coverage and picks up sounds from any angle. HD Voice/ Wideband Audio gives you superior sound for the best voice collaboration - making sure that everyone is heard with crystal-clear clarity. In-room coverage for up to 6 people. Be mobile with a lightweight design, protective travel pouch and 15 hours battery life. Connect in seconds to laptop, smartphone and tablet via USB or Bluetooth®. **JBR 7710-309** (576595)

**F Speak 510 + MS Speakerphone**

Personal, easy-to-use conference call speakerphone with both USB and Bluetooth® connectivity for efficient and productive conference calls whenever and wherever. VoIP desktop hands-free. Built-in omni-directional microphone. Interact with your voice assistant. Digital signal processing technology and wideband audio/HD voice. With Jabra LINK 360 MS adapter. Wired USB and Bluetooth connectivity. **JBR 7510-309** (576835)



**G** Microsoft



**G Modern USB-C Speaker For Business**

Certified for Microsoft Teams, the Modern USB Type-C Speaker from Microsoft adds high-quality audio to your workspace. It seamlessly integrates with your Windows 10 or Surface system. This speaker connects to your host system using a USB Type-C connection and features an omnidirectional mic with noise reduction, and user-friendly buttons with mute control and a status light. 3-year limited warranty. **MSF 8L2-00001** (832646)

## A P21 LCD Monitor

This monitor includes a 21.5" LCD panel that supports a 1920 x 1080 resolution and up to 16.7 million colours with a 1000:1 static contrast ratio and 250 cd/m<sup>2</sup> brightness. The screen also has 89° viewing angles. With a 10W stereo speakers, a 1080p camera and a MEMS microphone. 2-year limited warranty.

**PCY 831187** (831187)



## B R30 AI-Powered Webcam

The Poly Studio R30 conference camera offers AI-powered meetings with Poly DirectorAI auto-framing and tracking technology, NoiseBlockAI and Acoustic Fence technologies as well as an advanced 3-microphone array and powerful integrated speaker. 2-year limited warranty.

**PCY 831188** (831188)

## C Poly Studio P15 Webcam

The Poly Studio P15 video bar offers exceptional optics, powerful audio, automatic camera framing, and cutting-edge noise blocking tech. With USB plug and play connectivity, beam-focusing microphone array and built-in speaker. The camera offers video modes for 720p, 1080p and 4K resolutions. 2-year limited warranty.

**PCY 831186** (831186)

## D Studio P5 Webcam And Sync20+ Speakerphone Kit

Crystal-clear audio and video in one easy to use and setup package. The Studio P5 kit contains a Studio P5 webcam with precision-tuned camera able to render a 720p or 1080p image, paired with the Sync20+ smart speakerphone which has multiple functionality and wired or Bluetooth connection. 2-year limited warranty.

**PCY 831194** (831194)

## E Blackwire Studio P5 Webcam and Headset Kit

Crystal-clear audio and video in one easy to use and setup package. The Studio P5 kit contains a Studio P5 webcam with precision-tuned camera able to render a 720p or 1080p image, paired with the Blackwire 3325 headset which has a great noise-cancelling flexible boom microphone. 2-year limited warranty.

**PCY 831193** (831193)

**A**



**B**



**C**



**D**



**E**



## See the Difference<sup>®</sup> with ViewSonic

Since 1987, ViewSonic has inspired the world to See the Difference<sup>®</sup> between the ordinary and the extraordinary.

From interactive touch displays to enterprise-class monitors and projectors, ViewSonic is proud to provide innovative, award-winning technologies that empower people to connect, create and collaborate no matter where they are.



### ViewSonic ViewBoard IFP50 series

- 4K Ultra HD resolution with flicker-free technology
- Immersive 20-point multi-touch display
- Integrated quad-core processors
- Cloud-based collaboration with myViewBoard<sup>®</sup> software
- Flexible installation options



**ViewSonic<sup>®</sup>** 

## A IFP8662 4K Interactive Monitor

Designed to help teams connect, collaborate, and create, this next-generation digital whiteboard delivers exactly what you need to move your ideas forward. A premium, state-of-the-art design features a bezel-less PCAP (projected capacitive) 86" touchscreen with incredible 4K Ultra HD resolution. 3-year limited warranty.

**VEW IFP8662** (829836)



## B IFP5550 4K Interactive Monitor

Features 4K Ultra HD resolution and an immersive 20-point touch screen, delivering incredible collaborative capabilities for boardrooms and classrooms. Pre-installed ViewSonic vBoard annotation software, this 55" interactive flat panel lets multiple users write or draw on the screen with their fingers and styluses. 3-year limited warranty.

**VEW IFP5550** (829835)

## C Ergonomic IPS Docking Monitor

Integrated gigabit Ethernet port. Latest USB-C connectivity makes dual-monitor setup a breeze and provides up to 90W power delivery to your laptop. Design features 40-degree tilt and bi-directional pivot so your screen and workspace are as comfortable as you need. 3-year limited warranty.

**VEW VG2456A** (829831)

A



B



## D ViewSonic Projection Screen

The ViewSonic PJ-SCW-1001W 48.8 x 89.4" Projection Screen has a 100" diagonal viewing area and 16:9 widescreen aspect ratio. This screen features a universal mounting bracket with endcap and a unique self-lock design. The screen can be mounted on a wall or ceiling, or can be recessed above the ceiling. 1-year limited warranty.

**VEW 829829** (829829)



## E PX701-4K Projector

The PX701-4K is a 3,200 ANSI Lumens high brightness 4K home projector. Impressive visuals in true 4K clarity supporting HDR/HLG, with 4.2ms Ultra-Fast Input and 240Hz refresh rate. Lasts 20,000 hours in Super Eco mode or 6,000 hours in normal mode. 2 HDMI ports and 10W speaker. Project an up-to-300" big screen on any surface with powerful warping, auto V keystone, H/V keystone and 4-corner adjustment. 3-year limited warranty.

**VEW PX701-4K** (829834)

C



D

## F PA503W Projector

The ViewSonic PA503W offers impressive visual performance in small business meeting rooms and classrooms. The ViewSonic PA503W projector has 3800 Lumens - 15,000 hours in Super Eco mode or 5000 hours in normal mode - 120Hz - 1HDMI - Speaker 2W. 3-year limited warranty.

**VEW PA503W** (829833)



## G M2 Mini Projector

Combining 1,200 LED Lumens, 1080p Full HD resolution, Cinema SuperColor+ Technology, dual Harman Kardon speakers within a smaller-than-A4 size, the M2 delivers superb audiovisual performance with a big screen experience on the go. 3-year limited warranty.

**VEW M2** (829832)

E



F



## H ViewSonic Universal Projector Ceiling Mount

Offers flexible projector positioning with four dual-joint support arms. It also includes a quick release connector that allows the projector to be installed quickly and then easily released for maintenance, without the need for re-alignment. 71 lb.

**VEW PJ-WMK-007** (829828)

G



H



 <p><b>A</b> poly</p> <p><b>N</b> 2023</p> <p></p>	 <p><b>B</b> logitech</p> <p><b>N</b> 2023</p> <p></p>	<p><b>A Studio P5 Webcam</b> The Poly Studio P5 webcam is a fine-tuned poly optics camera that's super easy to set up and use. It's a precision-tuned camera able to render a 720p or 1080p image. Automatic low-light compensation and brilliant colours make you look your best. 2-year limited warranty. Grey. <b>PCY 831347</b> (831347)</p> <p><b>B C930s Pro HD Webcam</b> The C930s webcam includes a high-precision lens and RightLight 2 technology to enhance video quality. HD streaming is ultra smooth with up to 60 frames per second to deliver a crystal-clear image. A 90-degree dFOV with 4x zoom allows you to control the focus. Dual mics capture your voice with exceptional clarity. USB-A Plug-and-Play. 1-year limited warranty. <b>LOG 960-001402</b> (831346)</p>
 <p><b>C</b> logitech</p> <p><b>N</b> 2023</p> <p></p>	 <p><b>D</b> logitech</p> <p><b>N</b> 2023</p> <p></p>	<p><b>C Webcaméra 4K UHD BRIO</b> The 4K UHD Brio offers the RightLight 3 and High Dynamic Range (HDR) technology and automatically adjusts to help you look professional in any lighting environment, including low light, direct sunlight or high contrast lighting conditions. Video options including 30fps 4K UHD, 60fps in 1080p or 90fps in 720p. 3-year limited warranty. <b>LOG 960-001390</b> (831345)</p>
 <p><b>E</b> logitech</p> <p><b>N</b> 2023</p> <p></p>	 <p><b>F</b> Microsoft</p> <p><b>N</b> 2023</p> <p></p>	<p><b>D C505 Webcam</b> The C505 webcam delivers crisp, smooth and colourful widescreen HD 720p video with a 60° diagonal field of view, fixed focus and auto light correction that adjusts to the illumination of any meeting space. The single, omnidirectional mic features noise-reduction technology and is engineered to support clear, natural conversation up to 3 meters away. 1-year limited warranty. Sold by each. Black engineered to support clear, natural conversation up to 3 meters away. 1-year limited warranty. <b>LOG 960-001363</b> (831344)</p> <p><b>E C922 Pro Webcam</b> The C922 Pro Webcam offers a choice of 30 fps at 1080p or hyperfast 60 fps at 720p. You can record or go live with vibrant, true-to-life HD video. Enjoy reliable no-drop audio, two omni-directional microphones, and a 78° diagonal field of view. HD autofocus and light correction. 1-year limited warranty. <b>LOG 960-001087</b> (831343)</p>
 <p><b>G</b> Microsoft</p> <p></p>	 <p><b>H</b> logitech</p> <p></p>	<p><b>F Modern Webcam For Business</b> High-quality video with HDR and True Look that deliver facial retouch, fixed light adjustment and auto focus to help you look your best. With up to 1080p video and expansive 78° field of view. Convenient plug-and-play design. Easily secure to your monitor, laptop, desk or tripod. 3-year limited warranty. <b>MSF 8L5-00001</b> (831342)</p>
 <p><b>I</b> logitech</p> <p></p>	 <p><b>J</b> logitech</p> <p></p>	 <p><b>K</b> Microsoft</p> <p></p>

**J BCC950 Conference Cam**  
Designed for small group video conferencing. Provides HD 1080p, 30 fps video. Height extender. 8 ft USB cable. A 78° field of view and 180° remote-controlled video pan, tilt, zoom ensure each member of the small group is seen. Echo cancellation. Instant plug & play with PC/Mac computers. **LOG 960000866** (373464)

**K LifeCam HD-3000 Webcam**  
720p HD video at up to 30 frames/sec. 16:9 screen. Fixed focus. Noise-cancelling microphone. Digital pan & tilt. 4x digital zoom. Universal attachment base. Broad IM compatibility. USB. **MSF T3H-00016** (208538)

**I C930e HD Webcam**  
HD 1080p video calling. 4x digital zoom. 90 degree field of view. Autofocus and automatic low-light correction. External privacy shutter. Built-in dual stereo microphones. Universal clip. **LOG 960-000971** (373472)

# Introducing the 3M™ COMPLY™ Magnetic Attach for Monitors.



**Quick-click between world-class privacy and screen sharing thanks to ultra strong magnets that click the filter securely into place.**

- **Leverages the power of rare earth magnets**  
100x stronger than refrigerator magnets
- **Proprietary modern design**  
Seamlessly attaches the privacy filter to the monitor display for a sleek, aesthetic look
- **Engineered to minimize the gap between privacy filter and screen**  
Ensuring a crisp, clear image without blurring or ghosting
- **Ingenious quick-click brackets**  
Help eliminate fingerprints by reducing the need to directly touch the privacy filter

**The Easiest Way to Attach Privacy Filters to Monitors**

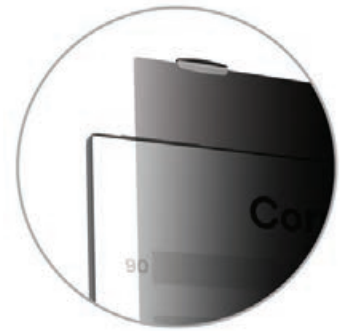

Rare earth magnets click filter securely into place.

## A COMPLY™ Privacy Filter

Effective "black out" privacy from side views outside the 60-degree viewing angle. Includes 3M™ COMPLY™ Flip Attach for Laptops to quickly and easily switch from world-class privacy to screen sharing with one simple flip. Reversible between a glossy side and glare-reducing matte.

**For laptop**

**MMM PF141W1B** (832675) 14.1 in.

**For monitor**

**MMM PF215W9EM** (832679) 21.5 in. (16:9)

**MMM PF230W9EM** (832682) 23 in. (16:9)

**MMM PF238W9EM** (832687) 23.8 in. (16:9)

**MMM PF240W9EM** (832685) 24 in. (16:9)

**MMM PF240W1EM** (832681) 24 in. (16:10)

**MMM PF245W9EM** (832683) 24.5 in. (16:9)

**MMM PF250W9EM** (832678) 25 in. (16:9)

**MMM PF250W1EM** (832684) 25 in. (16:10)

**MMM PF270W9EM** (832680) 27 in. (16:9)

**MMM PFMAP004M** (832686) Apple iMac 24 in.



**A**

## B Gold Privacy Filter for MacBook Pro®

Includes 3M™ COMPLY™ Flip Attach for Laptops to quickly and easily switch from world-class privacy to screen sharing with one simple flip. Gold, glossy finish for incredible clarity—nearly 20% more clarity than standard 3M™ black privacy filters. Reversible between vibrant gold and a glossy black screen.

**MMM GFNAP006** (832676) 13 in.

**MMM GFNAP009** (832677) 16 in.



**B**



Offers 20% more clarity than standard 3M™ black filters.

**A 3M**

**A High Clarity Privacy Filter**

Effective black out privacy from prying eyes outside a 60-degree viewing angle. Maintains the glossy clarity of your monitor screen. Glossy finish on both sides for enhanced clarity. Perfectly suited for high-resolution laptops and displays.

**For laptop**  
**MMM HC140W9B** (441055) 14 in. (16:9)  
**MMM HC156W9B** (577148) 15.6 in.

**For monitor**  
**MMM HC215W9B** (441063) 21.5 in. (16:9)  
**MMM HC220W1B** (577155) 22 in.  
**MMM HC230W9B** (577205) 23 in.  
**MMM HC240W9B** (577163) 24 in.  
**MMM HC240W1B** (441071) 24 in. (16:10)  
**MMM HC270W9B** (577171) 27 in.



Offers twice the protection of a black filter.

**B 3M**

**B Gold Privacy Filter**

Bright gold surface keeps onlookers away and protects your data. Provides sharper text and images without blurring or distortion. Easy to install and remove. Remains in place when the laptop is closed. Reversible. For large screens.

**For laptop**  
**MMM GF133W9B** (169359) 13.3 in.  
**MMM GF156W9B** (237354) 15.6 in.

**For monitor**  
**MMM GF215W9B** (577189) 21.5 in.  
**MMM GF220W1B** (577197) 22 in.  
**MMM GF230W9B** (577213) 23 in.



**C 3M**

**C Black Privacy Filter**

Only the user can see on-screen documents. From the side, others see a dark, blank screen. Filter can remain in place even when computer is closed.

**For laptop - without frame**  
**MMM PF125W9B** (189696) 12.5 in. (16:9)  
**MMM PF13-3W9** (189704) 13.3 in. (16:9)  
**MMM PF140W9B** (189712) 14 in.  
**MMM PF156W9B** (189787) 15.6 in.

**For monitor - without frame**  
**MMM PF170C4B** (701581) 17 in.  
**MMM PF19-0** (720789) 19 in.  
**MMM PF200W9B** (189837) 20 in. (16:9)  
**MMM PF215W9B** (189845) 21.5 in.  
**MMM PF220W1B** (784751) 22 in. (wide)  
**MMM PF230W9** (322040) 23 in. (16:9)  
**MMM PF240W** (121905) 24 in. (wide)  
**MMM PF240W9B** (322065) 24 in. (16:9)  
**MMM PF270W9B** (1012939) 27 in.  
**Widescreen - with black frame**  
**MMM PF220W1F** (145946) 22 in.  
**MMM PF324W** (145953) 24 in.



**D Fellowes**

**D PrivaScreen™ Privacy Filter**

Darkens screen image when viewed from a 30° side angle; on-screen data is easily visible from a straight-on view. Protects screen from fingerprints and scratches, and reduces glare to help prevent eye strain. Easy to attach and remove.

**Laptop, widescreen**  
**FEL 4812001** (286187) 14 in.

**Monitor, standard**  
**FEL 4800501** (145821) 19 in.

**Monitor, widescreen**  
**FEL 4807001** (237065) 21.5 in.

**FEL 4801501** (121848) 22 in.

**FEL 4807101** (283663) 23 in.

**FEL 4816901** (571919) 23.8 in.

**FEL 4811801** (286179) 24 in. (16:9)

**FEL 4801601** (121855) 24 in. (16:10)

**FEL 4815001** (571943) 27 in.



**E Kensington**

**E Snap2™ Privacy Screen for Monitors**

Hard coated film. Narrows viewing angle to shield confidential data from on-lookers. Textured surface with light tint minimizes glare and improves contrast and colour. Frame-free construction, no adhesive required.

**Standard screen**  
**KMW 8589655776** (145706) 17 in.

**Widescreen**  
**KMW 8589655778** (145722) 19 in.

**KMW 8589655779** (145730) 22 in.

**KMW 8589655315** (434084) 22-24 in.





**We have the software you need.**

Our selection is updated as new versions are released.  
Check our website for the latest releases.

**A Microsoft Windows 11 Professional Operating System**

Windows 11 is designed for hybrid work. Windows 11 Pro delivers a powerful, streamlined user experience that helps you stay focused and get more done – wherever your office might be.

**MSF HAV-00162** (832425) English  
**MSF HAV-00156** (832424) French



**B Microsoft Windows 11 Home Operating System**

Windows 11 is the one place for it all. With a fresh new feel and tools that make it easier to be efficient, it has what you need for whatever's next.

**MSF HAJ-00108** (832423) English  
**MSF HAJ-00110** (832422) French

**C Microsoft Project Professional 2021**

Manage your projects more efficiently with the right timelines, budgets, and resources.

**MSF H30-05950** (832421) English  
**MSF H30-05953** (832420) French

**D Microsoft Project Standard**

Use tools you know like Gantt charts to create schedules with ease and reduce training time. Built-in multiple timelines let you visually represent complex schedules and understand all aspects of a project.

**MSF 076-05916** (832419) English  
**MSF 076-05918** (832418) French

**E Microsoft Visio Professional**

Work as a team to easily create and share data-linked diagrams to bring your ideas to life.

**MSF D87-07619** (832417) English  
**MSF D87-07622** (832416) French

**F Microsoft Visio Standard**

Easily create versatile diagrams, organization charts, maps, workflows, and home or office plans using a rich set of shapes and templates.

**MSF D86-05954** (832415) English  
**MSF D86-05957** (832414) French

**G Microsoft Office Home & Student 2021**

Full versions of Microsoft Word, Excel, and PowerPoint, plus additional OneNote features on a single Windows or Mac computer. For 1 User.

**MSF 796-05396** (832411) English  
**MSF 796-05404** (832409) French

**H Microsoft 365 Business Standard - 1 Year Subscription**

Full versions of Microsoft Word, Excel, PowerPoint, Outlook, OneNote, Publisher, and Access, as well as OneDrive, Exchange, and SharePoint. For 1 user.

**MSF KLQ-00659** (832408) English  
**MSF KLQ-00671** (832407) French

**I Microsoft 365 Family - 1 Year Subscription**

Full versions of Microsoft Word, Excel, PowerPoint, Outlook, OneNote, Publisher, and Access. 1-6 users.

**MSF 6GQ-01565** (832406) English  
**MSF 6GQ-01575** (832405) French

**J Microsoft 365 Personal - 1 Year Subscription**

Full versions of Microsoft Word, Excel, PowerPoint, Outlook, OneNote, Publisher, and Access. For 1 user.

**MSF QQ2-01407** (832404) English  
**MSF QQ2-01417** (832403) French



**K NordVPN Internet Privacy Software - 1 Year Subscription**

A Virtual Private Network (VPN) will keep your traffic secure in a tunnel between your device and the internet. This tunnel is protected by next-generation encryption.

For 6 devices.  
**NVP 832401** (832401)

**L Microsoft Office Home & Business 2021**

OfficeSuite Home & Business is the. Enjoy 5 feature-rich apps for working with documents, spreadsheets, presentations, PDFs, and mail, plus advanced cloud integration and an event calendar. For 1 user.

**MSF T5D-03518** (828066) English  
**MSF T5D-03525** (828065) French

## JABRA EVOLVE2 SERIES

# It's our most advance range of headsets yet.

Designed to boost productivity and aid concentration and collaboration in the face of ever-increasing challenges.



EVOLVE2 85

EVOLVE2 75

EVOLVE2 65

EVOLVE2 40

EVOLVE2 30

	EVOLVE2 85	EVOLVE2 75	EVOLVE2 65	EVOLVE2 40	EVOLVE2 30
<b>Connectivity<sup>1</sup></b>	Desk phone	• <sup>2</sup>	• <sup>2</sup>	• <sup>2</sup>	• <sup>2</sup>
	Softphone	•	•	•	•
	Mobile	•	•	•	•
	Wireless	•	•	•	
	Corded				•
<b>Wearing style</b>	Stereo	•	•	•	•
	Mono			•	•
	Over-ear headband	•			
	On-ear headband		•	•	•
<b>Concentration</b>	Active Noise Cancellation	•	•		
	Busylight	•	•	•	•
	HearThrough	•	•	•	
<b>Talk/Music time</b>	Up to - hours	26/37 <sup>2</sup>	26/37 <sup>2</sup>	35/37 <sup>2</sup>	
<b>Wireless range</b>	Up to - m/ft	30/100	30/100	30/100	

<sup>1</sup> Choose between a USB-A or USB-C variant <sup>2</sup> Can direct connect into desk phones which have USB audio passthrough according to Jabra compatibility guide. Or Legacy desk phones using Jabra Link 950 Adapter.

## JABRA ENGAGE SERIES

# More power for your conversations.

The Engage Series is designed to suit the needs of call centric workers who talk and listen to customers on the phone.

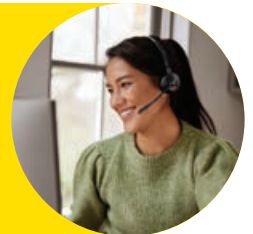

ENGAGE 75

ENGAGE 75 CONVERTIBLE

ENGAGE 65

ENGAGE 65 CONVERTIBLE

ENGAGE 55

ENGAGE 55 II CONVERTIBLE

ENGAGE 50

ENGAGE 50 II

ENGAGE 40

	ENGAGE 75	ENGAGE 75 CONVERTIBLE	ENGAGE 65	ENGAGE 65 CONVERTIBLE	ENGAGE 55	ENGAGE 55 II CONVERTIBLE	ENGAGE 50	ENGAGE 50 II	ENGAGE 40	
<b>Connectivity<sup>4</sup></b>	Desk phone	•	•	•	• <sup>11</sup>	• <sup>11</sup>	•			
	Softphone	•	•	•	•	•	•	•	•	
	Mobile	•	•			• <sup>3</sup>	• <sup>3</sup>	• <sup>3</sup>	• <sup>3</sup>	
	Multi-device connectivity	5 <sup>4</sup>	5 <sup>4</sup>	2 <sup>5</sup>	2 <sup>5</sup>	1 <sup>6</sup>	1 <sup>6</sup>	1 <sup>6</sup>	1 <sup>6</sup>	
	Wireless (DECT)	•	•	•	•	•				
	Corded	• <sup>12</sup>	• <sup>12</sup>	• <sup>12</sup>	• <sup>12</sup>	• <sup>12</sup>	• <sup>12</sup>	•	•	•
	Device pairing	• <sup>13</sup>	• <sup>13</sup>	• <sup>13</sup>	• <sup>13</sup>	• <sup>13</sup>	• <sup>13</sup>			
<b>Wearing style</b>	Stereo	•		•	•		•	•	•	
	Mono	•		•	•		•	•	•	
	Headband	•	• <sup>7</sup>	•	•	•	•	•	•	
	Earhook		• <sup>7</sup>		•	•				
	Neckband	• <sup>8</sup>	• <sup>7</sup>	• <sup>9</sup>	• <sup>9</sup>	•				
	Adjustable boom arm	270°	360°	270°	360°	270°	270°	300°	270°	270°
<b>Concentration</b>	Noise cancelling microphone	•	•	•	•	•	•	•	•	
	Busylight	•	•	•	•	•	•	•	•	
<b>Talk time<sup>10</sup></b>	Up to - hours	13	9	13	9	13 <sup>14</sup>	9			
<b>Wireless range</b>	Up to - m/ft	150/490	100/330	150/490	100/330	150/490	150/490			

<sup>3</sup> With USB-C connectivity <sup>4</sup> Can connect to 2 USB devices (softphone and/or desk phone), 2 Bluetooth® devices and 1 analog desk phone <sup>5</sup> Can connect to 1 USB device (softphone or desk phone) and 1 analog phone <sup>6</sup> Can connect to 1 USB device (softphone or desk phone) at a time <sup>7</sup> Comes with earhook, neckband or headband <sup>8</sup> Engage 75 Mono comes with neckband accessory <sup>9</sup> Engage 65 Mono and Engage 65 Convertible: neckband is available as an accessory <sup>10</sup> Dependent on usage <sup>11</sup> Specific desk phones to date <sup>12</sup> Headset directly to PC via wired connection <sup>13</sup> Conference up to 3 additional headsets on calls <sup>14</sup> Stereo and mono

## A Evolve2 65 Phone Headset

Advanced digital chipset that's three times more powerful and three strategically placed professional microphones, filtering out 23% more background conversation noise. Passive Noise Cancellation. In-use indicator light. USB or Bluetooth connection. Full charge time 90 minutes (up to 37 hours of battery). Fast charge in 15 minutes (up to 8 hour of battery). Optimized for Microsoft®.

### USB-A

**JBR828525** (828525) stereo

### USB-C

**JBR 832663** (832663) mono

**JBR 832666** (832666) stereo

**USB-A with charging stand**

**JBR 832664** (832664) mono

**JBR 832667** (832667) stereo

**USB-C with charging stand**

**JBR 832662** (832662) mono

**JBR 832665** (832665) stereo



**A**



**B**

## B Evolve2 75 Wireless Stereo Headset

Communicate wirelessly without distractions with the Evolve2 75 MS Noise-Canceling Wireless Headset from Jabra. Utilizing wireless Bluetooth technology, you can take important calls from your desk or while walking. Jabra incorporated dual-foam technology for the ear cushions to maximize passive noise isolation and assist with active noise cancellation. 2-year limited warranty.

### USB-A

**JBR 832661** (832661)

### USB-C

**JBR 832659** (832659)

**USB-C with charging stand**

**JBR 832660** (832660)



**C**



**D**

## C Evolve2 85 Wired Or Wireless Stereo Headset

Features hybrid active noise cancellation (ANC) technology. Accessible answer/end call, mute, next/previous, play/pause, volume control and voice assistant buttons. It comes with a charging stand, a 1.2m 3.5mm audio cable and a USB-C Bluetooth adapter. It weighs 286g, takes 2.5 hours to charge and can be used continuously for up to 37 hours. 2-year limited warranty.

### With charging stand

**JBR 832657** (832657) USB-C

**JBR 832658** (832658) USB-A

### Without charging stand

**JBR 832655** (832655) USB-A

**JBR 832656** (832656) USB-C



**E**



**F**



## D PRO 920 Wireless Stereo Headset

Comes with a pre-connected charging base. It comes with a noise-cancelling boom microphone that also avoids air shocks as well as accessible answer/end call, mute and volume control buttons. It weighs 80g and can be charged in 3 hours for up to 8 hours of continuous use in a 120m radius. 2-year limited warranty.

**JBR 832674** (832674)



**G**



**F**



**F**



## E Engage 55 MS Mono Wireless Headset

A DECT wireless headset featuring improved noise-cancelling technology and microphone performance. The Engage 55 has answer/end call, mute and volume control buttons as well as a busy light to let everyone know you are on a call. The headset comes with its charging station, connecting with a USB-A cable. Weighing 57g, it can run continuously for up to 13 hours in a 150m range. 1-year limited warranty.

### USB-A

**JBR 9553455125** (832650) mono

**JBR 9559455125** (832648) stereo

**JBR 9555450125** (832651) convertible

### USB-C

**JBR 9553475125** (832649) mono

**JBR 9559475125** (832647) stereo

## F Engage 65 Convertible Wireless Headset

Comes with its own charging station and offers accessible answer/end/reject call, mute and volume control buttons. It features a status indicator and a noise-cancelling boom microphone. Weighing 18g, it takes 75minutes to fully charge and can work continuously for up to 9 hours in a range of 100m. 1-year limited.

**JBR 9555553125** (832652)

## G Engage 75 Convertible Wireless Headset

Comes with its own touchscreen charging station and offers accessible answer/end/reject call, mute and volume control buttons. It features a status indicator and a noise-cancelling boom microphone. Weighing 18g, it takes 75 minutes to fully charge and can work continuously for up to 9 hours in a range of 100m. 1-year Limited warranty.

**JBR 9555583125** (832653) mono convertible

**JBR 9559583125** (832654) stereo



**G**





**A**



**B**

**N**  
2023

**A Savi 7200 Office Wireless Headset**

Wireless roaming up to 400ft line of sight, 180 ft in a typical office. Flexible microphone boom arm. Noise canceling mic. 64 bit encryption DECT Security Certified. Conference additional 3 Savi 7200 series headsets for conference or training calls. Connection : wireless DECT technology, No Wi-Fi interference. 12 hours talk time on a single charge (50 hours of standby). 3 hour charge time. SoundGuard protects against sound levels above 118 dBA. Anti-startle detects and eliminates any large sudden increase in signal level. Headset weight 138 g. Remote answering with lifter (HL10) or electronic hook switch module (EHS), sold separately. Sold by each.

**PLN 213010-01** (806497) mono  
**PLN 213020-01** (808352) stereo

**B Savi 8200 Office Wireless DECT Headset**

Offers a wireless range of up to 180m with noise-canceling, Hi-Fi stereo sound support. It also features an all-in-one charging base with 3-way connection to a PC, mobile phone, and desk phone. Accessible answer/end call, mute and volume control buttons. It weighs 115g, takes 3 hours to fully charge and can function continuously for up to 13 hours. 1-year limited warranty.

**For UC applications and softphones**  
**PLN 207309-01** (587592) mono  
**PLN 207325-01** (584318) stereo  
**Optimized for Microsoft®**  
**PCY 207322-01** (832640) mono  
**PCY 207326-01** (832641) stereo



**C**

**N**  
2023



**D**



**E**

**N**  
2023

**C Savi 8200 UC Wireless DECT Headset**

Comes with its charging port and a microUSB Bluetooth adapter. It features dedicated mute, call answer/end and volume controls as well as a noise-cancelling microphone. Weighing 115g, it takes 3 hours to fully charge and can run continuously for up to 13 hours in a range of 180m. 2-year limited warranty.

**For UC applications and softphones**  
**PLN 209213-01** (1003656) mono  
**Optimized for Microsoft®**  
**PCY 209212-01** (832637) mono  
**PLN 209214-01** (1003664) stereo

**D Savi 8240 UC Wireless Headset**

Includes D200 USB-A adapter. Wireless range up to 300ft. DECT 6.0 technology provides best-in-class audio; eliminates interference from Wi-Fi. With one-touch call answer/end, vol+/-, mute and flash, switch between softphone calls for simple call management. Up to 7 hours of talk time, 30 hours standby. Adaptive power system, delivers longer talk and standby times.

**PLN 211200-01** (807859) standard  
**PLN 211201-01** (806588) optimized for Microsoft®

**E Savi 8245 UC Wireless Headset**

Comes with its charging port which connects to your PC via a USB-A cable. It features dedicated mute, call answer/end and volume controls as well as a noise-cancelling microphone. Weighing 21g, it takes 3 hours to fully charge and can run continuously for up to 7 hours in a range of 180m. 2-year limited warranty.

**PCY 211204-01** (832639)

**F Savi 88245 MS Wireless Headset**

Comes with its charging port which connects to your PC via a USB-A cable. It features dedicated mute, call answer/end and volume controls as well as a noise-cancelling microphone. Weighing 21g, it takes 3 hours to fully charge and can run continuously for up to 7 hours in a range of 180m. 2-year limited warranty.

**PCY 214900-01** (832638)



**F**

**N**  
2023



**G**

**G CS540 Headset System**

Wireless convertible headset (3 wearing styles). One-touch call control, volume and mute button. Digital encryption. Noise-cancelling microphone. Wideband audio support. Extended talk time up to 6 hours. Fast charging.

**CS540. 1.9 GHz DECT, up to 300'**  
**PLNCS540** (266767)  
**CS540XD. 900 MHz, up to 350'**  
**PLN88283-01** (264960)  
**CS540 with handset lifter. 1.9 GHz DECT, up to 300'**  
**PLN84693-11** (264739)

**H S12 Phone System**

Over-the-head and over-the-ear convertible headset. Adjustable headband. Noise-cancelling microphone. In-use indicator light on the boom. Headset on/off switch. Built-in amplifier. Can be connected to single- or multi-line phones.

**PLNS12** (776146)



**H**

## A Voyager Legend Bluetooth Headset

For right ear. In-ear, over the ear mount. Wireless. Announces incoming caller's name and lets you say "answer" to accept the call or "ignore" to decline. Tap the voice button to check battery level, connection status, or dial Vocalyst to hear emails, newsfeeds, and more. Protected against sweat and moisture damage by P2i technology.  
**PCY 87300-203** (807628)



## B Voyager 5200 UC B Headset

Earbud with over-the-ear mount. Activate Siri, Google Now or Cortana with the touche of a button on the headset. Whispered alerts update you on talk time, and even announce the names of incoming callers so you can simply say "Answer" or "Ignore" to calls without lifting a finger. 4-mic noise cancelling. WindSmart® technology eliminates disruptive background noise like wind and chatter. Range of 30 m.  
**PLN 206110-101** (423822)



## C B825 Wireless Voyager Focus Headset

Stereo Bluetooth headset comes with its charging cable and a microUSB Bluetooth adapter. Designed to move fluidly between PC and smartphone it features active noise canceling cushions and three precision-tuned microphones. Easy to use answer/end call, mute, play/pause and volume control buttons are all accessible. Able to run continuously for up to 15 hours in a 30m range, it weighs 155g. 2-year limited warranty.

**For UC applications and softphones**  
**PCY 202653-102** (832635) without stand  
**PLN 202652-102** (810192) with stand  
**Optimized for Microsoft®**  
**PCY 202652-104** (832636) without stand  
**PCY 202652-106** (832634) with stand



## D Voyager 5200 Office USB-A Headset

Connects to your desk phone via telephone interface or EHS cable and to your PC/Mac via USB cable. Active noise canceling, mute, volume, answer/end, play/pause, next/previous track, reject call and redial controls. Base station and charging cable (USB) included. Up to 7 hour(s) of run time. Recharge Time of 1.5 hour(s). 0.71 oz.  
**PLN 212732-01** (806562)

## E Voyager 8200 UC Headphones

Bluetooth. Soft ear cushions, 24 hours of listening time and 3.5 mm audio cable allowing to play 98 ft with a Class 1 Bluetooth device. Hi-fi stereo sound and dual-mode active noise canceling cut background noise. Button dedicated to give quick access to mute.  
**PCY 208769-01** (828984)



## F Voyager Focus 2 Headset

On ear. Active noise canceling with "focus zone". Three levels of hybrid active noise canceling (ANC). Acoustic Fence technology eliminates background noise. Connect to a computer with the included BT700 USB-A adapter and to a mobile via Bluetooth v5.1. Keep your headset fully charged at all times using a desktop charging stand.

**For UC applications and softphones**  
**PCY 213727-02** (828981) stereo  
**Optimized for Microsoft®**  
**PCY 218470-02** (828477) mono  
**PCY 213726-02** (828478) stereo

## G Microsoft Modern Wireless Headset

Features a noise-reducing boom microphone, on-ear call controls for Microsoft Teams calls and a status light that allows you to easily see whether you can be heard or not. The headset weighs 136g, comes with a USB charging cable and a USB dongle, takes 2.5 hours to charge and can run continuously for up to 50 hours in a 30m range. 1-year limited warranty.  
**MSF 8JS-00001** (832644)

## H GO Air True Wireless Earbuds

Slimmer profile. Case with strong magnet secures the buds especially when you are on-the-go. Pocket friendly case features an integrated charging cable for on-the-go. Features touch controls and dual connect, allowing the earbuds to be used independently. Bluetooth connection. Long battery life. Features 5 hours of playtime in each earbud and 15+ extra hours from the charging case. A built-in MEMS microphone in each bud ensures clear calls. EQ3 Sound.

**JLA804666** (804674) white  
**JLA804674** (804666) black





**A**



**B**



**A Evolve2 30 MS Wired Headset**

Features a boom microphone and accessible mute and volume control buttons. It weighs 102g and comes with a 1.5m cable. 2-year limited warranty.

- USB-A**
- JBR 831197** (831197) mono
- JBR 831196** (831196) stereo
- USB-C**
- JBR 831202** (831202) mono
- JBR 831203** (831203) stereo

**B Evolve2 40 MS Wired Headset**

Isolating oval memory foam ear cushion and an angled ear cup design to maximize passive noise isolation. The headset features a flexible boom microphone and buttons to answer/end calls, mute and control the volume. It weighs 113g and comes with a 1.5m cable. 2-year limited warranty.

- USB-A**
- JBR 828522** (828522) mono
- JBR 828523** (828523) stereo
- USB-C**
- JBR 831198** (831198) mono
- JBR 831200** (831200) stereo

**C Evolve 80 MS Wired Stereo Headset**

Offers a smartphone connectivity (USB or 3.5mm), Active Noise Cancellation (ANC) to filter out low-frequency background noise and an integrated red lights on both ear cups that are activated automatically when on a call or manually by the user at any other time. The full length USB cable is 7ft long and can be adjusted to a 3.1ft 3.5mm cable. The headset weighs 328g. 2-year limited warranty.

- JBR 7899823109** (831216) USB-A
- JBR 7899823189** (831217) USB-C



**C**



**D**



**D BIZ 2300 Wired Headset**

Offers HD voice speaker performance and a noise cancelling flexible boom microphone. This headset is UC compatible and features dual stereo speakers with a 77ft QD cable allowing connection to desk phones. 2-year limited warranty.

- QD wideband**
- JBR 2383820109** (831225) mono
- JBR 2389820109** (831226) stereo
- USB-A**
- JBR 2393823109** (831218) mono
- JBR 2399823109** (831219) stereo
- USB-C**
- JBR 2393823189** (831220) mono
- JBR 2399823189** (831221) stereo

**E BIZ 2400 LI Wired Headset**

World class sound, with breath-resistant microphone, ultra noise cancellation that eliminates background noise, and HD voice and HiFi sound deliver superior sounding calls and music. Best-in-class, durable build, with reinforced cord and larger ear cushions for passive noise protection. 40% lighter than competitors, soft pouch leatherette ear cushions, headphone padding and 360-degree flexible spin boom arm for ultimate comfort. 2-year limited warranty. Sold by each. Black

- QD wideband**
- JBR 2409820205** (831224) stereo
- USB-A**
- JBR 2496823309** (831223) mono
- JBR 2499823309** (831222) stereo



**E**



## A Blackwire 3300 Series Headset

Comfortable USB headset for your computer. Supports long-wearing comfort with a comfortable, padded headband and pillow soft ear cushions. Adjustable 180-degree pivoting speakers. Flexible, bendable boom arm. Apple Mac OS and Microsoft Windows compatible. HD wideband audio quality. Noise-canceling microphone. 94 dB SPL ± 4 dB speaker sensitivity. Impedance 32 ohm. SoundGuard: Acoustic limiting for protection against sounds above 118 dBA. G616 support limits the level to 102 dB SPL. 100 Hz to 10 kHz optimized for PC wide band audio up to 6.8 kHz microphone frequency response.

### USB-A

PLN 213936-01 (806547)

PCY 213938-101 (831229) stereo

### USB-C

PLN 213929-01 (806539) mono

PLN 214013-101 (806513) stereo



A

B

## B Encorepro 540 Convertible Headset

High-quality audio and a flexible mic with visual positioning guides. Quick disconnect feature. Set of 3 headsets.

PLN 88828-01 (353623)

## C EncorePro 710 / 720 Headset

Ultra-slim design with satin finish. Soft and comfortable leatherette earpad. Adjustable headband. Quick disconnect feature for walkaway convenience. Wideband audio. Extensible boom with noise cancellation. Compatible with USB audio processors and direct connect cables. Sold by each.

PLN 78712-101 (338392) mono

PLN 78714-101 (338400) stereo

## D EncorePro 510/520 Headset

Over-the-head. Designed for telephone-intensive users, including formal customer care centers, help desks, telesales, and customer service organizations. Advanced noise-canceling microphone. Tactile and visual guidance mean the user can feel and hear ratchet clicks when the boom is moved into the proper range. Unibody flexible boom and laser welding ensure maximum robustness. QuickDisconnect feature provides walk away convenience. Soft, luxurious ear cushions for all-day comfort. Sold by each. Black.

### Noise cancelling

PLN 89433-01 (549055) mono

PLN 89434-01 (557181) stereo

### With voice tube

PLN 89435-01 (597542) mono

PLN 89436-01 (597534) stereo

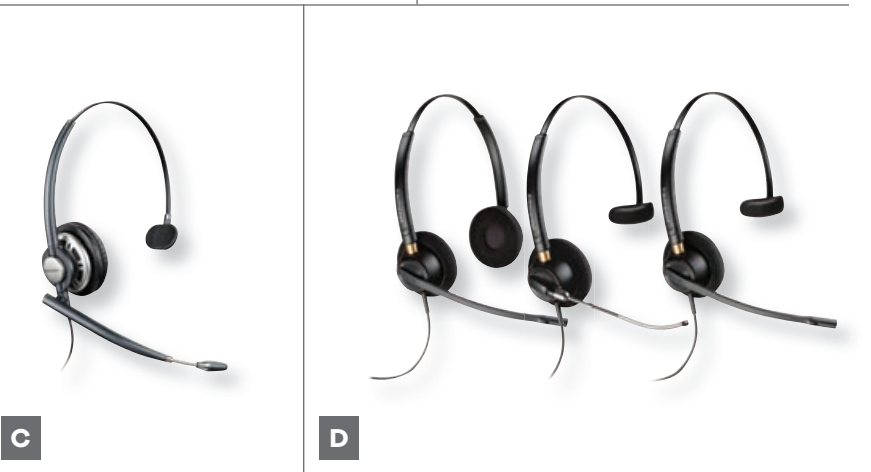

C

D

## E Blackwire 5200 Series Phone Headset

Ergonomically designed, it's comfortable enough to wear all day, on your longest calls. Soft, conforming ear cushions provide passive noise canceling, while a precisely tuned microphone masks nearby conversations. Dedicated, customizable mute settings allow you to take calls confidently, ensuring you're always heard. Intuitive in-line controls to answer/end calls and control volume. The dynamic EQ feature optimizes your voice quality when you're on a call. United Communication compatible. 3.5 mm jack plug. USB-A connectivity.

### USB-C

PLN 207577-01 (575985) mono

PLN 207576-01 (575993) stereo

### USB-A

PLN 207587-01 (698761) mono

PLN 207586-01 (694992) stereo

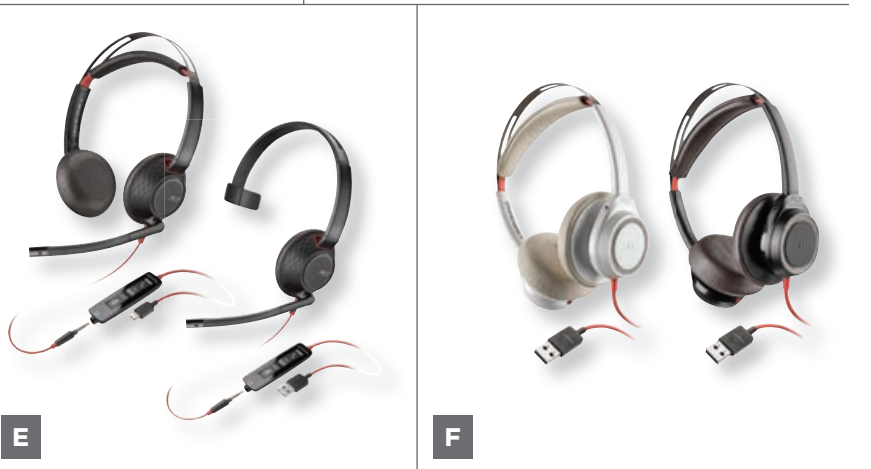

E

F

## F Blackwire Headset 7225

Active noise-canceling technology helps block out distracting sound. Four microphones separate your voice from the background noise. Includes either PC/MAC connectivity with either universal USB-A or USB-C type connectivity. Corded, lightweight and stylish. With hi-fi stereo sound. Sold by each.

### USB-A

PLN 211144-01 (595082) black

PLN 211154-01 (595074) white

### USB-C

PLN 211145-01 (595066) black

PLN 211155-01 (595058) white

## G Blackwire 8225 Wired Stereo Headset

Features a swivel boom microphone with four integrated digital microphones and Acoustic Fence and hybrid active noise cancellation technologies. The headset weighs 185g with its 7ft USB-A cord with which it can connect to any PC and most desk phones. It also features buttons for call answer/end, mute, volume up and down as well as ANC off, mid or high. 2-year limited warranty.

PCY 214408-01 (831230)



G





**A**



**B**

**A Microsoft Modern Wired Headset**  
 Connect seamlessly to your Surface or other Windows PC. Featuring a noise-reducing boom microphone and buttons to answer/end call, mute and control the volume, this headset weighs 142g and has a 5ft USB-A cable. 1-year limited warranty.  
**MSF 6IG-00001** (832643) USB-A  
**MSF I6S-00011** (832642) USB-C

**B LifeChat LX-3000 PC Headset**  
 Free worldwide Internet calling to your online contacts (through Windows Live Messenger or MSN Messenger). Leatherette ear pads. Noise-cancelling microphone. Audio/call switch. USB. 1.8 m cord.  
**MSF JUG-00016** (164046)



**C**

**C H390 USB Headset**  
 Features plush ear pads and adjustable padded headband. Noise-cancelling microphone rotates out of the way when you're not using it. USB-A.  
**LOG 981-000014** (219220)

**D H340 Headset**  
 Lightweight, plug-and-play USB headset. Flexible headband and microphone.  
**LOG 981000507** (257832)

**E H540 USB Headset**  
 Noise-cancelling microphone. Discreet boom can be tucked inside the headband and out of the way when you're not using it. Adjust the volume or mute your calls with simple on-ear controls located on the right ear cup. Soft, padded leatherette headband and ear cups. USB.  
**LOG 981000510** (576074)

**F H111 Stereo PC Headset**  
 Boom can rotate 180° to be worn on the left or right. Boom can be tucked out of the way when you're not using it. Broad range of adjustment. Ultra-soft foam ear cushions provide hours of comfort. Cable length: 1.8 m. 3.5 mm auxiliary connection.  
**LOG 981-000612** (584268)



**D**



**E**

**G H650E Stereo Headset**  
 Features digital signal processing, acoustic echo cancellation, wideband audio, dynamic equalizer, and noise-cancelling mic. A flat, no-tangle cable connects to the USB port on a Mac or PC for plug-and-play simplicity. USB.  
**LOG 981-000518** (576082)



**F**



**G**



## A Cobra PX650 Two-Way Radio

The Cobra PX650 Pro Business 2-Watt FRS walkie-talkies are ideal for larger business use and have a range up to 300,000 sq. ft./25 floors. With a Push-To-Talk button, dedicated volume/channel knobs, and a Waterproof (IPX4) Rating. Up to 18 hours of continuous usage (90% stand-by). 1-year limited warranty.

**CEC PX650** (831250)

## B Cobra RX680 Two-Way Radio

The Cobra RX680 are a pair of waterproof walkie-talkies with up to a 38-mile range, Waterproof (IP54) Rating, NOAA Weather Alerts, built-in LED flashlight, and more. Up to 18 hours of continuous usage (90% stand-by). 1-year limited warranty.

**CEC RX680** (831251)

## C Cobra Two-Way Radio

With up to 37-mile range, Waterproof (IP67) Rating and floating design, NOAA Weather Alerts, Rewind-Say-Again and more advanced features, the ACXT1035R FLT allows clear communication practically anywhere. 1-year limited warranty. 8-hour battery life.

**CEC 831252** (831252)

## D Cobra ACXT145 Two-Way Radio

Each Cobra walkie-talkie radio has 10 weather presets to quickly check storm conditions and uses 22 FRS/GMRS channels to avoid interference from other units. They use NIMH batteries, which recharge with a microUSB cable. Up to 16 miles of range (range depends on terrain and conditions). 5-hour battery life. 1-year limited warranty.

**CEC ACXT145** (831254)

## E Cobra ACXT145-3 Two-Way Radio

Each Cobra walkie-talkie radio has 10 weather presets to quickly check storm conditions and uses 22 FRS/GMRS channels to avoid interference from other units. They use NIMH batteries, which recharge with a microUSB cable. Up to 16 miles of range (range depends on terrain and conditions). 5-hour battery life. 1-year limited warranty.

**CEC ACXT145-3** (831255)

**Cobra**



**A**



**B**



**C**



**D**



**E**



The MagSafe Charger is designed to quickly and safely wirelessly charge your iPhone. The system intelligently adapts to conditions in order to optimize charging your iPhone at up to 15W of peak power delivery for faster wireless charging.



**A** blu-element



**B**

**A MagSafe Compatible Smart Phone Case**

**Armour 2X - black**  
**BEE 832485** (832485) iPhone 13  
**Rugged DropZone - clear**  
**BEE 832493** (832493) iPhone 13  
**BEE 832509** (832509) iPhone 13 Pro  
**BEE 832500** (832500) iPhone 13 Pro Max

**B MagSafe Compatible Smart Phone Case**

For iPhone 13 Pro Max. Limited lifetime warranty. Recycled content: Commuter (35%), Symmetry (50%).  
**Commuter**  
**OBX 77-83451** (832502) black  
**Symmetry**  
**OBX 77-83483** (832505) black  
**OBX 77-83506** (832504) clear

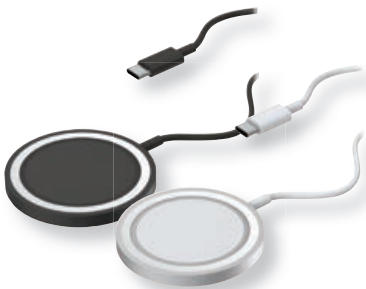

**C**



**D**

**C Charging Pad for iPhone**

15W Qi-compatible wireless charger delivers optimal 7.5W charging speeds. 6.6 ft integrated USB-C cable powers pad. Designed for seamless interaction with MagSafe technology. Limited lifetime warranty.  
**ACO UMUV6AA006** (828446) black  
**OBX 7880632** (828445) white

**D MagSafe Wireless Charging Pad**

Wireless charger is MagSafe compatible, built with strong magnets that hold devices securely in place while charging. With a sleek fabric design with 6ft USB-C cable included.  
**BEE BEMSCHB** (832450) black  
**BEE BEMSCHG** (832449) grey



**E**



**F**

**E Charger Stand for MagSafe**

Streamlined design creates ideal iPhone resting place. Wirelessly powers iPhone at 7.5 watts. Stand is powered by fast charging 20W wall charger and 6.6ft USB-C to USB-C (included).

**For phone only**  
**OBX 78-80564** (832453) black  
**OBX 78-80635** (832454) white  
**3 in one charging station**  
**OBX 78-80565** (832451) black  
**OBX 78-80533** (832452) white

**F Car Vent Mount for MagSafe**

Designed for seamless interaction with MagSafe technology. Strong magnetic alignment and attachment. Adjusts easily for optimal viewing and access. Holds phone securely in landscape and portrait positions. Black.  
**OBX 78-80445** (828447)



**G**

**G Wireless Car Charger for MagSafe**

Designed for seamless interaction with MagSafe technology. Strong magnetic alignment and attachment. 15W Qi wireless charger delivers optimal 7.5W charging speeds. Adjusts easily for optimal viewing and access. Holds phone securely in landscape and portrait positions. Black.

**Car vent mount**  
**OBX 7880532** (828448)  
**For dashboard or windshield**  
**OBX 78-80531** (832483)



Our selection is updated as new versions are released.  
Check our website for the latest selection of smart phone cases.

## A Defender Smart Phone Case

Updated slimmer design, same rugged protection and drop performance. Multi-layer defense with a solid inner shell and resilient outer slipcover. Port covers prevent dirt, dust and lint from clogging jacks and ports. Wireless charging compatible. Limited lifetime warranty. Black.  
**OBX 77-83430** (832503) iPhone 13 Pro Max  
**OBX 77-86358** (832521) Samsung Galaxy S22  
**OBX 77-86361** (832526) Samsung Galaxy S22+



## B Commuter Lite Smart Phone Case

Soft inner and hard outer layers absorb and deflect impacts. Limited lifetime warranty. Black.  
**OBX 77-86911** (832515) Samsung Galaxy A13 5G  
**OBX 77-87675** (832511) Samsung Galaxy A03s

## C Symmetry Smart Phone Case

One-piece design pops on and off your phone in a flash. Limited lifetime warranty. 50% recycled content.  
**Samsung Galaxy S22**  
**OBX 77-86427** (832520) black  
**Samsung Galaxy S22+**  
**OBX 77-86433** (832527) black  
**OBX 77-86507** (832528) clear



## D Armour 2X Smart Phone Case

Military drop test. Slim and lightweight. Precision fit for easy access to all ports. Impact resistant. Black.  
**BEE BEA2XGA13B** (832514) Samsung Galaxy A13 5G  
**BEE 832518** (832518) Samsung Galaxy S22  
**BEE 832524** (832524) Samsung Galaxy S22+

## E DropZone Smart Phone Case

Advanced, ultra-slim impact protection. Bumper cushion around 4 corners offer shockproof protection from the impact of accidental falls or drops. Transparent.  
**BEE 832492** (832492) iPhone 13  
**BEE 832508** (832508) iPhone 13 Pro  
**BEE 832499** (832499) iPhone 13 Pro Max  
**BEE BEDZGA03C** (832510) Samsung Galaxy A03s  
**BEE BEADZGS22C** (832519) Samsung Galaxy S22  
**BEE 832525** (832525) Samsung Galaxy S22+



## F Trusted Glass Screen Protector

Anti-scratch for vivid clarity. Protection from drops, breaks and scratches. Smudge resistant. 100% case compatibility.  
**OBX 77-65608** (832495) iPhone 12/12 Pro  
**OBX 77-85951** (832496) iPhone 13/13 Pro  
**OBX 77-87443** (832513) Samsung Galaxy A03s  
**OBX 77-86790** (832517) Samsung Galaxy A13 5G  
**OBX 77-86353** (832523) Samsung Galaxy S22

## G Tempered Glass Screen Protector

Anti-scratch and resists smudging. Impact protection. Slim and durable.  
**BEE BE3TGA03** (832512) Samsung Galaxy A03s  
**BEE BE3TGA13** (832516) Samsung Galaxy A13 5G



## H 3D Curved Glass Screen Protector

Made to fit displays with larger curvature.  
**BEE BE3DGS22P** (832529) Samsung Galaxy S22+  
**BEE BEA3DGS22** (832522) Samsung Galaxy S22



**A** UAG

**N**  
2023

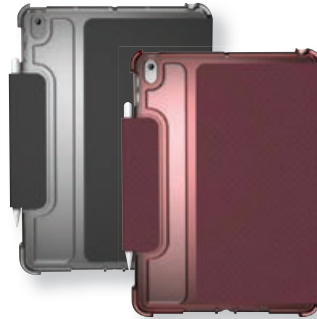

**B** UAG

**N**  
2023

**A Metropolis Rugged Folio Tablet Case**

For iPad 10.2 2021 9th Gen/10.2 2020 8th Gen/iPad 10.2 2019.  
Adjustable stand with auto wake/sleep folio cover. Apple Pencil holder and compatible with Apple Pencil Pairing/Charging.  
Limited lifetime warranty. Cobalt.  
**UAG 832459** (832459) cobalt

**B Lucent Folio Tablet Case**

For iPad 10.2 2021 9th Gen/10.2 2020 8th Gen/iPad 10.2 2019.  
Adjustable stand with auto wake/sleep folio cover. Apple Pencil holder and compatible with Apple Pencil Pairing/Charging. Limited lifetime warranty.  
**UAG 832461** (832461) black  
**UAG 832460** (832460) rose

**C Defender Protective Case**

For iPad 10.2 2021 9th Gen/10.2 2020 8th Gen/iPad 10.2 2019.  
Triple-layer: inner shell, outer cover and touchscreen protector.  
Limited lifetime warranty. Black.  
**OBX 7762032** (832458)



**C** Otterbox

**N**  
2023



**D** Otterbox

**N**  
2023

**D Symmetry Tablet Case**

For iPad 10.2 2021 9th Gen/10.2 2020 8th Gen/iPad 10.2 2019.  
iPad remains stable and secure in both typing and viewing modes.  
Integrated Apple pencil holder for safe storage and convenient access.  
Limited lifetime warranty. Black.  
**OBX 77-62044** (832463)

**E EasyPencil Pro 3**

Palm rejection/ tilt sensitivity. No pairing needed. Quick connection.  
Type-C charging port. No bluetooth required. Simple turn it on with touch switch. Lightweight premium aviation grade aluminum.  
Magnetic attaching. Free extra 1 pc replacement tip. White.  
**SIH 832484** (832484)

**F Chipolo - One Spot Key Finder**

Helps you find missing personal items like keys, luggage or even a child's toy. It works with the Apple Find My network. Simply use the Find My app and locate your items anytime.

**By each**  
**CIP 832473** (832473) black  
**CIP 832468** (832468) blue  
**CIP 832469** (832469) red  
**CIP 832470** (832470) white  
**Package of 4**  
**CIP 832474** (832474) black  
**CIP 832467** (832467) 4 colours

Bluetooth



**E**

**N**  
2023



**F**

**N**  
2023

**G Chipolo - Card Spot Wallet Finder**

Works with the Apple Find My app. When your wallet is hiding nearby, play a very loud sound to locate it. Get a notification when you accidentally leave your wallet behind or when the Apple Find My network locates your missing item.

**CIP 832472** (832472) black  
**CIP 832471** (832471) white

Bluetooth



**G**

**N**  
2023

Find Tablet Portfolio Cases on **page 229**

## A USB-C to USB-C Charging Cable

Works with all USB-C inputs and outputs. Anodized aluminum housing for lasting durability. USB Power Delivery for use up to 5 AMP/100-Watts. Limited lifetime warranty, 6 ft. Black.  
**OBX 78-80212** (832486)



## B USB-A to Lightning Charging Cable

Extra durable, braided design resistant to wear and tear.  
**BEE B4MFIBK** (577924) black (4 ft.)  
**BEE B4MFIWH** (577916) white (4 ft.)  
**BEE B4MFIZB** (577908) zebra (4 ft.)  
**BEE B6MFIBK** (832475) black (6 ft.)  
**BEE B6MFIWH** (832476) white (6 ft.)

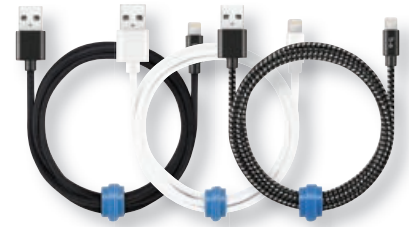

## C USB-A to USB-C Charging Cable

Extra durable, braided design resistant to wear and tear.  
**BEE B4TCBK** (577890) black (4 ft.)  
**BEE B4TCZB** (577882) zebra (4 ft.)  
**BEE B6TCBK** (832480) black (6 ft.)



## D USB-C to USB-C Charging Cable

Extra durable, braided design resistant to wear and tear.  
**BEE BEC2C4B** (832481) black (4 ft.)  
**BEE BEC2C10B** (832482) black (10 ft.)



## E USB-C to Lightning Charging Cable

Extra durable, braided design resistant to wear and tear.  
**BEE BEC2L4W** (832477) white (4 ft.)  
**BEE BEC2CL10B** (832479) black (10 ft.)  
**BEE BEC2CL6W** (832478) white (6 ft.)

## F USB Multi-Charging Cable

This 3ft USB multi-charging cable makes it easy to charge and sync your Apple Lightning or Android devices. USB-A to Micro-USB, USB-C or Lightning cable. Note that it will only connect to one device at a time. 2-year limited warranty. Silver.  
**STC LTCUB1MGR** (832104)



## G Lightning Charge/Synch Cable

Withstands the daily demands of charging and syncing your iPad, iPhone or other mobile devices featuring the Lightning connector. 2-year limited warranty. White.

**USB-A**  
**STC USBLT1MW** (832106) 3 ft.  
**STC USBLT2MW** (832109) 6 ft.  
**USB-C**  
**STC 832107** (832107) 3 ft.  
**STC 832105** (832105) 6 ft.

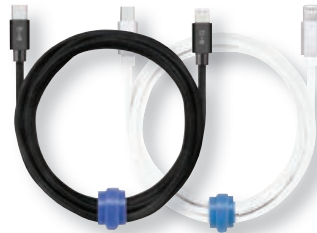

## H Durable White USB-A to Lightning Cable

This 3ft USB-A to Lightning cable withstands the daily demands of charging and syncing your mobile devices. Tested to endure strenuous wear and tear, winter and summer as well as in-car use. The durable Lightning cable has aramid fiber reinforcement that shelters it from the stress of frequent bends and twists. 2-year limited warranty. White.  
**STC RUSBLTMM1M** (832103)





**A Folding Wireless 15W Charging Stand**

Anti-slip, grippy surface holds phone securely at any angle as it charges. Lifetime warranty. Dark grey. **OBX 78-80643** (832455)

**B 2-1 Wireless Charge Stand and Portable Battery**

10W. Can charge through USB-C and USB-A ports when in battery mode. Charger and cable included in the box. 1-year limited warranty. Black. **VNV 832456** (832456)

**C OtterSpot Qi Wireless Charger**

10W wireless charging base powers up to three OtterSpot wireless charging batteries and one device simultaneously. Works with Apple, Samsung, Google and other Qi Wireless enabled phones. 10W wireless charging battery has a USB-C port to recharge without the base. Anti-slip surfaces on top and bottom holds phones in place during charging. Black. **OBX 7852104** (630996)



**D Saffiano Fast Wireless Charger**

Qi 15W with Qualcomm 3.0. 2X Faster charge for iPhone and Android Qi compatible devices. **BEE BWQW15BN** (832457)

**E Qi Universal Wireless Charger**

This 15 W Qi Wireless Charging Stand features advanced charging technology to charge your Qi-compatible mobile devices. The Qi-certified wireless charger delivers up to 15 W, providing the fastest charging speed for your mobile devices. 2-year limited warranty. **STC QWCHSTAND** (832100)

**F Champ 18 W Portable Battery**

USB-A and USB-C ports. Up to 80% charge in 30 min. Charges two devices simultaneously 10,000 mAh battery. 18W. **NMB 832466** (832466)

**G Champ 60 W Portable Battery**

USB-C and USB-A ports. Up to 80% charge in 30 minutes. Charges two devices simultaneously. 20,000 mAh battery. 60W. **NMB 832465** (832465)



## A Wall and Portable Charger

Universal compatibility. Charges up to two devices simultaneously. If used together, the USB-A port is 12W and the USB-C port is 30W. When used alone, USB-C PD port output is 45W and USB-A port output is 30W. Black.

**BEE BEWCCS45WB** (832439)



**A**  blu.element



**B** StarTech.com

## B Versatile Travel Charger

The 17W/3.4A versatile travel charger comes with interchangeable power plugs that let you plug in and charge your devices nearly anywhere around the world. 2-year limited warranty.

**2 USB ports**

**STC USB2PACBK** (832001) black

**STC USB2PACWH** (832002) white

**4 USB ports**

**STC USB4PACBK** (832003) black

**STC USB4PACWH** (832004) white

## C Lightning / USB-C Wall Charging Kit

20W. Lightning 3.3ft. Get up to 58% charge to your smartphone in 30 minutes. Features foldable prongs for a compact design. Limited lifetime warranty.

**OBX 78-80221** (832444) black

**OBX 78-80220** (832443) white



**C** 



**D** 

## D USB-C Wall Charger

Features foldable prongs for a compact design. 30 W.

**OBX 78-80218** (832440) white

**OBX 78-80216** (832441) black

## E Wall Charger with Lightning Cable

12W. Universal compatibility for charging any device.

3.3 ft. cable included. USB-A. White.

**VNV 832445** (832445)

## F USB-C Wall Charger

6 ft. This USB-C wall charger is compatible with USB Type-C devices.

2-year limited warranty. Grey.

**STC WCH1C30** (832095)

## G Wall Charger

Dual USB-C QC 3.0 PD 20W and USB-A 3A wall charger allows you to charge two devices simultaneously.

**BEE BEWCA20WW** (832437) white

**BEE BEWCA20WB** (832438) black



**E**  ventev



**F** StarTech.com



**G**  blu.element



**A** Kensington



**B** Kensington



**A N17 2.0 Laptop Lock**

Made especially for ultra-thin and 2-in-1 laptops. Tested and approved by Dell. Allows for full use of laptop's ports. Won't raise the laptop off its surface and cause it to wobble. Six-Foot (1.8m) carbon steel cable with omnidirectional pivoting head and rotating anchor. 5-year limited warranty. **KMW K60500WW** (831242)

**B Slim N17 Combination Laptop Lock**

Designed for wedge-shaped slots. Carbon steel cable. Resettable 4-digit number code with 10,000 possible combinations. **KMW K68008WW** (831241)

**C Desk Mount Security Anchor Point**

Provides a secure anchor to any work surface. Two one-way security screws and full steel construction prevent cutting. Built-in Kensington security slot. **KMW 64613** (147207)

**D ClickSafe® Combination Laptop Lock**

5 mm cable made from the strongest materials to deliver the highest level of security. Free on-line key and combination code registration for secure key replacement or code retrieval. Kensington security anchor is designed for a secure fit and simple locking. Choose from 10,000 possible combination codes. Attaches to laptop via the Kensington Security Slot found in 99% of computers. 5' length. **KMW 8589664697** (301267)

**E MicroSaver® Locking System**

Galvanized steel cable with lock and adaptor. Installs without screws or tape, by mounting to the security anchor found on most portable computer models. **KMW 64068** (406728)

**F MicroSaver 2.0 Keyed Laptop Lock**

Strong 10 mm lock head offers uncompromised security for even the thinnest laptops and devices. Patented Hidden Pin™ Technology supports anti-pick tubular lock. Carbon steel cable resists cutting attempts and anchors to desk, table or any fixed structure. Pivot and rotate cable. Attaches to the Kensington Security Slot™ found on most laptops. **KMW 65035** (513754)



**C** Kensington



**D** Kensington



**E** Kensington



**F** Kensington

**G Serialized DEFCON® T-Lock Combo Cable Lock**

The lock features a pre-set 4-digit combination lock and is the first laptop computer security product to offer the benefits and convenience of a keyless security solution. Made of 6.5 feet of cut-resistant, galvanized steel cable that loops around any secure object and easily attaches to your laptop computer's lock slot. **TRG PA410S-1** (576561)

**H DEFCON® T-Lock Resettable Cable Lock**

Up to 10,000 possible combinations that can be set or changed at any time. Made of 6.5 feet of cut-resistant, galvanized steel cable that loops around any secure object and easily attaches to your laptop computer's lock slot. **TRG PA410C** (578476)



**G** Targus



**H** Targus



Kensington



## A Cable Lock for Microsoft® Surface™ Pro

Designed for Surface Pro to provide professional-level security and device engagement. Non-invasive locking technology provides easy-to-use security solution that requires no device modifications. Carbon steel cable resists and deters cutting attempts.

**KMW K62055WW** (831243)

## B Slim Portable Combination Lock

Easily transportable and strong, stretching up to 1.8m and shrinking down to 76mm. Plastic sheathing protects surfaces. Allows the laptop to lie flat and stable. Allows for full use of the laptop's ports.

Lets you choose from 10,000 possible combinations. Free online code registration program that allows for quick, secure and easy lookup if the combination is ever lost or forgotten. 5-year limited warranty.

**KMW K60625WW** (831244)

## C Slim NanoSaver® Combination Lock

Allows ultra-thin and 2-in-1 laptops to lie flat and stable. Carbon steel cable resists cutting attempts, and anchors to desks, tables and other attachment points.

**KMW K60603WW** (831245)

## D MicroSaver® 2.0 Keyed Laptop Lock

Made especially for ultra-thin and 2-in-1 laptops. T-Bar locking technology attaches to the Kensington security slot found on most laptops and other devices. Ultra carbon steel cable is extra thick to provide the highest level of cut resistance.

**KMW K64432WW** (831246)

## E Slim Combination Lock

Slim lock head design won't raise your ultra-thin or 2-in-1 laptop off its surface, allowing it to lie flat and stable. Pivot and rotate cable head featuring one-handed operation allows for easy and flexible connection and movement. Resettable 4-wheel Number code with 10,000 possible combinations. Push-button design for one-handed engagement to easily attach lock.

**KMW K60600WW** (831247)

## F Laptop Lock

Fits standard, nano, or wedge-shaped laptop security slots, regardless of brand or generation. Lock tips are easily changed; a tether keeps unused lock tips handy with only one keying system to manage. Smaller key opening helps thwart picking attempts. 5-year limited warranty.

**KMW K62318WW** (831248)

## G Desktop and Peripherals Locking Kit 2.0

The strong lock head is designed for desktop PCs and other devices. 2 adapters and cable trap secure peripheral accessories. Anchor plate allows devices without a Kensington Security Slot to be locked securely. 8-foot carbon steel cable is cut-resistant and anchors to desk, table or any fixed structure.

**KMW K64424WW** (831249)



A



B



C



D



E



F



G



# USB Drives, Reimagined

A new kind of “clean” for USB drives! In an exclusive partnership, Verbatim® and Microban International® are now collaborating to produce high-quality, one-of-a-kind USB drives enhanced with antimicrobial product protection.

## How Does Microban® Technology Work?

Microban® technology works by helping fight the growth of bacteria on a surface. Bacteria, a type of microbe, can lead to an array of problems, including bad odors, product and surface stains, a reduced product lifetime and more.

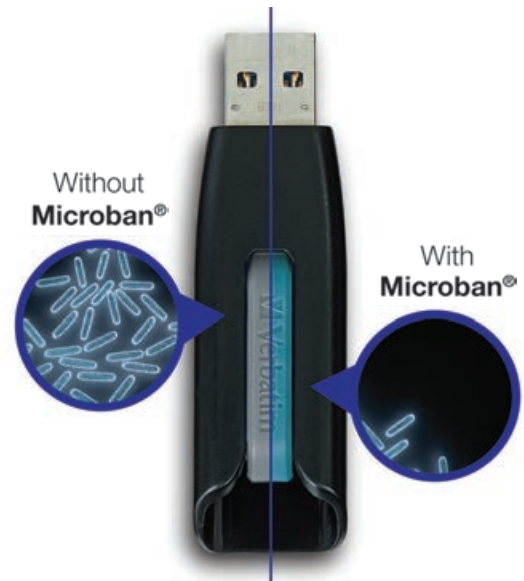

Built-in Microban® antimicrobial product protection helps fight bacteria growth 24/7!

**Microban® technology offers these benefits and more:**



Invisible Protection,  
Visible Cleanliness



USB Stays Cleaner,  
Longer

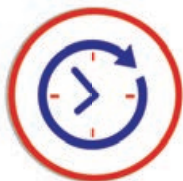

Extended Product  
Lifetime



24/7 Product  
Protection



Won't Wear Off Or  
Wash Away



Effective Against A  
Broad Spectrum Of  
Bacteria

Products available include Verbatim Store N Go V3 & Verbatim Store N Go Classic USB Drives.



Find Verbatim USB drives  
on **pages 43-44**

## A A400 Internal Hard Drive

2.5 in form factor. Solid-state drive dramatically improves the responsiveness of your existing system with incredible boot, loading and transfer times compared to mechanical hard drives. 10x faster than a traditional hard drive for higher performance, ultra-responsive multi-tasking and an overall faster system. Shock- and vibration-resistant for rugged reliability when used in notebooks and other mobile computing devices.

**KIN 587600** (587600) 120 GB  
**KIN 587618** (587618) 240 GB  
**KIN 831311** (831311) 960 GB



**A** **Kingston**



**B** **Verbatim**



## B Vi550 SATA III Internal Solid State Drive

The internal SSD is the ideal option for upgrading hard drive-based PC or laptop computer. Lightning-fast data transfer – up to 560 MB/s read and up to 535 MB/s write\*. Cutting-edge 3D NAND flash technology. Phison controller. 3-year limited warranty.

**VER 49351** (685677) 256 GB  
**VER 49352** (685792) 512 GB  
**VER 70077** (685800) 1 TB

## C Vi560 Internal Solid State Drive

Vi560 SATA III M.2 2280 Internal SSD is an ideal choice for transforming the performance of any hard drive-based laptop or PC. The small M.2 2280 form factor saves space without sacrificing performance, even with limited chassis or motherboard space. Featuring the SATA III interface, the Vi560 Internal SSD boasts transfer speeds of up to 560MB per second read and up to 520MB per second write. With transfer speeds far superior to mechanical hard drives, get ready to experience decreased system boot time, more efficient multitasking and faster system responsiveness.

**VER 70026** (804914) 256 GB  
**VER 70384** (804922) 512 GB



**C** **Verbatim**



## D KC3000 Internal SSD Hard Drive

Uses the latest Gen. 4x4 NVMe controller and 3D TLC NAND, allowing you to upgrade the storage and reliability of your system to keep up with demanding workloads and experience better performance with software applications. With formidable speeds up to 7,000MB/s read/write, it ensures improved workflow.

**KIN 831312** (831312) 512 GB  
**KIN 831313** (831313) 1 TB  
**KIN 831314** (831314) 2 TB  
**KIN 831315** (831315) 4 TB



**D** **Kingston**



## E XS2000 SSD Portable Hard Drive

Industry-leading read/write speeds up to 2,000MB/s. Requires compatible devices to reach USB 3.2 Gen. 2x2 USB-C Performance. Tested to be water resistant, dust resistant and shockproof with an included rubber sleeve. It connects with USB Type-C allowing content creators to access their data anywhere on a PC or mobile device. 5-year limited warranty.

**KIN 831316** (831316) 500 MB  
**KIN 831317** (831317) 1 TB  
**KIN 831318** (831318) 2 TB  
**KIN 831319** (831319) 4 TB



**E** **Kingston**



## F Vx500 SSD Portable Drive

Lightweight, fast, compact and durable, the Vx500 external SSD provides the latest in external data storage options. Transfer rates up to 500 MBps. USB 3.1 Gen 2 connectivity for high-speed data transfer and optimum performance. Ultra-slim form factor is ideal for travel. Shock resistant metal housing withstands everyday bumps and drops. Includes USB-A and USB-C cables.

**VER 47441** (578567) 120 GB  
**VER 47442** (578559) 240 GB  
**VER 47443** (578542) 480 GB



**F** **Verbatim**





**A** SEAGATE



**B** SEAGATE

**A Expansion Desktop Hard Drive**

Instantly add space, consolidate files to a single location, or free up space on your computer's internal drive. Simple drag and drop file saving means no hassle while USB 3.0 connectivity gets the transfer done at blazing-fast speed. Simply plug in the included power supply and USB cable. Drag and drop to save files to the Expansion external hard drive. 1-year limited warranty.

- SGT 831325** (831325) 4 TB
- SGT 831326** (831326) 6 TB
- SGT 831327** (831327) 14 TB
- SGT 831328** (831328) 16 TB
- SGT 831329** (831329) 18 TB

**B FireCuda Gaming HUB Hard Drive**

Customizable RGB LED lighting helps you create the ultimate atmosphere and keeps all your titles safe, sound, and armed right into your battle station. Plus, dual front-facing USB-C and USB-A ports enable you to connect and power all your peripherals in one place. 1-year limited warranty. 8 To.

- SGT 831332** (831332)

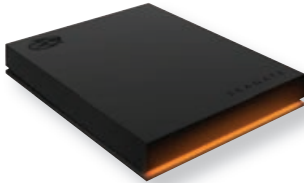

**C** SEAGATE



**D** SEAGATE

**C FireCuda Gaming Hard Drive**

Bring an extra layer of atmosphere to gaming sessions with customizable RGB LED lighting and Razer Chroma RGB compatibility. USB 3.2 Gen. 1 bus-powered for quick function and less clutter, seamlessly play your games at home or at a friend's place. 1-year limited warranty.

- SGT 831330** (831330) 2 TB
- SGT 831331** (831331)

**D FireCuda Gaming SSD Hard Drive**

Portable USB-C drive that accelerates booting, loading, and saving with cutting-edge USB 3.2 Gen 2 x 2 technology, offers space for a massive library of games and levels up your gaming setup with an industrial design highlighted by customizable RGB lights. Speeds of up to 2000MB/s. 5-year limited warranty.

- SGT STJP500400** (831334) 500 GB
- SGT 831335** (831335) 1 TB
- SGT 831336** (831336) 2 TB



**E** Verbatim



**F** SEAGATE

**E Store 'n' Save External Hard Drive**

USB 3.0 is 10 times faster than USB 2.0 standard. Allows full system backup and restore functions. The design allows for vertical or horizontal orientation. Ventilation slots allow for quiet, fanless operation. Sold by each.

- VER 97580** (283499) 2 TB
- VER 97581** (283705) 3 TB
- VER 99399** (557652) 4 TB



**G** SEAGATE

**F Backup Plus Hub External Hard Drive**

6 TB with integrated USB hub. Massive capacity to back up and share your files. Share files between PCs and Macs. Seagate Dashboard software, you are provided with tools for local, mobile, cloud and social media backup. USB 3.0 connectivity.

- SGT 386177** (386177)

**G One Touch SSD Portable Hard Dive**

Small enough for a loaded laptop bag, spacious enough for loads of content. Easily plug into Windows and Mac® computers via USB 3.0, and enjoy helpful tools like customized backup and folder mirroring. Compatible with USB 3.0 and USB 2.0. Black.

- SGT 831320** (831320) 1 TB
- SGT 831321** (831321) 2 TB



**H** SEAGATE

**H One Touch HDD Portable Hard Drive**

Textured metal finish fits in with modern lifestyle elements. Compatible with USB 3.2 Gen. 1 (USB 3.0). 2-year limited warranty.

- 1 TB**
- SGT 590844** (590844) light blue
- 2 TB**
- SGT 593152** (593152) black
- 4 TB**
- SGT 831323** (831323) black
- SGT 831322** (831322) light blue
- SGT 831324** (831324) red

## A Store 'n' Go Secure Pro USB Flash Drive

USB 3.0. Hardware-based 256-bit AES encryption. Anti-tampering features. Retractable connector. Sold by each.  
**VER 98664** (359026) 16 GB  
**VER 98665** (359034) 32 GB  
**VER 98666** (359042) 64 GB

USB 3.0



## B Store 'n' Stay Nano Flash Drive

Plug-in, stay-in drive for notebooks and tablets. Snag-free design for easy transport. Removable for easy file sharing. Always there, always ready flash drive. Password protection. Software; Windows only. USB 3.0.  
**VER 98709** (359059) 16 GB  
**VER 98710** (359067) 32 GB  
**VER 98711** (359075) 64 GB

Password protection | USB 3.0



## C Store 'n' Go USB Flash Drive

Cap-free design with retractable housing. Password protection. Windows only. USB 2.0. Red.  
**VER 96806** (359091) 32 GB  
**VER 97005** (359109) 64 GB  
**VER 98525** (359117) 128 GB



Password protection

Password protection

## D Metal Executive USB Flash Drive

Chip on board technology. Password protection. Software; Windows only. Seamless metal enclosure. Keyring.  
**Silver - USB 2.0**  
**VER 98748** (365049) 16 GB  
**VER 98749** (365056) 32 GB  
**VER 98750** (365064) 64 GB  
**Gold - USB 3.0**  
**VER 99104** (365015) 16 GB  
**VER 99105** (365023) 32 GB  
**VER 99106** (365031) 64 GB



## E DataTraveler 2000 Secure Flash Drive

Designed to be secure, with an alphanumeric keypad that locks the drive with a word or number combination, for easy-to-use PIN protection. Features hardware-based, full-disk AES 256-bit data encryption in XTS mode. FIPS 197 certified, to meet a frequently requested corporate IT requirement. Aluminum housing. USB 3.1 Gen1/6 GB.  
**KIN 437004** (437004)

USB 3.0

## F ToughMax USB 2.0 Flash Drive

Offers the ultimate in data protection. Crush resistant up to 5,000 lb. Water resistant up to 100 ft and temperature resistant from -25 to 150°C. Password protection software available for download.  
**VER 70000** (571547) 16 GB  
**VER 99849** (571588) 32 GB



Password protection

USB 3.0

## G Fingerprint Secure Flash Drive

256-bit AES hardware data encryption. Unlock using just your fingerprint with no password required. Register up to 6 fingerprints. Includes user management application to manage fingerprint access. USB 3.0 performance with USB 2.0 compatibility. Limited lifetime warranty. Silver.  
**VER 70367** (804872) 32 GB  
**VER 70368** (804880) 64 GB  
**VER 70369** (804898) 128 GB





**A**



**B**



**A Store 'n' Go® USB Flash Drive**

Built-in Microban® antimicrobial product protection helps fight bacteria growth. Lifetime limited warranty. Package of 10. 64GB. USB 2.0.  
**VER 70895** (831294)

**B Store 'n' Go® V3 Flash Drive**

Built-in Microban® antimicrobial protection helps fight the growth of bacteria. Limited lifetime warranty. Package of 10. 32 GB. USB 3.2 Gen. 1.  
**VER 70894** (831295)

**C Pinstripe USB Flash Drive**

Push-and-pull sliding mechanism, no separate cap. USB 2.0. Black.  
**VER 49063** (307322) 16 GB  
**VER 49065** (307793) 64 GB  
**VER 49064** (307561) 32 GB

**D Store 'n' Go V3 USB Flash Drive**

USB 3.0. Retractable design, shields USB connector in transit.  
**Black and grey**  
**VER 49172** (307710) 16 GB  
**Black and blue**  
**VER 49176** (307728) 16 GB  
**VER 49173** (307744) 32 GB  
**VER 49174** (307785) 64 GB  
**VER 49189** (337626) 128 GB  
**VER 49168** (359018) 256 GB

USB 3.0



**C**



**D**

**E USB 2.0 Flash Drive**

The retractable housing protects the USB connector and easily slides in and out. 16 GB. Blue.  
**VER 97275** (429761)

**F Store 'n' Go Dual USB 3.0 Flash Drive for Apple Lightning Devices**

Quickly and easily transfer content between your PC and Apple device. Apple certified MFi product, made for Apple devices with Apple Lightning ports. Limited lifetime warranty.  
**VER 49304** (379685) 16 GB  
**VER 49300** (379628) 32 GB  
**VER 49301** (379669) 64 GB

USB 3.0



**E**



**F**

**G Store 'n' Go Dual USB 2.0 Flash Drive for Micro-USB Devices**

Easily transfer or offload files from a Micro-USB compatible device to the Dual USB Flash drive. Easily transfer content between a device and/or PC/Mac without a Wi-Fi connection or using data. Limited lifetime warranty. Black.  
**VER 99140** (429266) 64 GB

USB 3.0 | Type-C



**G**

**H**



**i** Verbatim Store'n'Go USB drives are enhanced with Microban® antimicrobial protection.

## A Pro Memory Card With Adapter

32GB, microSDHC, 600X, UHS-1, Class 10. V30 video speed class - supports 4K video recording.

VER 47041 (831297)



## B MicroSDHC Endurance Memory Cards

For home security, surveillance, body and dash cams. UHS-I Speed Class 1 (U1). Up to 95MB/s read, 30MB/s write. SD adapter not included.

KIN SDCE/32GB (831305) 32 GB

KIN SDCE/64GB (831306) 64 GB



## C MicroSDXC Canvas Go Plus Memory Card

For Android mobile devices, action cams, drones and 4K video production. Up to 170MB/s Read, 90MB/s Write.

KIN 831303 (831303) 128 GB

KIN 831304 (831304) 256 GB



## D Premium Micro SDHC/SDXC Memory Card With Adapter

V10 video speed class - supports Full HD (1080p) recording. UHS-I Interface, U1 speed rated.

VER 44082 (287078) 16 GB SDHC

VER 44083 (287086) 32 GB SDHC

VER 44084 (287219) 64 GB SDXC

VER 44085 (578575) 128 GB SDXC



## E Premium Memory Card

V10 video speed class - supports Full HD (1080p) recording. UHS-I Interface, U1 speed rated. Up to 45MB/s read speed.

VER 96808 (307264) 16 GB SDHC

VER 96871 (307272) 32 GB SDHC

VER 44024 (1068147) 64 GB SDXC

VER 44025 (1068155) 128 GB SDXC



## F Pro UHS-1 Memory Card

Class 10. 90 Mbps read, 45 Mbps write.

VER 98046 (376814) 16 GB SDHC

VER 98047 (376822) 32 GB SDXC

VER 98670 (376848) 64 GB SDXC



## G Universal Card Reader

Compatible with most card formats. Sleek, modern design. Silver.

VER 97705 (1012327) USB 2.0

VER 97706 (287334) USB 3.0



## H SD/Memory Stick Pocket Card Reader USB 2.0

Multi-functional; supports a variety of memory card formats, including SD, Memory Stick and M<sup>MC</sup> interfaces. Integrated USB cable, plug-and-play with both Windows and Mac. 1-year limited warranty.

VER 97709 (287342)



## I USB-C™ Pocket Card Reader

For use with USB-C equipped computers and laptops. Supports a variety of memory card formats with no additional adapter needed. Plug-and-play functionality with both Windows and Mac operating systems.

VER 99236 (831296)



## J USB 3.0 High-Speed Card Reader

Reader reads all major card format types and supports UHS-I and UHS-II SD card speeds. Easy to read built-in LED indicator. 2-year limited warranty. Grey.

KIN FCR-HS4 (831308)



## K MobileLite Plus Card Reader

USB 3.2 Gen.1 bus to natively supports UHS-II microSD/SDHC/SDXC cards, while remaining backward compatible with UHS-I media. USB Type-A. Transfers files quickly. 2-year limited warranty. Black.

KIN MLPM (831309)



## L USB 3.0 Universal Card Reader

Transfers your photos and data 10 times faster than USB 2.0 reader. Compatible with most card formats. USB 3.0 connectivity. Black and red.

VER 98538 (1012319)





**A**



**B**



**C**



**D**



**E**



**F**



**G**



**A External All-in-One Optical Writer**

Compatible with BD-L discs – capacities up to 100GB. Maximum write speeds of 6X for Blu-ray, 8X for DVD and 24X for CD. USB 3.2 Gen. 1 performance with USB 2.0 compatibility. Includes USB Type-C adapter. 1-year limited warranty.  
**VER 71094** (831340)

**B 52x Writable CD-Rom**

700 Mb/80 min.  
**Spindle**  
**VER 94691** (307082) pkg 50  
**Jewel cases**  
**VER 94935** (429852) pkg 10  
**VER 94554** (287284) pkg 100

**C 52x Printable CD-R**

Ink jet printable. On spindle. 700 MB/80 minutes.  
**VER 96189** (331595) pkg 25  
**VER 95005** (370429) pkg 50  
**VER 95252** (1012129) pkg 100

**D 16x Writable DVD-R Disk**

High speed recording. On spindle. 4.7 GB.  
**VER 95101** (359141) pkg 50  
**VER 95137** (370445) pkg 50 (printable)  
**VER 95102** (287318) pkg 100

**E 16x Writable DVD+R Disk**

AZO technology for superior performance and reliability. On spindle. 4.7 GB, 120 minutes.  
**VER 95037** (307231) pkg 50  
**VER 95098** (557769) pkg 100

**F DVD+RW Rewritable Disk**

4x recording. 4.7 GB/120 minutes.  
**VER 94839** (528349) pkg 10 (jewel case)  
**VER 94834** (307777) pkg 30 (spindle)

**G DataLife Plus DVD+R Printable Disk**

White matte surface for ink jet printing. Up to 8x with double layer drive. 8.5 GB.  
**VER 95311** (528372) pkg 5 (jewel case)  
**VER 98319** (307827) pkg 50 (spindle)

**H 4x Rewritable DVD-RW Disk**

Can be rewritten up to 1000 times. Slim case. 4.7 Go/120 minutes. Sold by each.  
**VER 94836** (358705)



**H**



## A LTO-7 Ultrium RW Data Cartridge

This media is rewritable and to help keep your data secure, features FIPS 140-2 Level 1 and AES 256-bit encryption. Archival life of up to 30 years. Limited lifetime warranty.

- HEW C7977A (831337) 15 TB
- HEW Q2078A (831338) 30 TB
- HEW Q2079A (831339) 45 TB



## B CD/DVD Slim Jewel Cases

Package of 50. Assorted colours.  
VER 94178 (283457)

## C Flexible Slim CD/DVD Case

Break resistant durable plastic. Package of 50 cases individually poly bagged. Clear.  
DTA 02154 (728600)

## D CD Window Envelopes

Open side. Ungummed flap. 4-7/8 x 5 in. 24 lb. White woven. FSC® certified.  
SPX 0019876 (337618) pkg 25  
SPX 338442 (338442) box 1000

## E CD / DVD Paper Sleeves With Clear Window

Envelope-style closure. Protects from scratches, dust, and light exposure. Package of 100.  
VER 49976 (385740)

## F USB Flash Drive

Vinyl. Package of 6. Clear.  
GMX 1USBA-6 (601880)

## G Adhesive CD/DVD Pockets

Vinyl. Package of 10. Clear.  
GMX 1DVDA-10 (601898)





# THE PERFECT COMBINATION

Improve productivity and security at your workspace with one of these top-of-the-line combos



## Signature MK650 Combo for Business

This signature combination delivers all-day comfort while improving workflow and increasing productivity.

Logitech Part #:  
920-010909 (English)  
920-011403 (French)



## MK850 Wireless Performance Combo

Experience next-level comfort and productivity thanks to this combo's cushioned palm rest, curved keyframe, and contoured mouse.

Logitech Part #:  
920-008219 (English)  
920-008220 (French)



## MK550 Wireless Wave Combo

Get the ergonomic benefits of a cushioned palm rest and wave-shaped keyframe from the K350 Wave keyboard and the wireless freedom of the M510 mouse.

Logitech Part #:  
920-002555 (English)  
920-002808 (French)



## MK540 Advanced Wireless Combo

This instantly familiar wireless keyboard and mouse combo is built for precision, comfort, and reliability.

Logitech Part #:  
920-008671 (English)  
920-008672 (French)



For more information go to [logitech.com/business](https://www.logitech.com/business)

© 2022 Logitech. All rights reserved. Logitech, the Logitech logo and other Logitech marks are owned by Logitech and may be registered. All other trademarks are the property of their respective owners. Logitech assumes no responsibility for any errors that may appear in this publication. Product, pricing and feature information contained herein is subject to change without notice.

logitech®



**A K750 Wireless Solar Keyboard**

Solar-powered keyboard charges itself whenever there's light and stay charged for at least three months in total darkness. Fluid and whisper-quiet keys. Sleek lines and thin profile. 2.4 GHz wireless. USB unifying receiver. English.  
**LOG 920-002912** (358945)



A



B



**B Wave MK550 Wireless Keyboard/Mouse Combo**

Wave-shaped key frame. Cushioned, contoured palm rest. Advanced 2.4 GHz technology. Unifying USB receiver.  
**LOG 920-002555** (355123) Bilingual  
**LOG 920-002808** (157958) French

**C MK540 Wireless Keyboard / Mouse Desktop**

Palm rest and adjustable tilt legs. Contoured and ambidextrous mouse. 3 x AA alkaline batteries (pre-installed).  
**LOG 920-008671** (571471) English  
**LOG 920-008672** (571489) French



C



D

**D K400 Plus Wireless Touch Keyboard**

HTPC keyboard for PC connected televisions. Quiet, comfortable keys and large 3.5 in touchpad. Wireless range of up to 10 meters. Shortcuts for Windows® and Android™ users. 2 x AA batteries, (pre-installed). 2.4 GHz.  
**LOG 920-007119** (576546)

**E K360 Wireless Keyboard**

Size is 20% smaller than standard keyboard. 6 hot keys for media functions. Twelve programmable F-keys. 2.4 GHz wireless technology. USB unifying receiver to connect up to 6 devices. Whisper-quiet keys.  
**LOG 920004088** (197632) English  
**LOG 920-004090** (197640) French

**F MK320 Wireless Keyboard/Mouse Combo**

2.4 GHz wireless technology. 32-foot range. Full-size standard keyboard with shortcut keys. USB. 1 combo set. Black.  
**LOG 920-002836** (353128) English  
**LOG 920-002840** (156281) French

E

F

**G MK270 Wireless Keyboard/Mouse Combo**

Long-range wireless. Carry-around mouse with nano-receiver and scroll wheel. Spill-resistant keyboard with keypad and nine F keys. Eight hot keys. USB. English.  
**LOG 920-004536** (255497)



**H MK120 Keyboard/Mouse Combo**

Low-profile keys offers quiet typing. Full-size F keys. Spill-resistant design. Adjustable tilt legs. Optical mouse with high-definition tracking and scroll wheel. USB. English. 1 set. Black.  
**LOG 920-002565** (205153)



G



H



**A**



**B**



**C**



**D**



**E**



**F**



**G**



**H**



**I**

**A Sculpt Ergo Wireless Keyboard/Mouse Combo**

Tri-dimensional design promotes natural wrist position. Split spacebar with backspace functionality. Split keypad. Cushioned palm rest. Mouse features a blue Windows touch tab, right-handed scoop design and four-way scrolling with tilted wheel. USB. 1 combo set. Black.  
**MSF L5V-00002** (255323) English  
**MSF L5V-00003** (255331) French

**B Sculpt Comfort Wireless Keyboard/Mouse Combo**

Contoured design promotes natural wrist position. Split spacebar with backspace functionality. Cushioned palm rest. Mouse features a blue Windows touch tab, right-handed scoop design and four-way scrolling. USB. 1 combo set. Black.  
**MSF L3V-00002** (255273) English  
**MSF L3V-00003** (255315) French

**C Wireless Comfort Desktop 5050 Keyboard and Mouse**

Encourages you to use a more natural posture. Built in palm rest helps support and straighten wrists. Ambidextrous mouse with two buttons and scroll wheel. 4 AA batteries included.  
**MSF PP4-00002** (579466) English  
**MSF PP4-00003** (579474) French

**D All-in-One Media Wireless Keyboard**

With full-size keyset and integrated multi-touch trackpad. Customizable media hot keys. Easy access volume controls. Durable spill-resistant design. Works with select TVs and gaming consoles. USB. Sold by each.  
**MSF N9Z-00002** (283929) English  
**MSF N9Z-00003** (283937) French

**E 2000 Wireless Keyboard/Mouse Combo**

Features AES encryption standard which can help protect your personal and business information by encrypting what you type. Easy access hot keys. Pillow-textured palm rest. Windows Start button. Bluetooth wireless mouse offers 4-way scrolling. USB. 1 combo set. Black.  
**MSF M7J-00002** (197392) English  
**MSF M7J-00003** (197400) French

**F 850 Keyboard and Mouse Wireless Combo**

Roam up to 15 feet away from your PC. Or, take the mouse separately to use with a laptop while traveling. Plug and play. 3-year limited warranty.  
**MSF PN9-00003** (832619) English  
**MSF PN9-00002** (832618) French

**G 3050 Wireless Keyboard/Mouse Combo**

Features AES encryption standard which can help protect your personal and business information by encrypting what you type. BlueTrack technology. Windows shortcut keys. Snap-in mini-transceiver stows under the mouse. USB. 1 combo set. Black.  
**MSF PP3-00002** (355065) English  
**MSF PP3-00003** (355073) French

**H Wireless Business Keyboard and Mouse Combo**

Pairs seamlessly with your laptop via Bluetooth and delivers extra-long battery life. Built-in Shipping key to capture what you need quickly and efficiently. 3-year limited warranty.  
**MSF 1AI-00001** (832620) English  
**MSF 1AI-00002** (832621) French

**I 850 Wireless Keyboard/Mouse Combo**

2.4 GHz wireless technology. Features AES encryption standard which can help protect your personal and business information by encrypting what you type. Windows shortcut keys. Snap-in transceiver stows under the mouse. Precise optical tracking technology. Windows Start button. Battery life indicator. USB. 1 combo set. Black.  
**MSF PY9-00002** (355081) English  
**MSF PY9-00003** (355099) French

**A Silent Wireless Compact Keyboard and Mouse**

Truly silent mouse and keyboard featuring silent key design and silent click switches. 1-year limited warranty. English.  
**VER 70739** (832617)



**B Wireless Multimedia Keyboard and 6-Button Mouse Combo**

Compatible with Windows and Mac platforms. 1-year limited warranty. English.  
**VER 99788** (832616)

**C Wireless Silent Mouse and Keyboard**

Silent click Technology and rubber covers. 2.4 GHz wireless connection. Blue LED technology allows for use on virtually any surface. Slim keyboard features full numeric keypad and full-size function keys. Plug-and-forget nano receiver connects mouse and keyboard to computer. Mac and Windows. English keyboard. 1 set. Black.  
**VER 99779** (571521)

**A**

**B**

**D Wireless Keyboard 850**

Features Advanced Encryption Standard (AES) 128 bits. Wireless connection 2.4 GHz. Windows shortcut keys. Media keys for music and video control. Battery status indicator. Powered by 2 x AAA. USB.  
**MSF PZ3-00002** (370627) English  
**MSF PZ3-00003** (370635) French



**E Ergonomic Wired Keyboard**

QWERTY. Work in comfort all day. Reduces fatigue and delivers a slim, refined design with split keyboard, improved cushioned palm rest, and dedicated shortcut keys. USB connection.  
**MSF LXN-00001** (804112) English  
**MSF LXN-00002** (804104) French

**F 600 Wired Microsoft Keyboard**

Quiet, responsive, thin-profile keys. 4 media hot keys. Spill-resistant design. Plug and Play set up. USB.  
**MSF ANB-00002** (127647) English  
**MSF ANB-00003** (110064) French

**C**

**D**

**G K120 Wired Keyboard**

Slim profile with quiet, ultra-flat keys. Standard configuration with full-size function keys and numeric keypad. Splash proof design. Adjustable tilt legs. USB. English.  
**LOG 920-002478** (205096) English  
**LOG 920-002851** (205104) French



**H Slimline Corded Keyboard**

Advanced tactile keys with low-profile design for quiet, comfortable typing. Numeric keypad and full-size function keys. Simple, plug and play USB corded connection. Compatible with Windows and Mac. English.  
**VER 99201** (546101)

**E**

**F**



**G**

**H**

# Kensington®

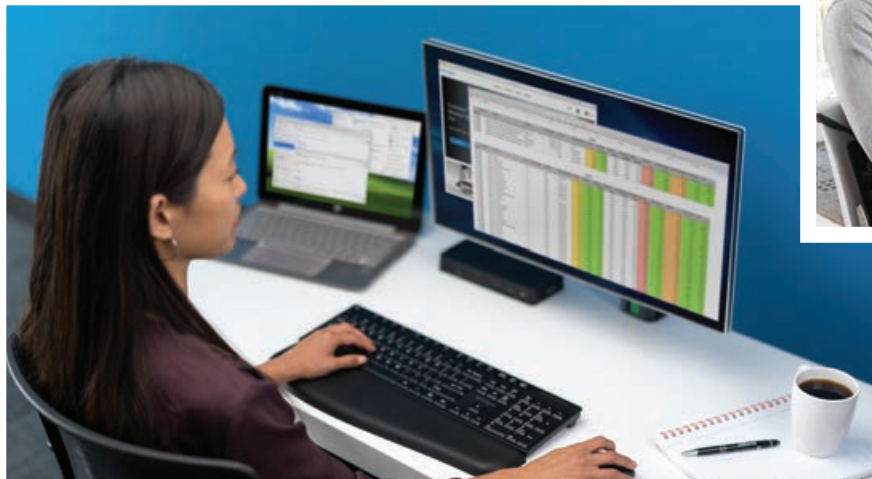

## Fit for Work, Fit for Life

Design a workspace to fit in with you and reach new levels of wellness, whatever way you work.

At Kensington, we have the opportunity to offer solutions across a number of categories, in a way that allows customers to immediately understand the benefits of achieving employees' optimal wellbeing while working no matter where the office is.



SoleSaver™ Footrest  
740-8589656152



Pro Fit® Wireless Keyboard  
740-8589672450



Pro Fit® Mid-Size Wireless Mouse  
740-8589672370 — Black  
740-8589672421 — Sapphire Blue  
740-8589672422 — Ruby  
740-8589672423 — Graphite Gray

**A MX Vertical Wireless Mouse**

Designed to reduce muscle strain, decrease wrist pressure, and improve posture. Reduces muscular strain by 10 percent and promotes a more ergonomic posture. It's unique 57° vertical angle reduces the pressure on your wrist. 1-year limited warranty. Grey.

LOG 910-005447 (832631)



**B ERGO M575 Ergonomic Wireless Mouse**

With an easy thumb control, this wireless trackball mouse is engineered to reduce hand movement, keeping the hand and arm relaxed and providing hours of comfort. Uses a microUSB receiver. 2-year limited warranty. Black.

LOG 910-006197 (832630)



**C Evoluent 4 Ergonomic Vertical Mouse**

Patented shape supports your hand in an upright neutral posture that helps avoid forearm twisting. Design and easy-to-reach, programmable buttons. Adjustable speed with speed indicators. 2.4 GHz optical technology with USB receiver.

Standard size wired - grey

ELU VM4R (283523) right-handed

ELU VM4L (283531) left-handed

Small size wired - black/purple

ELU VM4S (357913) right-handed

Standard size wireless - black/blue

ELU VM4RW (283549) right-handed, black/blue

Small size wireless - black/brown

ELU VM4SW (423921) right-handed

**A** logitech



**B** logitech



**D Basic Wired Optical Mouse**

Optical technology for smooth, precise control. Features a symmetrical, comfortable design for both right-handed and left-handed users. 3-year limited warranty. White.

MSF P58-00064 (832555)



**E Silent Wired Mouse**

Silent clicks, and rubber covers. High-resolution optical technology for smooth and precise tracking. Compatible with Mac and Windows platforms. 1-year limited warranty.

VER 99790 (832556) black

VER 70235 (832559) purple

VER 70233 (832557) blue

VER 70234 (832558) red

**C** Evoluent



**D** Microsoft



**F Comfort Mouse 4500 Wired Mouse**

With rubber side grips and five programmable buttons. Fits either hand. BlueTrack technology allows the mouse to be used on virtually any surface. Scroll wheel. USB. Black.

MSF 4FD-00026 (219055)



**G Basic Wired Optical Mouse**

Optical technology. Scroll wheel. Programmable buttons for quick access to the media, programs and files you use most often. Comfortable in either hand. USB. Black.

MSF P58-00063 (244103)

**E** Verbatim



**F** Microsoft



**H M100 Wired Mouse**

Standard size for left- or right-handers. 1000 dpi optical tracking. Scroll wheel. USB. Black.

LOG 910-001601 (363754)



**I Notebook Wired Optical Mouse**

Comfortable ergonomic design. High-resolution optical technology. Compatible with PC and Mac. USB.

VER 99742 (520072) red

VER 99743 (520056) blue



**G** Microsoft



**H** logitech



**I** Verbatim



 <p><b>A</b>  <b>Verbatim</b></p> <p><b>N</b> 2023 </p>	 <p><b>B</b>  <b>Verbatim</b></p> <p></p>	<p><b>A USB-C Wireless Blue LED Mouse</b> Adjustable DPI button – easily switch between 800, 1300 and 1600 DPI. Blue LED technology allows for use on virtually any surface with precision and control. 1-year limited warranty. <b>VER 70245</b> (832627) graphite <b>VER 70246</b> (832628) red <b>VER 70247</b> (832629) teal</p> <p><b>B Wireless 6-Button Deluxe Mouse</b> BlueTrack LED technology works on virtually any surface. Multi-button functionality enables users to navigate within and between applications with ease. Left-right, back/forward buttons and scroll wheel. Windows 8 home button. Requires 1 AA battery (included). USB. <b>VER 98621</b> (359190) graphite <b>VER 99016</b> (359208) blue <b>VER 99017</b> (359216) purple <b>VER 99018</b> (359224) red</p>
 <p><b>C</b>  <b>Verbatim</b></p> <p></p>	 <p><b>D</b>  <b>Verbatim</b></p> <p></p>	<p><b>C Wireless 8-Button Deluxe Mouse</b> BlueTrack LED technology works on virtually any surface. Multi-button functionality enables users to navigate within and between applications with ease. Left-right, back/forward buttons and scroll wheel. DPI button controls mouse sensitivity (800, 1200, 1600) Windows 8 home button. Zoom. USB. <b>VER 98622</b> (359232) graphite <b>VER 99019</b> (359240) blue <b>VER 99020</b> (359257) purple <b>VER 99021</b> (359265) red</p> <p><b>D Bluetooth® Wireless MultiTrac Mouse</b> Simply pair your mouse to your device using Bluetooth technology, no receiver needed. Blue LED offer precise mousing on virtually any surface. Ambidextrous contour shape with grips. Requires 1 AAA battery (included). Black. <b>VER 98590</b> (365106)</p>
 <p><b>E</b>  <b>Verbatim</b></p> <p></p>	 <p><b>F</b>  <b>Verbatim</b></p> <p></p>	<p><b>E Wireless Notebook Optical Mouse</b> 2.4 GHz wireless technology. Contoured design for right or left hand use. <b>VER 99765</b> (520015) black <b>VER 99766</b> (520031) blue <b>VER 99767</b> (1013069) red <b>VER 99768</b> (520023) white</p> <p><b>F Multi-Trac Wireless Optical Mouse</b> LED technology allows to navigate anywhere, on virtually any surface with precision and control. Ergonomic shape. Scroll wheel. USB nano receiver. Requires 1 AA battery (included). <b>VER 97992</b> (307835) black <b>VER 97993</b> (307843) blue <b>VER 97994</b> (307850) violet <b>VER 97995</b> (307868) red</p>
 <p><b>G</b>  <b>Verbatim</b></p> <p></p>	 <p><b>H</b>  <b>Verbatim</b></p> <p></p>	<p><b>G Silent Wireless Mouse</b> Truly silent mouse featuring Silent click Technology and rubber covers. 2.4 GHz wireless connection. Blue LED technology allows for use on virtually any surface with precision and control. Ergonomic design and comfort grip for ease-of-use. Plug-and-forget nano receiver connects mouse to computer. Compatible with Mac and Windows platforms. USB. <b>VER 99769</b> (571570) graphite <b>VER 99770</b> (571539) blue</p> <p><b>H Mini Travel Wireless Mouse</b> Ultra-portable design is great for storing in a briefcase for use on the road. Nano wireless receiver. Scroll wheel. 2.4 GHz wireless reliability. Requires 1 AAA battery (included). USB. <b>VER 97470</b> (340489) graphite <b>VER 97471</b> (557678) blue <b>VER 97540</b> (331769) red</p>
 <p><b>I</b>  <b>logitech</b></p> <p></p>	 <p><b>J</b>  <b>logitech</b></p> <p></p>	<p><b>I M317 Wireless Optical Mouse</b> Advanced 2.4 GHz wireless technology. 2-button ambidextrous design with scroll wheel. USB nano receiver. Rubber grips. Requires 1 AA battery (included). Black. <b>LOG 910-003416</b> (263939)</p> <p><b>I M510 Wireless Laser Mouse</b> Full-size, contoured ambidextrous design with soft rubber grips 2.4 GHz wireless technology. Unifying micro-receiver allows to connect up to 6 compatible mice and keyboards. Smooth and responsive laser tracking. 2-year battery life. Programmable buttons. Requires 2 AA batteries (included). USB. Black. <b>LOG 910-001822</b> (352153)</p>



**A Sculpt Ergo Wireless Mouse**

Optical BlueTrack technology works on virtually any surface. Right-handed thumb scoop design. Four-way scrolling with tilted wheel. Requires 2 AA batteries (included). USB. Black. **MSF L6V-00002** (255257)



**A** Microsoft



**B Sculpt Comfort Wireless Mouse**

Optical BlueTrack technology works on virtually any surface. Right-handed thumb scoop design. Four-way scrolling. Requires 2 AA batteries (included). Bluetooth. Black. **MSF H3S-00004** (255240)



**B** Microsoft



**C Bluetooth® Ergonomic Mouse**

Features a soft, ergonomic thumb rest, detent scrolling and two programmable buttons. Ergonomic design promotes neutral hand position. Holds a charge for up to 15 months. 1-year limited warranty. Black. **MSF 22B-00001** (832624)



**C** Microsoft



**D Bluetooth® Mouse**

Features a modern, compact design that fits comfortably in your hand. Works on most surfaces. Connect via Bluetooth 5.0 LE and Swift Pair. Requires 1 AA battery (included). 1-year limited warranty. Black. **MSF RJR-00001** (832625)



**D** Microsoft



**E Wireless Mobile Mouse 1850**

Built-in transceiver storage. Comfortable to use with either hand and a scroll wheel for easy navigation. 2.4 GHz. Operational Range up to 15'. USB nano transceiver. 1-year limited warranty. Black. **MSF 7MM-00001** (832626)



**E** Microsoft



**F 1850 Mobile Wireless Mouse**

Compact wireless mouse with built-in transceiver storage. Scroll wheel. Ambidextrous shape. Requires 1 AA battery (included). USB. S **MSF U7Z-00002** (277855) black **MSF U7Z-00012** (277889) wool blue **MSF U7Z-00032** (277871) flame red **MSF U7Z-00022** (277863) light orchid **MSF U7Z-00042** (277905) purple



**F** Microsoft



**G ERGO M575 Ergonomic Wireless Mouse**

Easy thumb control. Wireless trackball mouse engineered to reduce hand movement keeps the hand and arm relaxed and provides hours of comfort. MicroUSB receiver. 2-year limited warranty. Black. **LOG 910-006346** (832632)



**G** Microsoft



**H M325 Wireless Mouse**

Optimal mix of micro-precision and comfort with design-for-web scrolling. Contoured shape with textured rubber grips. Unifying receiver connects up to 6 devices. 2.4 GHz advanced technology offers laser grade tracking. Requires 1 AA battery (included). USB. **LOG 910-002332** (362293) silver **LOG 910-002136** (363663) dark silver **LOG 910-002650** (352781) blue **LOG 910-002974** (357954) black



**H** Microsoft



**I M185 Wireless Mouse**

For notebook. Simple, reliable, plug-and-play 2.4 GHz wireless mouse. Nano-receiver. On/off switch helps preserve battery life. Comfortable contoured shape. Requires 1 AA battery (included). USB. Black. **LOG 910-002225** (362780)



**I** logitech



**J M310 Wireless Notebook Mouse**

Full-size, contoured design with soft rubber grips. Plug-and-play. 2.4 GHz wireless technology with micro-receiver. Smooth, responsive cursor tracking. 12-month battery life. Scroll wheel. USB. Silver. **LOG 910-001675** (352849)



**J** logitech



**I** logitech



**J** logitech



Antimicrobial protection

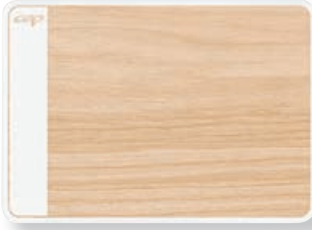

**A Silva Mouse Pad**

100% phthalate-free PVC. Antiglare flap accepts picture or other document. Anti-slip base. White/beech.  
**GRN CEP810** (832988)

**B Ultra Thin Optical Mouse Pad**

Superior tracking for optical and laser mice. Great for storing in notebook. Non-skid backing. Antimicrobial protection. 9 x 7 x 1/32 in. H. Black.  
**FEL 5908101** (121004)

**C Microban® Mouse Pad**

Provides superior tracking with both ball and optical mice. Skid-free natural rubber. Antimicrobial protection.  
**FEL 5933801** (189639) blue  
**FEL5933901** (712745) black

**D Mouse Pad**

Flexible high density foam, PVC free. Slightly textured surface.  
**EXM 52102** (200147) blue  
**EXM 52101** (183640) grey

**E Mouse Pad**

Precise surface enhances the precision of optical mice at fast speeds. Battery saving design extends battery life of wireless mice up to 50%. Foam mouse pad with non-skid backing keeps mouse pad in place. 9 x 8 in. Grey.  
**MMM MP114BSD1** (358549)

**F Precise Recycled Mouse Pad**

Non-skid rubber base made from 95% post-consumer recycled tires. Durable, easy to clean surface. 9 x 7-1/2 x 1-1/16 in.  
**FEL 5916201** (433839) sunrise  
**FEL 5903901** (784413) ocean

**G Thin Mouse Pad**

Surface designed to enhance precision of optical mice. Repositionable adhesive back. Extends battery life of wireless mice up to 75%.  
**MMM MP200PS** (768838)



Antimicrobial protection

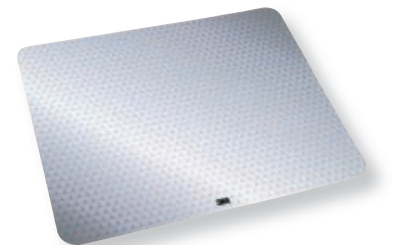

## A PlushTouch™ Mouse Pad/Wrist Rest

FoamFusion technology for superior comfort. Microban anti-microbial protection. Optical/laser-friendly mouse pad. Non-skid backing. Black.  
**FEL 9252002** (189555) regular  
**FEL 9297401** (275891) thin



**A** **Felloges**

## B Premium Gel Mouse Pad/Wrist Rest

Gel filled with polyester covering. Height and angle adjustable. 2 flat positions with a 10 mm forward or negative tilt adjustment. Precision tracking surface. Graphite.  
**FEL 9374001** (283382)



**B** **Felloges**

## C Super-Gel Mouse Pad With Wrist Rest

Gel-filled wrist rest. Contoured shape.  
**DTA 02086** (228791) grey  
**DTA 02121** (228809) blue



**C** **DAC ERGONOMICS**

## D MP-127 Super-Gel Mouse Pad With Wrist Rest

Wrist rest cushioned with dense gel. Covered with non-abrasive Lycra. Non-slip base. Rounded shape. 9 x 7-3/4 in. Blue.  
**DTA 02123** (314757)



**D** **DAC ERGONOMICS**

## E Precise™ Mouse Pad With Gel Wrist Rest

Enhances the precision of optical mice at fast speeds enabling optimal performance. Battery saving design extends battery life of wireless mice up to 50%. Wrist rests is filled with gel. 8.5 x 9 in.  
**MMM MW85B** (432542)



**E** **3M**

## F Professional Series Mouse Pad/Wrist Rest

Patented channel relieves wrist pressure to help prevent carpal tunnel syndrome. Memory foam support conforms your wrist for personalized comfort. Optical/laser-friendly mousing surface. Antimicrobial protection. Black.  
**FEL 9181201** (784504)



**F** **Felloges**

## G Gel Wrist Rest/Mouse Pad

Gel-filled wrist rest with leatherette covering. Precise mousing surface. Grey/black.  
**MMM MW309LE** (463042) standard  
**MMM MW310LE** (768853) large



## H Mouse Pad with Gel Wrist Rest

Non-skid base.  
**EXM 56404** (499863) blue  
**EXM 56406** (499871) black



**H** **EX2ONENT**

## I Gel Wrist Mouse Pad

Polyurethane non-slip base with silicone gel wrist rest and polyester fabric. Black.  
**IKW EINTG160MP** (829413) rounded  
**IKW EINTG180MP** (829414) square

**I** **IntekView**



**G** **3M**

Antimicrobial protection



Antimicrobial protection



**A 3M**



Antimicrobial protection



**B 3M**



**A Tilt-Adjustable Platform**

Gel filled and lined with mock-leather. Antimicrobial protection inhibits the growth of micro-organisms. Precise mousing surface extends battery life. Keeps keyboard and mouse close for an improved comfort. Black/metallic grey. 15% recycled content. **MMM WR422LE** (699330)

**B Tilt-Adjustable Platform**

Gel filled wrist rest with a leatherette covering. Antimicrobial protection inhibits the growth of micro-organisms. Black/metallic grey. 15% recycled content. **MMM WR420LE** (699322)

**C WR Series Ergonomic Wrist Rest**

Thin profile for ergonomic keyboards. Soothing gel comfort with soft leatherette cover. Antimicrobial protection inhibits the growth of micro-organisms. Black. 25% recycled content.

**WR340. Extra-long for mouse and keyboard. 25 in. MMM WR340LE** (145995)

**WR315. For curvy keyboards. MMM WR310LE** (228908)

Antimicrobial protection



**C 3M**



**D 3M**

**D Gel Wrist Rest**

Offers support and comfort while you work. Sleek profile uses minimal desk space and is easy to pick up and move around. Wrist rest is filled with gel. 19 x 2 in. Black. **MMM WR85B** (432682)

**E Premium Gel Adjustable Wrist Rest**

Gel filled with polyester covering. Height and angle adjustable. 2 flat positions with a 10 mm forward or negative tilt adjustment. Relieves wrist pressure to help prevent carpal tunnel syndrome. 48 x 9 cm. Graphite. **FEL 9374201** (283408)

**F PlushTouch™ Wrist Rest**

FoamFusion technology for superior comfort. Microban anti-microbial protection. Non-skid backing. **FEL 9297501** (275909) black

Antimicrobial protection



**E Fellowes**



**F Fellowes**

**G MP-124 Gel Wrist Rest**

Contour shape. Gel-filled. Covered with soft fabric. Latex free. Blue. **DTA 02122** (228817)

**H Super Gel Wrist Rest**

Straight edge. Gel-filled and covered with Lycra soft fabric. Non-slip base. 18 x 2.5 x 0.75 in. Blue. **DTA 02124** (145870)

**I Soft Gel Wrist Rest**

Curved edge. Gel filled and covered with a soft fabric, durable and stain-resistant. Non-skid rubber backing. Black. **CCS 23719** (1012707)



**G DAC ERGONOMICS**



**H DAC ERGONOMICS**



**I COMPUCESSORY**

## A AKT180LE Keyboard Tray

Underdesk installation. Includes a highly-adjustable platform that has left and right lateral adjustments. Articulated mousing platform adjusts up, down, left, right, forward and back and tilts forward and back. The Precise™ mousing surface can mount left or right. The adjustable arm raises up to 10 inches above mounting surface for sitting or standing posture for optimal ergonomic benefit. 25% recycled content.

**MMM AKT180LE** (237313)

## B Jive Adjustable Keyboard Drawer

Steel 26 in. platform. Frame swivels to 360°. Adjustable height Lift n' Lock™ at 6.6 in. and negative or positive Dial Tilt tilt.

Gel 26 in. wrist rests. 26 x 11.5 in. Black.

**HZN JV-01** (754705)

## C Easy Adjust Keyboard Tray With Standard Platform

Height adjustments are made in seconds simply by touch. Height and tilt indicators help you achieve perfect settings for comfort. Leatherette gel wrist rest with anti-microbial protection. Includes the 3M™ Precise™ mousing surface which can extend the life of wireless mouse up to 50%.

Height adjusts + 4 / - 6 in. Sold by each. 70% recycled content.

**MMM AKT90LE** (1012681)

## D Modular Keyboard Platform With SmartFit®

Quick custom adjustment according to SmartFit colour guidelines. Independent height and tilt adjustments. Keyboard arm slides under desk when not in use. Built-in wrist rest. 21 x 11 x 6.1 in. H.

3-year warranty.

**KMW 60718** (769521)

## E Designer Suites™ Compact Keyboard Drawer

Fully adjustable tray enhances comfort in smaller workspaces. Warning track keeps the mouse from sliding. Loosen single knob to adjust tray height and tilt. Accommodates both right and left-handed mousing. Fabric memory foam wrist support. Microban® antimicrobial protection.

Black.

**FEL 8017801** (189464)

## F DeskReady® Keyboard Drawer

Offers 3 height positions below desktop (2-3/16, 3-3/16 and 3-1/2 in.). Tray tilts at 3, 6, and 9° to suit personal preference. Separate keyboard and mouse platforms allow you to position mouse on right or left side of keyboard tray. No tools required. Smoothing memory foam for wrist support with antimicrobial protection.

28-3/8 x 14 x 3-1/2 in. H (Dimensions refer to keyboard stand excluding clips).

**FEL 8038302** (283325)



**A 3M**



**B HORIZON**



**C 3M**

**D Kensington**

Find Keyboards on **pages 49-51**



**E Fellowes**

**F Fellowes**



**A** IntekView®

**A Clamp-On Keyboard Tray**

Height adjustable up to 3.2 in. Locking mechanism. Slides away under desk when not in use. Cable management included.  
26.4 x 9.4" in. Black.  
**IKW KT1040** (833108)



**B Underdesk Comfort Keyboard Drawer With SmartFit®**

26 in. tray with integrated mousing area. Fits all sizes of keyboards. 4-positions height adjustable. Includes of full-length gel wrist rest and mouse pad. SmartFit™ personalized adjustment. 26 x 13-5/8 x 2-3/4 in.  
**KMW 60004** (611012)



**B** Kensington®

**C Keyboard Drawer**

Laminated. With 3 mil PVC edge. Underdesk installation. Gel wrist rest (optional). 28 x 11-3/4 in.  
**HZN KL28S** (121053)

**D Keyboard Drawer With Wrist Rest**

3-positions adjustable heights. Mouse tray mounts on both sides of the keyboard. Memory foam wrist rest with antimicrobial protection. 30-7/8 x 14-1/16 x 2-1/2 in. H. Black/silver. 100% recycled content, 18% post-consumer.  
**FEL 8031201** (715250)



**C** HORIZON

**E Keyboard Drawer**

Underdesk installation. 3-positions heights adjustments. Retractable mouse tray can be installed on the right or on the left. Keyboard stopper. 100% recycled content, 18% post-consumer waste. 22 x 11-5/8" x 2-5/16 in. H.  
**FEL 9140301** (727420)

**F Keyboard Drawer**

Ball bearing assisted slide rails. Compartments for accessories. 22 x 16 x 2-1/2 in. Black.  
**EXM 56316** (751313)



**D** Fellowes



**E** Fellowes



**F** EX2ONENT

## A DH630/640 In-Line Copy Holder

Keeps documents between the monitor and keyboard to help reduce head, neck and eye movement. Versatile angle and height adjustments. Grooved shelf with raised edge supports books and catalogues. Transparent backplate, weighted base. Black. 40% recycled content.

**MMM DH630** (237321) 14 x 11 x 4 in.

**MMM DH640-AM** (644302) 18 x 11 x 4 in.



## B Professional Series In-Line Copy Holder

Places document between monitor and keyboard. The top and bottom sections offer 4-position adjustments to accommodate oversized documents. Locks at any angle from 0 to 90°. Magnetic line guide securely holds 250 pages. Stable weighted base. Unit folds for easy storage.

**FEL 8039401** (784496)

## C Copy Holder With Memo Board

3-in-1 copy holder, memo board and clip board. Dry erasable writing surface. Adjustable tilt. Folds flat for easy storage. Black/silver.

**FEL 8033201** (727396)



## D Euroholder Copy Holder

Adjusts to the user's correct reading angle. Height adjustable up to 4 in. Line guide can be placed on either left or right side. Faceplate can swivel left or right. Non-glare surface.

**DTA 17009** (768705)

## E Euroholder Easel Copy Holder

Ergonomic curved design. Reduces eye and neck strain. Line guide. Collapsible. Black.

**DTA 17008** (228833)

## F Ergo Copy Holder

Ergonomic curve helps keeping a good focal distance. Letter or legal size. Adjustable paper guide. Sold by each. Black.

**EXM 56109** (768424)



## G Insight Adjustable Copy Holder

Suitable for larger reports holding up to 50 sheets. Collapsible for easy storage. Sturdy enough to support a large book. Fits nicely between the keyboard and monitor for comfortable, ergonomic viewing.

**KMW 62058** (560078)

## H Curved Copy Holder

Adjustable document clip. Highlighted line guide. Will hold multiple pages. 10 x 2-1/2 x 14-3/8 in. H. Black.

**BSN 38951** (1012616)

## I Easel Copy Holder With Clip

Adjustable document clip. Highlighted line guide. Will hold multiple pages. 10-3/8 x 2-1/4 x 12-1/2 in. H. Black.

**BSN 38952** (1012624)

## J Easel Copy Holder

Adjustable document clip. Highlighted line guide. Will hold multiple pages. 10 x 2 x 14 in. H. Black.

**BSN 38950** (1012608)

## K Wire Book Holder

Supports 8-1/2 x 11 in. books at a comfortable reading angle. Works well for tablets too. Folds flat for storage or transport.

**MGE 1025726000** (1012574)



# Your Health, Our Priority



Your workspace should be more than a place where you work. It should inspire you. Improve your performance. Enhance your wellbeing. Move you. Our full range of workspace wellbeing solutions are designed to enable you to be healthier and more productive.

## ZONE 1

Prevent back tension



## ZONE 2

Avoid wrist pressure



## ZONE 3

Relieve neck strain



## ZONE 4

Reduce inactivity





# Raise Your View

## For a Healthy Outlook

Fellowes monitor arm solutions bring computer screens to the right position enabling home and office workers to be healthier and more productive.



Discover intuitive workspace solutions and healthy working advice at [www.fellowes.ca](http://www.fellowes.ca)

Work Better. Feel Better.™





A

**Fellowes**



B

**Fellowes**



**A Corsivo Sit-Stand Workstation**

Change positions easily with gas spring height adjustment. Work comfortably sitting or standing with 15.5 in of height adjustment. Two-tiered larger work surface can accommodate flexible set up options, holding two monitors or a monitor and a laptop. Keep your phone or other accessories within easy reach with the convenient device channel. 4.5 x 31.5 x 24.1 in. Black.  
**FEL 8091001** (828428)

**B Lotus LT Sit-Stand Workstation**

Gas spring height adjustment. Flexible set up. Spacious top platform holds two monitors, or a monitor and laptop and the bottom level perfectly holds a keyboard and mouse. Fully assembled. 4.3 x 31.5 x 24 in. Black.  
**FEL 8215001** (828429)

**C Lotus™ Convertible Sit Stand Workstation**

Lift counter balance technology and ergonomic handles make height adjustment easy and worry-free, while accommodating multiple user. 22 height adjustments and flush-to-desktop "down" position, offers experience stability at every setting. Intuitive cord management and charging device slot. Two work surfaces offer generous, useful space for your essential desk accessories. Fully assembled for quick and easy setup. 5-year warranty. Single or double monitor post sold separately.  
**FEL 0007901** (372425) black  
**FEL 0009901** (372433) white  
**With USB ports and wireless charging (android)**  
**FEL 8080301** (433896) black  
**FEL 8080201** (433888) white  
 • Lotus™ monitor arm  
**FEL 8042801** (386698) single  
**FEL 8042901** (386706) double



C

**Fellowes**



D

**3M**



**D Precision Sit-Stand Desk**

Gas assist continuous height adjustment allows you to move smoothly and quietly between sitting and standing positions in seconds. Height adjustment range from 6.2 to 20 in above the desk, accommodates a wide range of users. +10°/-10° keyboard surface tilt to help achieve comfortable typing position. Primary work surface is large enough to fit two 24 in. monitors and holds up to 35 lbs. Includes 3M™ Gel keyboard Wrist Rest and 3M™ Precise Mouse Pad. Pre-assembled. 45% post-consumer content.  
**MMM SD60B** (427054) black  
**MMMSD60W** (594879) white

**E Precision Standing Desk XL Easy Lift**

Gas assisted height adjustment provides smooth, quiet and continuous adjustment. Primary work surface large enough to accommodate 2 x 27 in. monitors and can be extended up to 20 in. above the desktop. Separate keyboard surface has adjustable tilt from +10°/-10° for an ergonomic typing position, in the sitting or standing position. 43 lb, pre-assembled. Black.  
**MMM SD70B** (594853)

**F Precision Standing Desk for Corner Desk**

Designed to fit 90° corner workstation. Gas assisted height adjustment provides smooth, quiet and continuous adjustment. Primary work surface large enough to accommodate 2 x 27 in. monitors and can be extended up to 20 in. above the desktop. Separate keyboard surface has adjustable tilt from +10°/-10° for an ergonomic typing position, in the sitting or standing position. 42 lbs, pre-assembled. Black.  
**MMM SD80B** (594861)



E

**3M**



F

**3M**

## A Height Adjustable Standing Desk Converter

Quick, easy, and stable height adjustment design. Can raise and lower up to 30 pounds. Holds up to two 32 in monitors and 23.6 in wide by 11.6 in deep retractable keyboard tray will hold a laptop if needed. 1-year limited warranty. 32 x 20-1/2 in.

**RCL R-ADRB** (829524) black  
**RCLR-ADRW** (828426) white

**Rocelco®**



## B Height Adjustable Corner Standing Desk Converter

Extra wide 46 in work surface will comfortably hold 2 or 3 monitors and/or a laptop while still providing lots of workspace. Moves straight up and down. Height adjustable from 5 to 18.1 in. 46 x 23-1/4 in.

**RCL R-CADRB-46** (829533) black  
**RCL R-CADRT-46** (829534) teak



## C Adjustable Desk Riser

Sturdy metal frame with easy-grip side handle and gas piston assist, can raise and lower up to 35 in with continuous height adjustment from 5 in up to 17 in. 37-1/2 x 20.5 in desktop that holds up to two 32 in monitors and retractable keyboard tray is 29-1/2 x 11.8 in. 37-1/2 x 23-1/2 in.

**RCL R-DADRB** (829526) black  
**RCL R-DADRW** (829527) white  
**RCL R-DADRG** (829528) grey  
**46 x 23-1/2 in.**  
**RCL R-DADRT-46** (829531) teak



## D Height Adjustable Standing Desk Converter

45-3/4 in. wide by 23-1/4 in. deep desktop holds up to 3 medium sized monitors or two large monitors. The 25-3/4 in. wide by 11-1/4 in. deep retractable keyboard tray will hold a laptop if needed. Ergonomic keyboard tray. Black.

**RCL R-DADRB-46** (829530)  
 • With additional 4 AC outlets and 2 USB ports  
**RCL 829532** (829532)  
 • With dual monitor arm and anti-fatigue mat.  
**RCL 829529** (829529)



## E Electric Standing Desk Converter

Dual monitor mount arm. 4 AC outlets and 2 USB 2.0 ports. 37.4 x 15.75 in work surface with electric lift system that raises up to 33 lbs. Black.

**RCL R-EDRB-DM2** (829537)



Electric

## F Hi-Lift Adjustable Desk Riser

29 x 10 in fixed keyboard tray. Easy-lift side handle. 31.5 x 17 in work surface. Holds up to 30 lbs. Black.

**RCL R-VADRB** (829536)



## G Portable Desktop Riser

Adjusts to any height up to 15 in above your work. Folds down to 1 in thin, and slips into its included portable carry pouch. Holds up to 11 lbs of weight. 10 x 19 in work surface. 1-year limited warranty. Sold by each. White.

**RCL R-PDRW** (829535)



Portable

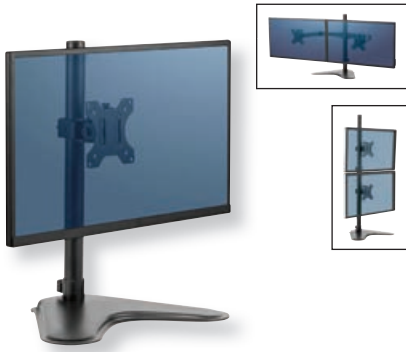

**A** **Felloses**



**B** **Felloses**



**A Professional Series Monitor Arm**

Free-standing monitor arm. Includes Quick Release plate for the screen. Intuitive cord management system. Holds monitors up to 30 in. and 17 lb (each arm). Meets VESA mounting standards.  
**FEL8049601** (828427) single arm  
**FEL 8043701** (433847) dual arm  
**FEL 8044001** (829552) 2 stacked monitors

**B Laptop Arm Adaptor**

Provides adjustability to lift laptop, or use a monitor and laptop on a dual monitor arm. Supports laptops up to 10 lb and up to 17". Attaches to VESA plates.  
**FEL 8044101** (433904)

**C Platinum Series Monitor Arm**

Fully independent adjustable monitor arms with innovative gas spring technology allows for effortless monitor adjustment. Intuitive cord management system. Two USB 3.0 ports. Easy to mount. Includes Quick Release plate for the screen. Each arm holds a monitor up to 20 lb. Meets VESA mounting standards.  
**FEL8043301** (433870) single arm  
**FEL8042501** (571877) dual arm (black)  
**FEL8056501** (829553) dual arm (silver)  
**FEL8043401** (571901) 2 stacked monitors  
**FEL8042601** (571893) triple arm



**C** **Felloses**

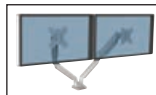

**D MM200B Dual Monitor Arm**

Sturdy steel construction holds two monitors up to 28.5 in. and 20 lb. each. Fully adjustable. Height: 15 in. range on pole. 360° rotation. Tilts +45° to -45°, pan +90° to -90°. Arm swivels 90°. Easily clamp mounts to surfaces up to 3.25 in. thick. Cord management clips on the arms and pole.  
**MMM MM200B** (577130)

**E SmartFit® One-Touch Adjustable Monitor Arm**

One-touch adjustable arm with built-in gas spring simplifies height adjustment (6.7-19.9 in), provides 180° swivel and monitor rotation, +/- 90° tilt adjustment. Supports 13-32 in. flat or curved monitor weighing up to 19.8 lbs. Easy to install. Cable management system. Meets ANSI/BIFMA performance and safety standards.  
**KMW8589655470** (598128) single arm  
**KMW 8589655471** (598136) dual arm



**D** **3M**



**E** **Kensington**



**F Desktop Monitor Mount**

Lightweight and sturdy aluminum construction. Independent and flexible tilt, rotation and swivel adjustments. Desktop mounting clamp. Single arm. Support monitor up to 10 kg. 16.81 x 7.36 x 3.86 in.  
**EXM 50902** (827867)

**G Articulating Monitor Arms**

Lightweight aluminum construction. Keyhole pattern for easy VESA plate installation. Pole height of 15.7 in with a reach of 17.75 in. Capacity of 17.6 lbs (per arm). Fits most monitors 17-32 inches. Tilt +30° to -30°, swivel +90° to -90°, rotation +180° to -180°. VESA mount plate for 75mm and 100mm. Clamp or grommet mount (both included). Built-in cable management clips. Metallic grey.  
**HZN AEG-20** (827939) dual arm  
**HZN AEG-15** (827938) single arm



**F** **EX2ONET**

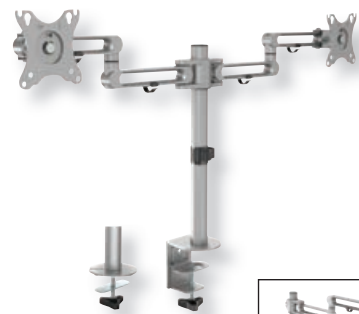

**G** **HORIZON SEATING**



## A Pedestal Monitor Arm

For 13-27" monitor. Capacity of 8 kg/17.6 lbs per arm. 90° horizontal tilt. Cable clip is included to organize cables. 360 degree rotating plate. Adjustable height for optimal ergonomic position. 33.1 x 12.4 x 18.3 in. Matte black.

**IKW MS302** (828071) dual arm  
**IKW MS303** (828072) triple arm



**A** IntekView



**B** IntekView



## B MS402 Double Monitor Arm

Accommodates most 17 to 27 in monitors. +45°~45° forward and back tilting and +40°~40° swivel combined with portrait to landscape ability increases productivity and functionality. A +40°~40° rotating base provides convenience for shared workspace and information sharing.

**IKW MS402** (828069) dual arm  
**IKW MS401** (828073) single arm

## C Dual Monitor Stand

Made of sturdy aluminum. Clamps for desktop mounting. Rotates 360 degrees. Features a 90 degree up and 15 degree down tilt. The tension knob allows multiple height adjustments. Maximum weight supported: 10 kg. Fits 10 to 30 inch screens. Black.

**EXM 50903** (829346)

## D SmartFit® Ergo Single Extended Monitor Arm

Delivers ±90° swivel, ±180° rotation (for landscape or portrait orientation), and ±45° monitor tilt adjustment for ergonomic comfort. Adjust the monitor's distance up to 15.7 in. Accommodates monitors up to 34 in. Durable steel and aluminum. Black.

**KMW K55408WW** (829488) single arm  
**KMW K55409WW** (829489) dual arm



**C** EXPONENT



**D** Kensington



## E Desk Monitor Mount/Stand

Fits three 13-27 in LCD/LED monitors up to 17.6 lbs each. Mounts to any surface up to 3.5 in thick. Double articulated arms make it easy to adjust monitors to any desired position. Black.

**RCL R-DM2** (829538) dual arm  
**RCLR-DM3** (829539) triple arm

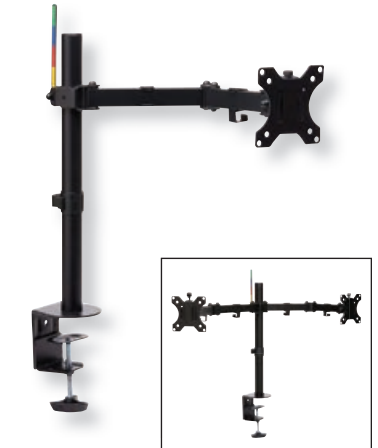

**E** Rocelco



**F** Rocelco



 <p><b>A</b> <b>3M</b></p>	 <p><b>B</b> <b>Kensington</b></p> <p>Disinfects keyboard, mouse, cell phone and more</p>	 <p><b>C</b> <b>Rocelco</b></p>	<p><b>A MS100B Monitor Stand</b> Holds up to 33 lb. Height adjustable from 2.76 to 3.94 in. Integrated 4-Port USB hub (3 USB 2.0 and 1 USB 3.0). Anti-slip rubber feet. 21.6 x 9.4 x 3.9 in. Black. <b>MMM MS100B</b> (829440)</p> <p><b>B Monitor Stand With UVC Sanitization Compartment</b> Eliminates up to 99.9% of bacteria and viruses on any exposed surface within 10 minutes. Supports up to 40 lb. 20 x 11 x 3.5 in. Black. <b>KMW K55100CA</b> (829487)</p> <p><b>C Dual Monitor Stand</b> For 2 monitors. 4 AC outlets and two USB 2.0 charging ports. Includes extra long 10 ft power cord. Works with regular desks, standing desks or sit-stand desk risers. Cable management slot. 30 x 9 x 4.75 in. Black. <b>RCL R-DMS</b> (829541)</p>
 <p><b>D</b> <b>Fellowes</b></p>	 <p><b>E</b> <b>Fellowes</b></p>	<p><b>D Premium Monitor Stand</b> Can be adjusted from 4 to 6 in. above work surface. Laptop stows comfortably under monitor riser. 27 in unit includes a media compartment and spill-resistant cup holder. Supports up to 80 lb. Black and silver. <b>FEL 8031001</b> (715227) 27 x 14-1/16 x 4-1/4 in. H <b>FEL 8031101</b> (189498) 20 x 14-1/16 x 4-1/4 in. H</p> <p><b>E Designer Suites™ Monitor Riser</b> Supports 40 lb. Height adjusts up to 1-5/8 in. (between 4-3/8 in. and 6 in.). Storage tray. Non-skid rubber feet. 4.38 x 16 x 9.38 in. Black/Pearl. <b>FEL 8038101</b> (189530)</p>	
 <p><b>F</b> <b>DAC ERGONOMICS</b></p>	 <p><b>G</b> <b>3M</b></p>	<p><b>F Stax® Adjustable Monitor Stand</b> Height adjustable from 1 to 4-3/4 in. Cable clip included. Supports monitors weighing up to 66 lb. Made from 30% recycled material. Black. <b>13 x 10-1/2 in.</b> <b>DTA 02161</b> (728527) without USB port <b>DTA 02159</b> (369520) 2 USB ports <b>22 x 10-1/2 in.</b> <b>DTA 02238</b> (369538) without USB port <b>DTA 02240</b> (369546) 2 USB ports</p>	
 <p><b>H</b> <b>DAC ERGONOMICS</b></p>	 <p><b>I</b> <b>DAC ERGONOMICS</b></p>	<p><b>G Monitor Stand</b> Contemporary design with stacking columns raises monitor up to 5-7/8 in. 11 in. clearance width underneath platform. Supports 80 lb. Non-skid base. Black/silver. <b>MMM MS80B</b> (145912) 15 in. wide <b>MMM MS90B</b> (145920) 20 in. wide</p> <p><b>H Stax® Corner Monitor Riser</b> For corner workstation. Height adjustable from 1 to 4.8. Heavy-duty ABS plastic construction. 19-1/2 x 11-1/2 in. triangular platform. Supports monitor up to 66 lb. 30% recycled content. Black. <b>DTA 02153</b> (369512) 2 USB ports <b>DTA 02184</b> (122036) without USB port</p>	
 <p><b>J</b> <b>EXPONENT</b></p>	 <p><b>K</b> <b>Kensington</b></p>	<p><b>I Monitor Riser Block</b> Stackable monitor riser blocks raise the computer by 1-1/4 in. each. Supports up to 77 lb. Sold by each. Black. <b>DTA 02151</b> (621342)</p> <p><b>J Stackable Monitor Stand</b> Height of 3.4 cm. Storage space for paper. Holds a 17 in. monitor. Stackable. Black. <b>EXM 56208</b> (700419)</p>	
 <p><b>L</b> <b>LORELL</b></p>	<p><b>L Adjustable Monitor Riser</b> Easily adjust height with removable feet like toy bricks. Surface top has a slot for pens, tablets or mobile phones. 19.8 x 7.9 x 4 in. Black. <b>LLR 99991</b> (1012541)</p>	<p><b>K SmartFit® Monitor Stand</b> Determine your SmartFit comfort colour, then set monitor to match by snapping 1 or 2 risers into place. Height adjusts to 1 to 3 vertical settings without tools. <b>KMW 8589660087</b> (189407) holds 40 lb <b>KMW 60089</b> (189415) holds 80 lb</p>	

## A SmartFit™ Laptop Riser

For laptops up to 14 in. Adjustable height up to 8.4 in for optimal alignment.

**Grey - 7.5 x 9.8 x 0.5 in.**  
**KMW K50421WW** (829485)  
**Black - 9.4 x 13 x 0.8 in.**  
**KMW K50422WW** (829486)



**A** **Kensington**



**B** **Felwos**



## B Laptop GoRiser™ Portable Riser

Folds flat to fit most briefcases. Non-skid surface. Cooling vents help prevent laptop from overheating. Supports up to 15.4 in laptops. 15 x 0.3 x 10.7 in. Black.

**FEL 8030401** (829554)



## C Height Adjustable Laptop/Tablet Stand

Suitable for 10-15 in laptops and most tablets. Height adjustable. Non-slip rubber base. 5 adjustment positions. Grey.

**IKW LR100** (829426)



**C** **IntekView**



**D** **Felwos**

## D Designer Suites™ Laptop Riser

5 viewing angles prevent neck and shoulder strain. Adjusts from flat to 30° angle. Supports laptops up to 25 lb. Stabilizing front edge. Cooling vents help dissipate heat. Provides space for USB hub. Black.

**FEL 8038401** (784488)



## E Office Suites™ Laptop Riser

Places your laptop at a comfortable viewing height. Holds up to 10 lb. Adjustable tilt. Stabilizing front edge. Non-skid rubber feet.

**FEL 8032001** (750729)



**C** **IntekView**



**D** **Felwos**

## F LX500 Adjustable Notebook Riser

Raise laptop to the ideal viewing position. Cooling slots. Built-in cable management. Adjusts up to 6 in. above desktop.

**MMM LX500** (717207)

## G Swivel Laptop Riser

Tilts up to 45°. Front edge brackets hold the notebook in place. Cooling vents help dissipate heat. 360° swivel base. Supports most laptops and docking stations up to 75 kg. Sold by each. Black.

**EXM 50601** (237230)

## H Laptop Riser

Suits 17 in. laptops up to 12 lb. Tilt adjustment. Front edge keeps laptop in place. Cooling vents help dissipate heat. Adjustable risers. 15.2 x 11.2 x 3.6 in. Black.

**EXM 56210** (189977)

## I Professional Laptop Workstation

Prevents neck strain. 9 different intuitive height adjustments. Cord management. USB hub with 4 ports. Writing surface with in-line document holder.

**FEL 8024601** (146514)

## J MP-195 Laptop Stand

Height and tilt adjustable. Sleek design, nearly invisible appearance. Natural air ventilation. Cable management system. Black.

**DTA 02177** (122028)



**E** **Felwos**

**F** **3M**



**G** **EXPOONENT**



**H** **EXPOONENT**



**I** **Felwos**



**J** **DAC ERGONOMICS**



**A** **Feljowes**



**B** **Feljowes**

**A Office Suites Mesh Back Support**

The mesh backrest molds to your body for support. Tri-tensioning™ attachment eliminates the need for re-adjustment and easily attaches to any chair. Mesh fabric allows air flow for your personal comfort. Fits all types of office chairs. 20.19 x 17.31 x 5.56 in. H. Black. **FEL 9191301** (828430)

**B Mesh Backrest**

Breathable mesh allows air to flow through. Elastic strap secures backrest in place. Reduces tension by maintaining the lumbar curve of your lower back. 17-1/2 x 3 x 15 in. H. Black. **FEL 8036501** (189522)

**C Professional Back Support**

Supports mid and lower back. Lower back support features three memory foam sections that conform to natural body curvature. 3-point attachment system ensures stability. Soft breathable fabric. **FEL 8037601** (147264)



**C** **Feljowes**



**D** **Feljowes**

**D I-Spire Series™ Lumbar Cushion**

Supports lower back for enhanced comfort while seated. Reduces back tension. Adjustable strap. Breathable mesh fabric enhances personal comfort. **FEL 9311603** (258533) grey **FEL 9472702** (353078) black

**E Lower Back Support**

Transforms ordinary chairs into ergonomically correct seating. "S"-shape molds your spine into a more anatomically correct position. Polycarbonate frame supports the natural contours of your spine. Removable and adjustable lumbar pad. Black. **HUL LB-BLK-CB** (303776)

**F High Back Support**

Polycarbonate S-shaped frame supports the natural contours of your spine. X-tall, support all back length, up to the neck and head. Removable and adjustable lumbar pad offers additional back support. Lightweight and portable, turns any chair into an ergonomic seating system. Black. **HUL HB-BLK-CB** (304113)



**E** **OBUSFORME®**



**F** **OBUSFORME®**

**G Side to Side Cushion With Massage**

Massage setting to relax lower back. Gently supports the natural lumbar curvature of the spine. Enhances overall posture by supporting proper spinal alignment. Made with high-density polyurethane foam. Adjustable elastic straps. Battery operated (2 x AA, not included). Black. **HUL SS-BLK-01** (304105)

**H Premium Cool-Gel Seat Cushion**

Cooling fabric with cool-gel core provides a certified decrease in body temperature for maximum comfort during extended periods of sitting. Ergonomic design promotes healthy posture, improves circulation, and relieves spinal pressure. Zero tailbone pressure alleviates pressure on your spine using a unique u-shaped coccyx cutout to support sciatica relief by minimizing contact between tailbone and seat cushion. Premium honeycomb memory foam. Provide ongoing support, and keep seams intact beyond 80,000 uses. Machine-washable cover with anti-slip backing. Black. **KMW 8589655807** (572875)



**G** **OBUSFORME®**



**H** **Kensington**



**A Ergonomic Tiltable Steel Foot Rest**

The easy-glide design improves circulation by allowing repositioning of legs and feet while the footrest is in use. Tilt angle slides easily to any position. Anti-slip rubber pads. 14.9 x 11.8 x 3 in. Black. **IKW FR200** (828070)



**A** IntekView



**B** Fellowes

**B Climate Control Footrest**

Platform offers 2 height settings and 3 tilt angles. Radiates safe, even heat on low or high setting. Fan lets you adjust workspace airflow. Works also as a free-standing climate control unit. Surface massage bumps. **FEL 8040901** (122010)

**C Professional Series™ Ultimate Footrest**

Elevates feet and legs to relieve lower back pressure. Scissor motion height adjustment (10, 13.5, 16.5 cm). No fixed angle, allowing rocking motion improves circulation. Black. **FEL 8067001** (189548)



**C** Fellowes



**D** Kensington

**D Solemate™ Comfort Footrest**

Provides greater leg, back, and foot comfort. Luxurious memory foam soothes tired feet and eliminates pressure points. Angle adjusts with a foot pedal control. Height adjustable from 3.5 to 5 in. with SmartFit system. **KMW 56144** (228734)

**E Offix® F6018 Footrest**

Bumpy surface produces massage effect. Easy gliding angle adjustment from 0 to 30°. Made of high-impact polystyrene. Non-slip base. 8.9 x 33 x 45.1 cm. Graphite. **NVX 344499** (344499)



**E** offix



**F** Fellowes

**F Footrest**

Tilting up to 22°. 2-position height adjustment (3.5 - 4.375 in. height). Textured surface stimulates tired feet. Black. **FEL 48121** (699280)

**G Adjustable Footrest**

Heavy-duty plastic. Unique texture surface relieves foot fatigue. 6 height adjustments. Black. **EXM 51102** (699645)



**G** EXPONENT



**H** Kensington

**H Solesaver Footrest**

Dual height adjustment. 2-position tilt adjustment (10° and 15°). Non-slip textured surface. **KMW 56152** (711010)

**I Office Suites™ Adjustable Footrest**

Adjust tilt angle using foot pressure. Locking mechanism or free floating tilt action. 3-position height adjustment. Black and silver. 8 x 17 x 12-1/2 in. **FEL 8032201** (727610)



**I** Fellowes

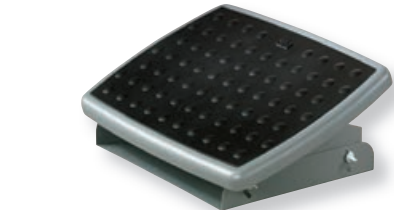

**J** 3M

**J FR330 Adjustable Footrest**

Steel base with 18 in wide non-skid plastic platform with soft bumps to massage and soothe your feet. Independent height and tilt adjustments. Black. **MMM FR330** (727958)

**K The Ultimate Footrest**

Ergonomic design. Reflexology foot massage surface. Self-adjustment with silent movement. Black. **DTA 02119** (728535)



**K** DAC ERGONOMICS



**L** 3M

**L Foot Rest for Standing Desk**

Can be used in rocking position to move feet back and forth or simply flip over with your foot to a stationary position and alternate lifting your legs and feet to the surface helping to reduce fatigue. 4.2 x 19.98 x 11.97 in. Black. **MMM FR200B** (807339)



**A** EX2ONENT



**B** emzone

**A Screen Cleaning Wipes**

Pre-moistened and individually wrapped. 75% isopropyl alcohol. Anti-static and non-streaking. 5 x 6 in. Box of 25.  
**EXM 77500** (147322)

**B Screen Cleaning Wipes**

Non-flammable and alcohol free. This product can also be used on keyboards, telephones and other office equipment. Box of 50.  
**EMP 47044** (571182)

**C Pre-Moistened Wipes**

Pre-moistened ready to use wipes. No alcohol. Biodegradable and anti-static. Package of 100.  
**EXM 77505** (208546) multipurpose  
**EXM 77506** (249102) for screens



**C** EX2ONENT



**D** emzone

**D Cleaning Wipes**

From keyboards to countertops to office equipment these lint free wipes will safely clean surfaces without scratching, dripping, or streaking. Package of 100.  
**EMP 47091** (553156) multipurpose  
**EMP 47090** (562496) for screens

**E Foam Screen Cleaner With Cloth**

Cleans safely. Does not contain ammonia. Microfiber cloth easily wipes LED, LCD and plasma screens and leaves a perfect shiny finish. 400 g.  
**EMP 47046** (538892)

**F Screen Magic Cleaner**

Cleans and protects all LCD and Plasma screens. No CFC. With cleaning cloth included. 16 oz.  
**EXM 77201** (791046)  
 • Package of 2 microfibre cloths  
**EXM 77202** (791053)



**E** emzone



**F** EX2ONENT



**G Screen Cleaner & Microfibre Cloth Pack**

Safely cleans computer/ monitors, laptops, tablets, GPS devices, game consoles and smartphones. Includes 1 screen cleaner of 118 ml and 1 microfibre cloth.  
**EMP 47066** (562488)

**H Screen Cleaner Foam With Cloth**

Safely cleans. Includes 2 spray bottles and 2 microfibre cloths that easily wipes LED, LCD & plasma screens leaving your product with a flawless shine.  
**EMP 47072** (533729) foam  
**Safe antistatic - 2 x 118 ml**  
**EMP 47071** (1014331) liquid  
 • Package of 3 microfibre cloths  
**EMP 47067** (524439)



**G** emzone



**H** emzone



**I Precision Air Duster**

Good for precision cleaning of hard to reach areas. Blows away dust, dirt and microscopic debris with one squeeze. 100% safe for the ozone. Sold by each.  
**EXM 77000** (359273) 10 oz  
**EXM 77001** (785352) 3.5 oz



**I** EX2ONENT



**J** emzone



**K** offix



**J Emzone Air Duster**

Good for precision cleaning of hard to reach areas. Pulverise dust, dirt and microscopic debris with one squeeze off office electronics equipment and automobile.  
**EMP 47020** (1014273) each (10 oz)  
**EMP 47036** (571455) pkg 2 (3.5 oz)

**K Offix® Air Duster**

100% ozone safe. Ideal for cleaning the keyboard and other electronic equipments. 10 oz.  
**NVX 347104** (347104) each  
**NVX 804435** (804435) pkg 6

## A Câble HDMI

2 gold-plated HDMI (male) connectors. Supports 1080p+ resolutions at up to 120Hz refresh rate.  
**STC HDMM3** (832118) 3 ft.  
**STC HDMM6** (832119) 6 ft.  
**STC HDMM10** (832120) 10 ft



**A** StarTech.com



**B** StarTech.com



## B HDMI 2.1 Cable

Certified ultra high speed HDMI cable 48Gbps - 8K 60Hz/4K 120Hz.  
**STC HDMM21V1M** (832121) 3 ft.  
**STC HDMM21V2M** (832122) 6 ft.  
**STC HDMM21V3M** (832123) 10 ft.

## C VGA Cable

Two HD15 (male) connectors. Ideal for high resolution monitors (1920x1200 and above).  
**STC 832130** (832130) 3 ft.  
**STC 832131** (832131) 10 ft.



**C** StarTech.com



**D** StarTech.com



## D Display Port to HDMI Adapter Cable

Supports video resolutions up to Ultra HD 4K. 6 feet.  
**STC DP2HDMM2MB** (832133)

## E USB-C to HDMI Adapter Cable

The adapter offers a connection distance of up to 2 m (6 ft.) and works with USB-C devices that support DP Alt Mode. It's also compatible with Thunderbolt 3 ports.  
**STC 832134** (832134)

## F DisplayPort to VGA Cable

Standard DisplayPort™ Male to 15-pin VGA Male cable. Gold-plated connectors. Shielded for EMI/RFI interference. Resolution up to 1920 x 1080 (Full HD 1080p). 6.56 feet.  
**CBB CAC-1012** (832542)



**C** StarTech.com



**D** StarTech.com



## G HDMI Cable

To connect digital displays such as HDTV's, plasma display, DLP TV, LCD TV's, and projectors. Sold by each.  
**EXM 57560** (123984) 6 ft  
**EXM 57561** (237263) 10 ft  
**EXM 57562** (237271) 15 ft

## H Mini DisplayPort 1.4 to DisplayPort Extension Cable

Support resolutions up to 8K @ 60Hz and 4K @ 144Hz. The Cable is 32AWG and fully Bi-Directional. 1m/3.28ft.  
**CBB CAC-1120** (832545)

## I DisplayPort 1.4 HBR3 8K 28AWG Cable

Support resolutions up to 8K @ 60Hz and 4K @ 144Hz. Without DSC 1.2 max resolution supported up to 5K @ 60Hz. 3m /9.84ft  
**CBB CAC-1060** (832548)

## J High speed HDMI Cable

To connect digital displays such as HDTV's, plasma display, DLP TV, LCD TV's, and projectors. Compatible with even Ultra High Speed (4K x 2K).  
**CCS 11160** (1013283) 6'  
**CCS 11161** (1013275) 12'



**E** StarTech.com



**F** Club<sup>®</sup>  
Superior Quality



**G** EXPONENT



**H** Club<sup>®</sup>  
Superior Quality



**I** Club<sup>®</sup>  
Superior Quality



**J** COMPUTCESSORY<sup>®</sup>



**A** StarTech.com



**B** StarTech.com

**A USB-C to HDMI Adapter**

Hassle-free connection with the reversible USB-C connector. Thunderbolt 3 port compatible.  
**STC CDP2HD** (371153)

**B Mini DisplayPort to HDMI Video Adapter Converter**

Crystal clear picture quality with support for high-definition video resolutions up to 1080p. Compatible with Thunderbolt 1 and Thunderbolt 2 ports.  
**STC NDP2HDMI** (579458)

**C HDMI to VGA Adapter**

Support for resolutions up to 1080p (1920 x 1080). 3-year warranty.  
**STC HD2VGAE2** (591248)

**D HDMI and VGA to USB-C Adapter**

Supports a single HDMI display at resolutions up to 4K 60Hz, a single VGA display at resolutions of up to 1920x1200 60Hz or dual-mirrored HDMI and VGA displays at resolutions of up to 1080p.  
**STC 832132** (832132)



**C** StarTech.com



**D** StarTech.com

**E DisplayPort to HDMI Video Converter**

Connect your HDMI monitor or HDTV to a DisplayPort equipped computer. Supports resolutions up to 1920x1200 / 1080p.  
**STC DP2HDMI2** (591297)

**F MST Hub DisplayPort 1.4 to DisplayPort + HDMI**

4K 60Hz M/F. Externally powered by a USB Type-A to Micro USB cable.  
**CBB CSV-7220** (832544)

**G DisplayPort™ to VGA Black Active Adapter M/F**

Supports resolutions up to WUXGA 1920x1200p @ 60Hz.  
**CBB CAC-2013** (832547)



**E** StarTech.com



**F** Club Superior Quality

**H Mini DisplayPort 1.4 to HDMI**

Support resolutions up to 4K @ 120Hz.  
**CBB CAC-1186** (832546)

**I VGA to HDMI Adapter**

Convert the VGA port on your computer into an HDMI output port. Supports video resolution up to 1920 x 1080. USB powered.  
**STC VGA2HDU** (355206)



**G** Club Superior Quality



**H** Club Superior Quality



**I** StarTech.com

## A UH720 USB Hub

7 USB 3.0 ports enable you to connect devices such as external hard drives and thumb drives to your Windows, Mac, or Linux computer.

2-year limited warranty. Black

**UH720 - 7-port hub with 2 charging ports**

**TPL UH720** (831671)

**UH700 - 7-port hub**

**TPL UH700** (831689)



## B Mini USB Hub

Expand your USB connectivity by turning a single USB-A 3.0 port into four external USB-A 3.0 ports. Offers data transfer rates of up to 5Gbps.

2-year limited warranty. Black.

**STC 832101** (832101)

## C 4-Port Portable USB 2.0 Hub with Built-in Cable

Powers directly from your computer's USB port. Installs automatically when you connect it to your laptop or desktop. Black.

**STC 571604** (571604)



## D 4-Port Portable USB 3.0 Hub

Travel-friendly, with a compact and lightweight aluminum casing, and an integrated, extended-length cable. Silver

**STC ST43004UA** (385393)



## E USB-C TO USB- A Adapter - M/F

Convert your USB Type-C port to USB Type-A. USB 3.0 supports up to 5 Gbps. Compatible with Thunderbolt 3 port. 2-year limited warranty. Black.

**STC USB31CAADP** (832111)

## F MicroUSB Port to USB Cable

High quality braided cable ensures durability and reduces tangles. 4 ft. Champagne.

**VER 99220** (513945)



## G MicroUSB Port to USB Cable

Extra durable, braided design resistant to wear and tear. Tangle-free. Works with all USB car and wall chargers. 4 ft. Black.

**BEE B4MICBK** (577940)

## H USB-C to USB-C Cable

Transfer speeds of up to 5 Gbps. Durable nylon braided cable minimizes tangles. 1-year limited warranty. 47 in. Black.

**VER 99674** (585117)





**A** StarTech.com



**B** StarTech.com



**A USB-A to USB-C Cable**

Connect your USB 3.0, USB-C devices to the USB-A port on your computer or charger. Supports data transfer rates of up to 5Gbps. 2-year limited warranty. 3 ft. Black.  
**STC USB315AC1M** (832112)

**B USB-C to USB-B Cable**

Connect your USB 3.0 peripheral devices, such as a printer, external drive or docking station to your USB Type-C laptop or tablet. The cable is also compatible with Thunderbolt 3 ports. 2-year limited warranty. 6 ft. Black.  
**STC USB315CB2M** (832116)

**C USB-C to USB-C Cable**

USB 3.2/3.1 Gen. 1. The cable is also compatible with Thunderbolt 3 ports. 2-year limited warranty. Grey and black.  
**STC 832117** (832117)



**C** StarTech.com



**D** StarTech.com



**D USB-A to USB-C Cable**

Compatible with your Thunderbolt 3 ports. Cable has aramid fibre reinforcement that shelters it from the stress of frequent bends.  
**STC RUSB2AC1MB** (832113) 3 ft.  
**STC RUSB2AC2MB** (832114) 6 ft.

**E USB C to USB C Cable**

Use this 6ft USB-C to USB-C cable to power and charge a USB-C laptop or phone. Compatible with Thunderbolt 3 ports and offers data transfer rates of up to 5Gbps. 2-year limited warranty. Black.  
**STC USB315C5C6** (832115)

**F USB-C to USB-C M/M Cable**

Connect more easily with reversible USB Type-C connectors, which can plug into your devices with either side facing up. Plug into wall charger or USB-C devices. Thunderbolt 3 port compatible. 3 ft. Black.  
**STC USB2CC1M** (371179)



**E** StarTech.com



**F** StarTech.com

**G Pro Series A/A USB Cable**

Type A Male to Type A female cable. Supports data transmissions at up to 480Mbps. Simple plug-and-play connectivity. 6 ft.  
**BLK F3U153BT** (584326)

**H Series A Male/B Male USB Cable**

Fast transfer rates. Connects a wide range of peripherals for PC or Mac. Universal serial outlet. USB 3.0. 6 ft.  
**EXM 57563** (237883)

**I USB Cable Extension - A Male / A Female**

Connects a wide range of peripherals for PC or Mac. USB 3.0. 6 ft.  
**EXM 57564** (238550)

**J Series A Male/B Male USB Cable**

Fast transfer rates. Connects a wide range of peripherals for PC or Mac. Universal serial outlet. USB 2.0.  
**EXM 57545** (699694) 6 ft.  
**EXM 57546** (699686) 10 ft.  
**EXM 57547** (533778) 15 ft.



**G** belkin



**H** EX2ONENT



**I** EX2ONENT



**J** EX2ONENT

## A PCIe Network Adapter

A PCIe adapter helps build a lightning fast transport channel between a central server and other working machines in your local network. 2-year limited warranty.

**TPL TX401** (831442) red - 10GB

**TPL TG-3468** (831443) green - 32GB

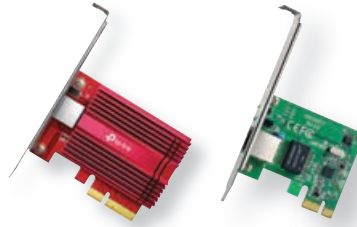

**B** StarTech.com



## B USB-C to Ethernet Adapter

The USB-C to LAN adapter supports full Gigabit bandwidth at 10/100/1000Mbps network speeds with checksum offload (IPv4, IPv6, TCP, UDP) and large-send offload support. 2-year limited warranty.

**STC US16C30B** (832253)

## C USB-A to Ethernet Adapter

Add a Gigabit network port to your computer through a USB 3.0/3.2 Gen 1 Type-A port, supporting multiple speeds (10/100/1000 Mbps). 2-year limited warranty.

**STC USB31000S2** (832340)

## D USB to Ethernet Adapter

Enables a fast Ethernet network connection capability for desktops and notebooks

**CBB CAC-1420** (832537) USB 3.2 Gen1 Type-A

**CBB CAC-1520** (832538) USB-C



**C** StarTech.com



**D** Club



## E UTP Cat5e Cable

**STC RJ45PATCH3** (832135) 3 ft.

**STC RJ45PATCH7** (832136) 7 ft.

**STC 832137** (832137) 15 ft.

**STC 832138** (832138) 25 ft.

**STC 832139** (832139) 50 ft.



**E** StarTech.com



**F** StarTech.com



## F UTP Cat6 Cable

**STC N6PATCH3BL** (832140) 3 ft.

**STC N6PATCH7BL** (832141) 7 ft.

**STC 832142** (832142) 15 ft.

**STC 832221** (832221) 25 ft.

**STC 832242** (832242) 50 ft.

## G Network Cable

2 RJ-45 connectors. Blue.

**Category 5, 300 Mbps**

**EXM 57271** (655399) 3 ft.

**EXM 57277** (655407) 7 ft.

**EXM 57283** (652438) 14 ft.

**EXM 57289** (652453) 25 ft.

**EXM 57295** (727594) 50 ft.

**Category 6, 1250 Mbps**

**EXM 57541** (123851) 7 ft.

**BLK F3U153BT** (584326) 14 ft.

**EXM 57543** (123877) 25 ft.

## H USB A Male/ A PCB Female Extension

USB 2.0.

**EXM 57467** (655506) 6 ft.

**EXM 57548** (711168) 10 ft.



**G** EX2ONENT

**H** EX2ONENT



## J Cord Concealer

Designed to conceal cords that run across your floor or countertop. Double-sided adhesive tape included. Flexible material allows to cut and fit to the desired length. 6 ft. Grey.

**BLK F8B023** (146530)



**I** VELCRO

**J** belkin



# Wi-Fi Made Easy

Home and Office Networking



Omada's Software Defined Networking (SDN) platform integrates enterprise-level network devices, including access points, switches, and gateways, providing 100% centralized cloud management. TP-Link's SOHO lineup of products has been #1 for 11 years, providing everything from Range Extenders, Adapters, Routers, to its Deco seamless-roaming mesh solution.





## A 10/100Mbps Desktop Switch

All ports support auto-MDI/MDIX, eliminating the need to worry about the type of cable to use. Provides 10/100Mbps Auto-Negotiation RJ45 ports. Limited lifetime warranty.

**TPL TL-SF1005D** (831517) 5 ports (white)

**TPL TL-SF1008D** (831515) 8 ports (white)

**TPL TL-SF1016D** (831512) 16 ports (black)



**A**

## B (PoE+) Switch

Compliant with the 802.3af/at PoE+ standard supports up to 30 W on each PoE port. Dedicated Design for IP Surveillance—Up to 250 m Transmissions. Limited lifetime warranty.

**5 ports (4 PoE+) 67W**

**TPL TL-SF1005P** (831560)

**8 ports (4 PoE+) 66W**

**TPL TL-SF1008P** (831559)

**9 ports (8 PoE+) 65W**

**TPL TL-SF1009P** (831556)



**B**

## C 48-Port 10/100Mbps Rackmount Switch

All 48 ports support auto MDI/MDIX, no need to worry about the cable type. Provides 48 10/100Mbps Auto-Negotiation RJ45 ports. Limited lifetime warranty.

**TPL TL-SF1048** (831510)

## D 8-Port Gigabit Desktop/Rackmount Switch with 8-Port PoE+

All 8 ports supporting the PoE+ standard. With a total power budget of 126W, up to 30W per port, can power more high-powered devices such as wireless Access Points (APs), IP Cameras or IP Phones. Limited lifetime warranty.

**TPL TLSG1008MP** (831539)



**C**

## E Port Gigabit Desktop Switch with Port PoE

Compliant with the 802.3af/at PoE+ standard supports up to 30 W on each PoE port. Fully compatible with IP cameras, access points, IP phones, computers, printers, and more. Limited lifetime warranty.

**TPL TL-SG1005P** (831541) 5 ports

**TPL TL-SG1008P** (831540) 8 ports

## F Port Gigabit Easy Smart Switch

Effectively monitor traffic via port mirroring, loop prevention and cable diagnostics features. Additionally, port-based, tag-based and MTU VLAN can improve security and meet more network segmentation requirements. Limited lifetime warranty.

**TPL TL-SG105E** (831495) 5 ports

**TPL TL-SG108E** (831491) 8 ports

## G Port Gigabit Easy Smart Switch with Port PoE+

16 ports with 8 ports supporting the PoE+ standard. Total power budget of 110W, up to 30W per port. Limited lifetime warranty.

**TPL TL-SG105PE** (831538) 5 ports (4 ports PoE+)

**TPL TL-SG108PE** (831535) 8 ports (4 ports PoE+)

**TPL TLSG1016PE** (831534) 16 ports (8 ports PoE+)



**D**



**E**



**F**



**G**



**A**

**A Port Gigabit Rackmount Switch**

A high-performance, low-cost, easy-to-use, seamless and standard upgrade to improve old network to 1000Mbps network. All 16 ports support auto MDI/MDIX. Limited lifetime warranty.

- TPL TL-SG105** (831505) 5 ports
- TPL TL-SG108** (831504) 8 ports
- TPL TL-SG1016** (831501) 16 ports
- TPL TL-SG1024** (831499) 24 ports
- TPL TL-SG1048** (831498) 48 ports

**B Port Gigabit Desktop/Rackmount Switch**

Features the latest innovative energy-efficient technologies that can greatly expand your network capacity with much less power. It automatically adjusts power consumption according to the link status and cable length to limit the carbon footprint of your network. Limited lifetime warranty.

- TPL TL-SG1005D** (831508) 5 ports
- TPL TL-SG1008D** (831507) 8 ports
- TPL TL-SG1016D** (831502) 16 ports
- TPL TL-SG1024D** (831500) 24 ports

**B**



**C Port Gigabit Easy Smart Switch**

Effectively monitor traffic via port mirroring, loop prevention and cable diagnostics features. Additionally, port-based, tag-based and MTU VLAN can improve security and meet more network segmentation requirements. Limited lifetime warranty.

- TPL TlSG1016DE** (831489) 16 ports
- TPL TlSG1024DE** (831486) 24 Ports

**C**



**D 8-Port 2.5G Desktop Switch**

Provides up to 25/40 Gbps of switching capacity. Unlock the highest performance of 2.5G multi-gig bandwidth and devices. Powerful performance for smooth LAN parties. Limited lifetime warranty.

- TPL TlSG108M2** (831497)

**E 16-Port Gigabit Desktop Switch**

Provides you an easy way to make the transition to Gigabit Ethernet. Increase the speed of your network server and backbone connections. Plug and Play design, with no configuration required. Limited lifetime warranty.

- TPL TL-SG116** (831503)

**D**



**F 16-Port Gigabit Unmanaged Pro Switch**

Provides an easy way to expand your wired network. 16 non-blocking 10/100/1,000 Mbps ports make it possible to transfer large, bandwidth-intensive files with no interference. Limited lifetime warranty.

- TPL TL-SG116E** (831490)

**E**



**G JetStream 16-Port Gigabit Easy Smart PoE+ Switch with 2 SFP Slots**

Compliant with the 802.3af/at PoE+ standard supports up to 30 W on each PoE port. Fully compatible with IP cameras, access points, IP phones, computers, printers, and etc. Limited lifetime warranty.

- TPL 831533** (831533)

**F**



**G**





## A 28-Port Gigabit Easy Smart Switch with 24-Port PoE+

Fully compatible with PoE devices, such as IP cameras, access points, and IP phones. It also works with non-PoE wired devices to provide gigabit connections, such as PCs, printers, and IPTV. Compliant with the 802.3af/at PoE+ standard supports up to 30 W on each PoE port. Limited lifetime warranty.

**TPL TLSG1428PE** (831532)

## B 8-Port Gigabit Switch

8 Gigabit Ethernet ports, one of which supports PoE in as an alternative to using the included AC power adapter when connected to compatible equipment. With its 16 Gb/s switching capacity and 11.9 Mpps forwarding rate. Limited lifetime warranty.

**TPL TLSG2008V3** (831484)

## C JetStream Smart Switch

Fully compatible with PoE devices, such as IP cameras, access points, and IP phones. Designed to use a single Ethernet cable for both data and power transmission. Limited lifetime warranty.

**8-port Gigabit PoE with 8 ports PoE+**

**TPL TL-SG2008P** (831531)

**61 W | 10-port Gigabit PoE with 8 ports PoE+**

**TPL TL-SG2210P** (831530) 61 W

**150 W | 10-port Gigabit PoE with 8 ports PoE+**

**TPL TLSG2210MP** (831529)

**28-port Gigabit PoE avec 24 ports PoE+**

**TPL TL-SG2428P** (831527)

## D JetStream 28-Port Gigabit L2 Managed Switch with 24-Port PoE+

Features 24? 802.3af/at compliant PoE+ ports, the switch supports up to 384 W total PoE power budget. Software Defined Networking (SDN) with Cloud Access.

**TPL TLSG3428MP** (831526)

## E JetStream 24-Port Gigabit and 4-Port 10GE SFP+ L2+ Managed Switch with 24-Port PoE+

Features 24? 802.3af/at compliant PoE+ ports, the switch supports up to 384 W total PoE power budget. Designed to use a single Ethernet cable for both data and power transmission. Limited lifetime warranty.

**TPL 831523** (831523)

## F JetStream 52-Port Gigabit L2+ Managed Switch with 48-Port PoE+

Omada's Software-Defined Networking (SDN) platform integrates network devices, including access points, switches, and routers, providing 100% centralized cloud management. Omada creates a highly scalable network—all controlled from a single interface. Limited lifetime warranty.

**TPL TL-SG3452P** (831522)

## G JetStream 24-Port 10/100Mbps + 4-Port Gigabit Smart Switch with 24-Port PoE+

TP-Link smart switch TL-SL2428P is equipped with 24 10/100Mbps RJ45 ports, 4 10/100/1000Mbps RJ45 ports and 2 combo Gigabit SFP slots. All of the 24 10/100Mbps RJ45 ports support the 802.3at/af (PoE+) standard with total PoE power budget of 250 W and useful PoE power management features. Limited lifetime warranty.

**TPL TL-SL2428P** (831543)



A



B



C



D



E



F



G

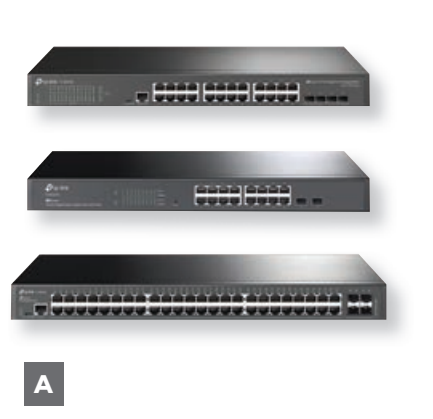

**A Port Gigabit + SFP Switch**

Omada's Software Defined Networking (SDN) platform integrates network devices, including access points, switches and gateways, providing 100% centralized cloud management. Omada creates a highly scalable network—all controlled from a single interface.

- 16-Port Gigabit + 2 SFP**  
**TPL TL-SG2218** (831483)
- 24 ports Gigabit + 4 SFP**  
**TPL TL-SG3428** (831482)
- 48-Port Gigabit + 4 SFP**  
**TPL TL-SG3452** (831480)

**B 24-Port Gigabit + 4x 10G SFP+ Switch**

4x 10 Gbps SFP+ slots provide non-blocking switching performance and ultra-low latency, so reliable and lightning-fast connections to server and other switches are easily built.

**TPL TL-SG3428X** (831481)

**C 16-Port 10/100 Mbps + 2-Port Gigabit Rackmount Switch with 16-Port PoE+**

Compliance with the 802.3af/at PoE+ standard supports up to 30 W on each PoE port. The total 250 W PoE power budget for the 16 PoE+ ports makes it has wide range of applications, such as surveillance, offices, dormitories, and small businesses.

**TPL TLSL1218MP** (831546)

**D 150W 16-Port PoE+ Switch**

Compliance with the 802.3af/at PoE+ standard supports up to 30 W on each PoE port. The total 150 W PoE power budget for the 16 PoE+ ports makes it has wide range of applications, such as surveillance, offices, dormitories, and small businesses.

**TPL TL-SL1218P** (831547)

**E 124W 11-Port (8 PoE+) Switch**

Compliance with the 802.3af/at PoE+ standard supports up to 30 W on each PoE port. The total 124 W PoE power budget for the 8 PoE+ ports opens up a wide range of applications, such as surveillance for offices, dormitories, and small businesses.

**TPL TL-SL-1311MP** (831554)

**F 8-Port 10G Desktop/Rackmount Switch**

As the flagship 10G product, TL-SX1008 is an 8-port 10G desktop/rackmount switch, providing up to 160 Gbps of switching capacity. Auto-negotiation 5-speed (100Mbps/1G/2.5G/5G/10G) connections sense the link speeds and intelligently adjust for compatibility and optimal performance for all your devices, including 10G NAS, 10G server, workstation, gaming computer, 2.5G/5G/10G WiFi 6 AP, 8K video, desktop, and more. Limited lifetime warranty.

**TPL TL-SX1008** (831496)

**G 8-Port 10Gb SFP+ Switch**

Build and expand your lightning-fast network with TP-Link TL-SX3008F—a fully managed switch with full 8-port 10G fibre ports and 160 Gbps switching capacity. Ideal for small, medium, and large business networks, it meets and surpasses the needs for high-speed, reliable, and safe enterprise networks. Seamless Integration to Omada Cloud SDN. Limited lifetime warranty.

**TPL TL-SX3008F** (831479)

**H JetStream 16-Port 10GE SFP+ L2+ Managed Switch**

Build and expand your lightning-fast network with TP-Link TL-SX3016F—a fully managed switch with full 16-port 10G fiber ports and 320 Gbps switching capacity. Ideal for small, medium, and large business networks, it meets and surpasses the needs for high-speed, reliable, and safe enterprise networks. Seamless Integration to Omada Cloud SDN. Limited lifetime warranty.

**TPL TL-SX3016F** (831374)



## A Omada Gigabit VPN Router

1 gigabit SFP and 5 gigabit RJ45 ports provide high-speed wired connectivity. Supports up to 100? LAN-to-LAN IPsec, 50? OpenVPN, 50? L2TP, and 50? PPTP VPN connections.

**TPL TL-ER7206** (831464)

## B Omada Gigabit VPN Router

1 gigabit WAN port and 2 gigabit WAN/LAN ports with load balance raise the utilization rate of multi-line broadband. Supports up to 20? LAN-to-LAN IPsec, 16? OpenVPN, 16? L2TP, and 16? PPTP VPN connections.

**TPL ER605** (831465)

## C Load Balance Broadband Router

Up to 4 WAN ports equipped with advanced load balance to guarantee maximum bandwidth and backup capabilities. Portal authentication enables efficient network management. Marshals bandwidth resource to specific clients based on their unique application environments.

**TPL 831466** (831466)

## D Load Balance Broadband Router

Up to 4 WAN ports equipped with advanced load balance to guarantee maximum bandwidth and backup capabilities. Provides extensive client account and network management for administrators with supported PPPoE Server. Marshals bandwidth resource to specific clients based on their unique application environments. Smaller case for cost-effective solution in the small office or Internet cafes network.

**TPL 831467** (831467)

## E Omada Hardware Controller

OC300, the professional on-premises hardware controller for the Omada Software Defined Networking (SDN) platform, provides 100% centralized management of Omada access points, JetStream switches, and Omada routers—all controlled from a single interface. Featuring hybrid cloud technology, the Omada Hardware Controller OC300 allows you to remotely control the whole network wherever you are in the world with cloud access. Limited lifetime warranty.

**TPL OC300** (831468)

## F Omada Hardware Controller

The OC200 Omada Hardware Controller provides centralized management of the whole Omada network. Monitor statistics in real-time, view a graphical analysis of network traffic, create a captive portal, upgrade and reboot your system, and effortlessly scale your network to boost your business. Omada SDN—Smarter Cloud Solution for Business Networking. Limited lifetime warranty.

**TPL OC200** (831469)

## G Omada AC1200 Wireless MU-MIMO Gigabit Wall Plate Access Point

An EAP in each room allows guests to enjoy their own private Wi-Fi network that's fast, delivering a strong signal, and providing corner to corner coverage. The thinnest wall plate AP available—only 15 mm—featuring a sleek, minimalist appearance. Designed to blend in with the décor of hotel rooms, hospitals, offices and school dormitories, to deliver powerful Wi-Fi without clashing with the room. Limited lifetime warranty.

**TPL EAP235WALL** (831477)



A



B



C



D



E



F



G



**A**



**B**



**C**



**D**



**E**



**F**



**G**



**H**

**H AC1200 Wireless MU-MIMO Gigabit Indoor/Outdoor Access Point**

A dedicated high-power amplifier and professional antennas along with the latest generation 802.11ac Wave 2 MU-MIMO technology, ensure superior Wi-Fi performance and long-range coverage over 2.4GHz and 5GHz wireless bands. 802.11k and 802.11v help client select access point automatically with the best signal to facilitate seamless transitions when move.  
**TPL 831475** (831475)

**A AX1800 Ceiling Mount WiFi 6 Access Point**

With WiFi 6 technology, it provides faster speeds, less lag, and higher capacity. The advanced functions including Omada Mesh, Seamless Roaming, MU-MIMO, Captive Portal further boost network security, efficiency, and coverage.  
**TPL EAP610** (831378)

**B AX1800 Ceiling Mount WiFi 6 Access Point**

OFDMA and MU-MIMO increase network capacity by up to 4x versus Wi-Fi 5 (802.11ac) in high-density environments to connect more devices simultaneously. Leverage multi-user capabilities and upgrade your business like never before. The Omada Wi-Fi 6 Access Point features the latest 802.11ax technologies like 1024 QAM and Long OFDM Symbol, which allows the EAP to boost overall speeds up to 1775 Mbps. Limited lifetime warranty. Sold by each. White  
**TPL EAP620HD** (831471)

**C AX3600 Wireless Dual Band Multi-Gigabit Ceiling Mount Access Point**

OFDMA and Uplink & Downlink MU-MIMO increase network capacity by up to 4x versus Wi-Fi 5 (802.11ac) in high-density environments to connect more devices simultaneously. Features the latest 802.11ax technologies like 1024 QAM and Long OFDM Symbol, which allows the EAP to boost overall speeds up to 3550 Mbps.  
**TPL EAP660HD** (831470)

**D AC1350 Wireless MU-MIMO Gigabit Ceiling Mount Access Point**

Outfitted with the latest 802.11ac Wave 2 MU-MIMO technology, the EAP225 easily delivers dual-band Wi-Fi speeds of up to 1350 Mbps to multiple devices at the same time. Omada Software Defined Networking (SDN) platform integrates network devices including access points, switches and gateways.  
**TPL EAP225V3** (831474)

**E AC1750 Wireless MU-MIMO Gigabit Ceiling Mount Access Point**

QCA enterprise-class chipsets, dedicated high-power amplifier, and professional antenna along with the latest generation 802.11ac Wave 2 MU-MIMO technology ensure superior 1750 Mbps Wi-Fi speeds and long-range coverage over 2.4GHz and 5GHz wireless bands. 802.11k/802.11v seamless roaming switches clients automatically to the access point with the optimal signal with a seamless transition when moving.  
**TPL EAP245V3** (831473)

**F AC1750 Wireless MU-MIMO Gigabit Ceiling Mount Access Point**

Fast Dual-Band Wi-Fi: Simultaneous 450 Mbps on 2.4 GHz and 1300 Mbps on 5 GHz totals 1750 Mbps Wi-Fi speeds. High-Density Connectivity: MU-MIMO, Load Balance, and professional antennas improve capacity in high-density environments to connect more devices simultaneously. Integrated into Omada SDN: Supports Zero-Touch Provisioning (ZTP)\*, Centralized Cloud Management, and Intelligent Monitoring. Seamless Roaming. PoE Support: Supports both standard 802.3af/at and Passive PoE (PoE adapter included) for flexible installations.  
**TPL EAP265HD** (831472)

**G N300 Wireless N Outdoor Access Point**

Up to 300Mbps Wi-Fi with 2x2 MIMO technology. High transmission power and high gain antennas provide a long-range coverage area. Durable, weatherproof enclosure to withstand fair and foul weather. Passive PoE(Power over Ethernet) support and simple mounting design allow for flexible deployment and convenient installation. Supports management VLAN for an enhanced network management.  
**TPL 831476** (831476)

## A 48V Passive PoE Adapter

Use the passive PoE adapter TL-POE4824G to simultaneously supply power and transmit data to a passive PoE device. TL-POE4824G offers a convenient wall-mounting brackets to be easily installed on a wall. TL-POE4824G is recommended to offer power supply to TP-Link's passive PoE products which as follows. Powers TP-Link products that support 48V passive PoE. White.

**TPL TLPOE4824G** (831564)



## B PoE++ Injector

Fully complies with IEEE 802.3af/at standards with up to 60 W power supply. It can easily expand your network to where there are no power line or outlet, where you wish to fix devices such as PTZ IP Cameras, LED, etc. 2 Gigabit ports ensure faster transmission. Complies with IEEE 802.3af/at standards, supplies up to 60 W. Black.

**TPL TL-POE170S** (831370)



## C PoE+ Injector

Fully complies with IEEE 802.3af/at standards, and can work with all IEEE 802.3af/at PoE compliant PDs (Powered Devices) or PoE Receiver Adapters, such as TP-Link's TL-POE10R, or other equivalent product, to expand your network to where there are no power line or outlet, where you wish to fix device such as AP, IP Camera or IP Phone, etc. Black.

**TPL TL-POE160S** (831561)

## D PoE Injector

The PoE Injector TL-POE150S fully complies with IEEE 802.3af standard, and can work with all IEEE 802.3af PoE compliant PDs (Powered Devices) or PoE Receiver Adapters, such as TP-LINK's TL-POE10R, or other equivalent product, to expand your network to where there are no power line or outlet, where you wish to fix device such as AP, IP Camera or IP Phone, etc. Black.

**TPL TL-POE150S** (831562)

A

B

## E AX1800 Wall Plate WiFi 6 Access Point

Meet the demands for smoother online activities and more device connections. The latest 802.11ax technologies such as 1024 QAM and Long OFDM Symbol allows the EAP to boost overall speeds up to 1775 Mbps. The latest WiFi 6 features and advanced wireless techniques guarantee higher network efficiency and lower latency. White.

**TPL EAP615WALL** (831373)



C

D



E

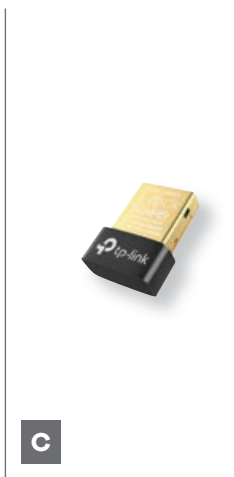

**A Archer T4U Wireless Dual Band USB Adapter**  
 1300Mbps wireless speeds (400Mbps on the 2.4GHz band and 867Mbps on the 5GHz band) with support for the next generation 802.11ac Wi-Fi standard.  
**TPL ARCHERT4U** (516286)

**B Wireless USB WiFi Adapter**  
 USB 2.0. Wireless speed up to 150 Mbps. Removable 4 dBi antenna. 1 year limited warranty.  
**TPL TL-WN722N** (831429)

**C Nano Wireless USB Bluetooth Adapter**  
 Provides stable and convenient communication between Bluetooth devices and your PC or laptop. 2-year limited warranty.  
**TPL UB400** (831434) USB Bluetooth 4.0  
**TPL UB500** (831433) USB Bluetooth 5.0

**D Archer T4U Plus AC1300 Wireless USB Adapter**  
 Connects to USB 3.1 Gen 1 Type-A port. Designed to deliver up to 1267 Mb/s over the 2.4 GHz and 5 GHz frequencies. 2-year limited warranty.  
**TPL 831421** (831421)



**E Archer T3U Plus AC1300 Wireless Dual-Band USB Adapter**  
 Connect to USB 3.1 Gen 1 Type-A port. Delivers exceptional signal reception with speeds of up to 1267 Mb/s over the 2.4 and 5 GHz signal bands. 2-year limited warranty.  
**TPL ARCHERT3U** (831423) T3U mini  
**TPL 831422** (831422) T3U Plus

**F Mini Wireless USB WiFi Adapter**  
 USB 2.0. Features SoftAP Mode, one-button security setup, easy-to-use configuration software. 2-year limited warranty.  
**TPL TL-WN725N** (831428) 150Mbps  
**TPL TL-WN823N** (831427) 300 Mbps

**G Archer T2U Plus AC600 High Gain Dual-Band Wi-Fi USB Adapter**  
 Connects to USB 2.0 port. Delivering speeds of up to 200 Mb/s on the 2.4 GHz band and 433 Mb/s on 5 GHz. 2-year limited warranty.  
**TPL 831426** (831426) T2U nano  
**TPL 831425** (831425) T2U  
**TPL 831424** (831424) T2U Plus

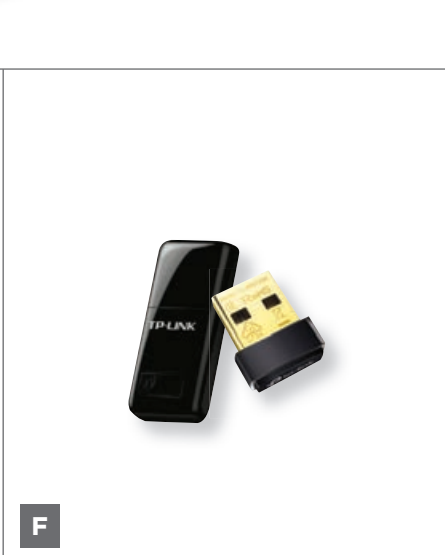



**A Archer TX3000E WiFi PCIe Card  
Wireless Adapter**

Dual-channel 802.11ax Wi-Fi 6 connection. Reach speeds up to 574 Mb/s over the 2.4 GHz channel and up to 2402 Mb/s on the 5 GHz channel using compatible routers. 3-year limited warranty.  
**TPL 831418** (831418)



**A**

**B Archer TX50E AX3000 Wi-Fi 6 and Bluetooth 5.0 PCIe Adapter**

Two powerful 5 dBi high-gain antennas and Wi-Fi 6 (802.11ax) support, this adapter can transfer up to 2402 Mb/s over the 5 GHz frequency and 867 Mb/s over the 2.4 GHz signal for a total throughput of 2976 Mb/s. 2-year limited warranty.  
**TPL 831419** (831419)

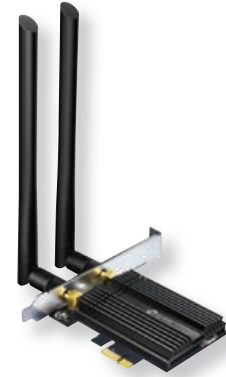

**B**

**C Archer T4E AC1200 Wireless Dual Band PCI Express Adapter**

Supports the advanced Wi-Fi standard of IEEE 802.11ac. Up to 1200 Mbps Wi-Fi speeds (867 Mbps on 5 GHz band and 300 Mbps on 2.4 GHz band). Beamforming – Wi-Fi signals are strengthened towards certain direction where client exists. 2-year limited warranty.  
**TPL ARCHERT4E** (831439)



**C**

**D Archer T2E AC600 Wireless Dual Band PCI Express Adapter**

Wi-Fi speeds up to 600 Mbps (433 Mbps on the 5 GHz band and 200 Mbps on the 2.4 GHz band). Priced in charge MU-MIMO. 2-year limited warranty.  
**TPL ARCHERT2E** (831440)



**D**

**E Archer T5E AC1200 Wi-Fi & Bluetooth 4.2 PCIe Adapter**

Two powerful external antennas, this dual-band adapter can reach speeds of up to 300 Mb/s over the 2.4 GHz band and up to 867 Mb/s over the 5 GHz frequency when connected to compatible 8011.ac devices. 2-year limited warranty.  
**TPL ARCHERT5E** (831435)

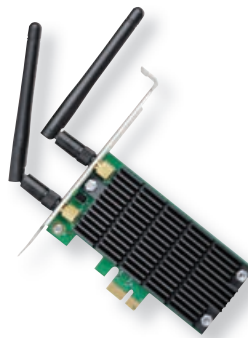

**E**

**F TL-WN881ND Wireless-N300 PCI Express Adapter**

Wireless N speeds up to 300 Mbps are ideal for video streaming, online gaming and Internet calls. MIMO technology provides greater signal penetration strength and wider wireless coverage for improved performance and stability. 2-year limited warranty.  
**TPL TL-WN881ND** (831441)



**F**

**G UE306 USB 3.0 Type-A to Gigabit Ethernet Network Adapter**

Give your laptop, computer, and other USB web devices access to wired network connections. Ideal for devices without a built-in RJ45 Ethernet port. 2-year limited warranty.  
**TPL UE306** (831667)



**G**

**H UE300C Ethernet USB Adapter**

Give your laptop, tablet, computer and other USB powered web devices the access to wired network connection. Supports network speeds up to 1000 Mbps. 2-year limited warranty.  
**TPL UE300C** (831668) USB TYPE-C  
**TPL UE300** (831669) USB 3.0



**H**



**G**

**H**



**A**



**B**

**A Archer AX23 WiFi Router**

Transfer HD movies in 10 seconds. WiFi 6's 1024-QAM improves encoding efficiency by 25% while the improved symbol rate boosts data rate by 11%. Enjoy smooth gaming, video streaming, and live feeds simultaneously. 2-year limited warranty.

**TPL ARCHERAX23** (831372)

**B Archer GX90 Router**

3 distinct bands with combined speed up to warp 6579 Mbps. A fully featured gaming band equipped with 4T4R and HE160 technology, offering all your gaming rigs at top speed 4804 Mbps and preventing interference from other devices. 2-year limited warranty.

**TPL ARCHERGX90** (831402)

**C Archer AX90 Router**

AX 6600 Mbps tri-band Wi-Fi 6 router. 1.5 GHz Quad-Core CPU provides a smoother and truly immersive streaming or gaming experience while the five Ethernet ports let you create fast, reliable wired connections. 2-year limited warranty.

**TPL ARCHERAX90** (831403)



**C**



**D**

**D Archer AX6000 Router**

Boasting throughput speeds up to 6,000 Mb/s, the Archer AX6000 Wi-Fi Router from TP-Link features support for Wi-Fi 6 (802.11ax), a Wi-Fi standard that employs wireless technologies such as OFDMA (Orthogonal Frequency-Division Multiple Access) and multi-user MIMO (Multiple Input and Multiple Output). 2-year limited warranty.

**TPL 831404** (831404)

**E Archer AX73 Router**

With this high-performance 802.11ax dual-band router, you can transfer data wirelessly at up to 5378 Mb/s over the 2.4 GHz and 5 GHz frequencies for smooth 4K video streaming, online games, video chats, and more. 2-year limited warranty.

**TPL ARCHERAX73** (831405)



**E**



**F**

**F Archer AX55 Router**

5 GHz with 160 MHz channel support doubles the bandwidth, enabling 8K video without lag. Enjoy smooth gaming, video streaming, and live feed simultaneously. 2-year limited warranty.

**TPL ARCHERAX55** (831406)

**G Archer AX50 Router**

Featuring a 160 MHz bandwidth and 1024-QAM, and true gigabit speeds of up to 3 Gbps. Enjoy faster streaming and gaming like never before. Powered by Intel, this full-featured Wi-Fi 6 AX3000 router pairs perfectly with new Intel Wi-Fi 6 Gig+ PCs and laptops. 2-year limited warranty.

**TPL ARCHERAX50** (831407)



**G**



**H**

**H Archer AX20 Router**

With this 802.11ax dual-band router, you can transfer data wirelessly at up to 1775 Mb/s over the 2.4 GHz and 5 GHz frequencies for smooth 4K video streaming, online games, video chats, and more. Four Gigabit Ethernet ports are available for high-speed wired connections to computers, video game consoles. 2-year limited warranty.

**TPL ARCHERAX20** (831408)

**I Archer Ax10 Router**

This router supports the Wi-Fi 6 (802.11ax) protocol for wireless network data transfer speeds of up to 1501 Mb/s. That speed is split between dual band technology, with up to 1201 Mb/s on the 5 GHz band and up to 300 Mb/s on the 2.4 GHz band. 2-year limited warranty.

**TPL ARCHERAX10** (831409)



**I**



**A Archer C80 Router**

Total speeds up to 1900 Mbps. Handle simple tasks like sending e-mails or web browsing on the 2.4 GHz band and bandwidth-intensive tasks like online gaming or 4K/8K UHD streaming on the 5 GHz band—all lag-free. 2-year limited warranty.

**TPL ARCHERC80** (831410)



**A**



**B**

**B Archer A6 V3 Router**

Featuring four powerful external antennas that work alongside an internal one, this dual-band 802.11ac Wi-Fi router can transfer up to 1167 Mb/s over the 2.4 and 5 GHz frequencies with compatible devices. 2-year limited warranty.

**TPL ARCHERA6V3** (831411)

**C Archer C50 V3 Router**

Delivers a combined wireless data transfer rate of up to 1.2 Gbps. With 300 Mbps over the 2.4 GHz band and 867 Mbps wireless speeds over the crystal clear 5 GHz band. 2-year limited warranty.

**TPL 831412** (831412)

**D 450Mbps Wireless N Router**

450Mbps wireless speed ideal for interruption sensitive applications like HD video streaming. Supports 3 modes: Router, Range Extender and Access Point modes. Easy wireless security encryption at a push of WPS button. Bandwidth Control: assigns your preferred devices with more bandwidth.

**TPL TL-WR940N** (831413)



**C**



**D**

**E TL-WR841N Router**

The TL-WR841N Wireless N 10/100 Mb Router provides wired and wireless network connection with a 4-port switch that allows wireless access to multiple devices in your home without necessarily having to run unsightly wires. It is backward compatible with 802.11b and g and, besides its 300 Mb/s speed, 802.11n provides strong performance on the 2.4 GHz frequency band at long distances. 2-year limited warranty.

Sold by each. Black  
**TPL TL-WR841N** (831414)

**F 450Mbps High Power Wireless N Router**

Superior Range – High power amplifiers and high-gain antennas provide enhanced wireless range up to 10,000 sq ft. Wall-Penetrating Wi-Fi – Enhanced Wi-Fi signal cuts through walls and obstacles, eliminating dead zones. Supports 3 modes: Router, Range Extender and Access Point modes. 450Mbps Wireless Speed – Ideal for video streaming, online gaming and VoIP.

**TPL TL-WR941HP** (831415)



**E**



**F**

**G TL-WR902AC Portable Router**

Dual Band WiFi AC750. developed for travel : small and light. Mini WiFi router to connect to an Internet source (wired or WiFi) in order to broadcast it in WiFi. Features Router, Hotspot, WiFi Repeater, Client and Access Point modes. 2-year limited warranty.

**TPL TL-WR902AC** (831416)

**H TL-WR802N Nano Router**

Designed for use with tablets, smart phones, handheld game consoles and other portable electronic wireless devices. This router, which can be powered by an external power adapter or USB connection to a computer, can conveniently connect to the Internet and share the connection around an average sized room at 300 Mbps. 2-year limited warranty.

**TPL TL-WR802N** (831417)



**G**



**H**



## DECO WHOLE-HOME MESH WI-FI SYSTEM

Deco units work together to form one unified network with a single network name. Your phone or tablet automatically connects to the fastest Deco as you move through your home. The switching takes less than 0.3 second and is smooth and unnoticeable, creating a truly seamless online experience.



**A**



**B**



**C**



**D**



**E**



**F**



**G**



**H**

### A Deco E4 AC1200 Mesh Wi-Fi System

867 Mbps + 300 Mbps. 2 x 10/100 Mbps ports. 2 internal antennas. Connect up to 100 devices. Box of 3.  
**TPL 831397** (831397)

### B Deco M4 AC1200 Mesh Wi-Fi System

867 Mbps + 300 Mbps. 2 Gigabit ports. 2 internal antennas. Connect up to 100 devices.  
**TPL 831395** (831395) box 2  
**TPL 831393** (831393) box 3

### C Deco M5 AC1300 Mesh Wi-Fi System

867 Mbps + 400 Mbps. 2 Gigabit ports. 4 internal antennas. Connect over 100 devices.  
**TPL 831390** (831390) by each  
**TPL 831389** (831389) box 2  
**TPL 831388** (831388) box 3

### D Deco M9 Plus AC2200 Mesh Wi-Fi System

2x 867 Mbps + 400 Mbps. 1 USB 2.0 port. 2 Gigabit ports. 8 internal antennas. Connect over 100 devices.  
**TPL 831392** (831392) box 2  
**TPL 831391** (831391) box 3

### E Deco X20 AX1800 Mesh Wi-Fi 6 System

1201 Mbps + 574 Mbps. 2 Gigabit ports. 4 antennas. Connects 150 devices.  
**TPL 831387** (831387) by each  
**TPL 831386** (831386) box 2  
**TPL 831385** (831385) box 3

### F Deco X50 AX3000 Mesh WiFi 6 System

2402 Mbps + 574 Mbps. 3 Gigabit ports. 4 streams, less lag. Connects over 150 devices. TP-Link HomeShield.  
**TPL 831366** (831366) box 2  
**TPL 831369** (831369) box 3

### G Deco X60 AX3000 Mesh Wi-Fi 6 System

4804 Mbps + 1201 Mbps + 574 Mbps. 1 2.5 Gbps port +1 Gigabit Port. 6 antennas + 2 Smart Array antennas. Connects up to 200 devices.  
**TPL 831384** (831384) by each  
**TPL 831383** (831383) box 2  
**TPL 831382** (831382) box 3

### H Deco X90 AX6600 Mesh Wi-Fi System

4804 Mbps + 1201 Mbps + 574 Mbps. 1 2.5 Gbps port +1 Gigabit Port. 6 antennas + 2 Smart Array antennas. Connects 200 devices. Box of 2  
**TPL 831381** (831381)



## A RE600X AX1800 Wi-Fi 6 Range Extender

1201 Mbps + 574 Mbps. 1 Gigabit port. Pairs with your TP-Link OneMesh compatible router with the touch of the WPS button to create a unified mesh network that operates using a single network ID (SSID), providing uninterrupted 4K video streaming, online gaming.

**TPL RE600X** (831376)

## B RE500X WiFi Range Extender

This compact 802.11ax range extender works with almost any brand and model router to deliver up to 1500 Mb/s throughput over the 2.4 GHz and 5 GHz frequencies.

**TPL RE500X** (831377)

## C RE550 WiFi Range Extender

Designed to work with almost any router, this dual-band 802.11ac Wi-Fi range extender can be integrated into your network at the push of a button and delivers up to 1900 Mb/s throughput over the 2.4 GHz and 5 GHz frequencies.

**TPL RE550** (831451)

## D RE450 WiFi Range Extender

Operates on both the 2.4 GHz and 5 GHz frequency and supports the 802.11ac networking standard offering a total bandwidth of up to 1750 Mbps. These enhanced data transfer rates make it easy to use this adapter to stream HD multimedia content, game online, download large files, and much more.

**TPL RE450** (831452)

## E RE315 WiFi Range Extender

Designed to work with OneMesh-compatible networks, this 802.11ac dual-band range extender transfers data at up to 1167 Mb/s over the 2.4 GHz and 5 GHz frequencies.

**TPL RE315** (831453)

## F RE300 WiFi Range Extender

This dual-range extender plugs into any AC wall outlet and boosts the range of an existing Wi-Fi router by piggybacking onto its signal. The extender can create a unified OneMesh network if it's connected to a OneMesh-enabled router. A signal indicator lets you know if the extender is in range of your router.

**TPL RE300** (831454)

## G RE305 WiFi Range Extender

This range extender supports the 802.11ac Wi-Fi network standard and operates on both the 2.4 GHz and 5 GHz frequencies offering a total Wi-Fi throughput of up to 1167 Mbps.

**TPL RE305** (831455)



A



B



C



D



E



F



G



**A**



**B**



**C**



**D**



**E**



**F**



**G**



**A RE220 WiFi Range Extender**

Capable of up to 750 Mb/s of total Wi-Fi data throughput, the AC750 wireless extender plugs into a standard wall outlet, and it comes equipped with three internal antennas and a Fast Ethernet port.

**TPL RE220** (831456)

**B RE215 WiFi Range Extender**

Designed to work with OneMesh-compatible networks, this 802.11ac dual-band range extender transfers data at up to 733 Mb/s over the 2.4 GHz and 5 GHz frequencies.

**TPL RE215** (831457)

**C 300Mbps Universal WiFi N Range Extender**

Range extender mode boosts wireless signal to previously unreachable or hard-to-wire areas flawlessly. Miniature size and wall-mounted design make it easy to deploy and move flexibly. Ethernet port allows the Extender to function as a wireless adapter to connect wired devices. Two internal antennas. One Ethernet port. Ethernet cable included.

**TPL TL-WA850RE** (514091)

**D AV2000 Ethernet Adapter Kit**

Capable of supporting data transfer rates of up to 2000 Mbps. In addition to enhanced data transfer rates, Support 2x2 MIMO technology which supports multiple data pathways giving multiple devices each their own direct connection to the network.

**TPL 831461** (831461)

**E WiFi Extender Kit**

The kit includes two homeplug av2 compliant modules and is designed to reliably transmit up to 1 GB/s of data over 1,000 feet using wires from your home.

**TPL 831459** (831459)

**F Ethernet Adapter and WiFi Extender Kit**

This kit includes two HomePlug AV2-compliant modules that are designed to reliably transfer up to 1 Gb/s of data across up to 1000' using your home's electrical wiring.

**TPL 831458** (831458)

**G AV1000 Ethernet Adapter Kit**

This kit includes two HomePlug AV2-compliant modules that plug into 3-prong U.S. wall outlets to reliably transfer data up to 984.3' using your home's electrical wiring. Setup is easy. Simply connect one module to your router and the other to a remote device through using their respective Gigabit Ethernet ports.

**TPL 831462** (831462)

**H AV1000 Ethernet Adapter Kit**

Using advanced HomePlug AV2 technology, TL-PA7017 KIT ensures a stable and high-speed wired connection, providing data transmissions of up to 1000 Mbps over the electrical wiring for ranges up to 300 meters. Stream in HD, game online and download large files without interruption thanks to reliable powerline links. This makes the TL-PA7017 KIT the perfect home entertainment companion. 2-year limited warranty.

Sold by each. White  
**TPL 831463** (831463)

## A USB-C Wall Charger

USB-C Power Delivery wall charger able to fast charge your USB-C phone, tablet, or laptop that requires up to 60W. This USB-C wall charger is compatible with a vast array of USB Type-C devices such as the MacBook Pro 13-inch, XPS 13, Surface Book 2 and Lenovo ThinkPad X1 Carbon. A 6-foot (2 meter) USB-C to USB-C cable is included. 2-year limited warranty.

**STC WCH1CBK** (831735) black  
**STC WCH1C** (831999) white



**A** StarTech.com

## B USB-C Wall Power Adapter

90W USB-C wall power adapter. 1-year limited warranty. Black.  
**AXI 832390** (832390)



**B** AXIOM

## C USB and USB-C Power Charger

5 ports. 4 ports USB Type A and 1 port USB Type C. Up to 111W input. Lightweight and easy installation. Black.  
**CBB CAC-1903US** (832447)



**C** Club  
 Superior Quality



**D** Club  
 Superior Quality



**E** nimble

## D Travel Charger

GAN technology. Equipped with 3 USB Type-C ports and 1 Type-A port. 132W of output power in total. Compatible with multiple devices. Lightweight and convenient to use. Black.

**CBB CAC1906** (832448)

## E Wally Pro Portable 63W USB-C and USB-A

All-in-one wall charger with built-in 10,000mAh battery for fast-charging laptops and more on-the-go. 72.5% recycled content.

**NMB 832464** (832464)

## F 3 Ports USB-C Charging Hub

This 72W USB-C charging station works with USB-C PD devices. Works as a laptop replacement charger supporting USB-C PD 3.0, with an additional 12W output shared across 3 USB-A fast charge ports supporting BC 1.2. USB-A Charging. 2-year limited warranty. Black.  
**STC DCH1C3A** (831736)



**F** tp-link

## G 4 Port USB-C Hub

The USB-C 3.1 Gen 2 hub offers 10 Gbps, supporting greater bus bandwidth to connected devices and faster data transfer speeds. This self-powered 4-Port USB-C hub plugs into the USB Type-C or Thunderbolt 3 port on your device, adding one USB-C port and three USB-A ports, so you can quickly connect more USB devices. 2-year limited warranty. Grey.  
**STC HB31C3A1CS** (832102)



**G** StarTech.com

## H USB-C Multiport Hub

The versatile USB-C 12-in-1 hub maximizes connectivity so that users can address everyday computing needs ranging from memory to data transfer to multimedia. 3-year limited warranty. Black.  
**AXI 832389** (832389)



**H** AXIOM

## I Thunderbolt 3 USB-C Cable

Faster data transfers when connected to Thunderbolt devices. USB-C compatible. Full 4K video. Versatile power delivery. 2-year limited warranty.  
**STC TBLT3MM1M** (831737) 3 ft. (black)  
**STC TBLT3MM1M** (831738) 6.6 ft. (black)  
**STC TBLT3MM2MW** (831877) 6.6 ft. (white)



**I** tp-link

## J DisplayPort M/M Cable

The cable supports high resolutions of up to 4K x 2K (4096 x 2160) at 60Hz with a maximum HBR2 bandwidth of 21.6 Gbps. The cable also supports Multi-Stream (MST) for daisy chaining multiple monitors and provides optional audio support. Limited lifetime warranty. Black.  
**STC 832124** (832124) 3 ft.  
**STC 832126** (832126) 10 ft.  
**STC 832125** (832125) 15 ft.



**J** StarTech.com

## K DisplayPort M/M Cable - 8K

Supports resolutions up to 8K (7680 x 4320) at 60Hz. High Bit Rate 3 (HBR3) Bandwidths of 32.4 Gbps supporting the latest in industry standards. Limited lifetime warranty. Black/Grey.  
**STC DP14VMM1M** (832127) 3 ft.  
**STC DP14VMM2M** (832128) 10 ft.  
**STC DP14VMM3M** (832129) 15 ft.



**K** StarTech.com

 <p><b>A</b> Targus</p> 	 <p><b>B</b> Targus</p> 	<p><b>A Universal USB-C DV4K Docking Station</b> Dock with AC power adapter. Dual displays. Supports Dual DisplayPort and HDMI monitors. Thunderbolt 3 compatible. Produces clear images at resolutions up to 4096 x 2160 60 Hz. 4 x USB 3.0 5Gbps ports, 1 x USB-C device port, 2 x HDMI, 2 x DP, 1 x Gigabit Ethernet port. AC adapter. Includes 1-meter USB-C to C host cable (detachable). 6.75 x 1.5 x 3.5 in. Black. <b>TRG DOCK180USZ</b> (576108)</p> <p><b>B Universal USB-C DV4K Docking Station</b> For dual displays. Supports Dual DisplayPort and HDMI monitors. Thunderbolt 3 compatible. Produces clear images at resolutions up to 4096 x 2160 60 Hz. 4 x USB 3.0 5 Gbps ports, 1 x USB-C device port, 2 x HDMI, 1 x Gigabit Ethernet port. AC adapter. Includes 1-meter USB-C to C host cable (detachable). Fits all Lenovo Notebooks. 6.8 x 1.3 x 3.0 in. Black. <b>TRG DOCK190USZ</b> (578856)</p>
 <p><b>C</b> ASUS</p>  	 <p><b>D</b> Targus</p>  	<p><b>C USB-C Docking Station</b> Connect up to three monitors; or one 5K display, or dual 4K displays. Provide up to 120W power. Front: 1x audio combo jack, 1x Thunderbolt 3 USB-C, 1x USB 3.2 Type-C, 2x USB 3.2 Type-A, 1x Smart Card reader. Back : 2 prises DisplayPort, 1x USB 3.2 type-A, 1x HDMI 2.0, 1x VGA, Ethernet RJ45. Black. <b>ASU 828424</b> (828424)</p> <p><b>D DV4K Universal USB-C Docking Station</b> Universal USB-C DV4K Docking Station with 100W Power. Designed to support and power a wide variety of USB-C laptops and operating systems. Enjoy sharp 4K video while supporting a connection with up to two monitors using its two HDMI and two DisplayPort connections. 3-year limited warranty. Black. <b>TRG DOCK182USZ</b> (828971)</p>
 <p><b>E</b> StarTech.com</p> 	 <p><b>F</b> tp-link</p>  	<p><b>E HDMI USB 3.0 Docking Station</b> Combines three USB 3.0 ports, headphone, microphone audio connectors, a Gigabit Ethernet RJ45 port, into a single docking station for maximum productivity. This universal laptop docking station features HDMI, DVI and VGA external monitor outputs. The integrated RJ45 Ethernet port supports speeds of 10/100/1000 Mbps, giving you an instant connection to a wired network. 3-year limited warranty. Black. <b>STC 829149</b> (829149)</p> <p><b>F HDMI USB-C Docking Station</b> Connect two HDMI monitors or DVI monitors using one USB-C cable, with no setup of display drivers required. The USB-C dock provides 60W charging power, and five USB 3.0 ports to connect devices. 3-year limited warranty. Black. <b>STC 831733</b> (831733) HDMI <b>STC DK30CH2DEP</b> (831734) HDMI 4K</p>
 <p><b>G</b> StarTech.com</p> 	 <p><b>H</b> Club</p>  	<p><b>G USB-C Multiport Adapter</b> Compatible with MacBook Pro, Dell XPS, or other USB-C laptop. The USB-C multiport adapter provides 4K HDMI video output, a USB-C port (data/power), two USB 3.0 Type-A ports, a Gigabit Ethernet port and an SD card reader slot, all through one connection to your laptop's USB-C or Thunderbolt 3 port. 3-year limited warranty. Grey. <b>STC 832000</b> (832000)</p> <p><b>H Power Delivery Charging Dock</b> One USB 3.2 Gen1 Type C Data port. HDMI™ 4K 30 Hz. VGA 1920x1200 60Hz. Triple Display support. Black. <b>CBB CSV1564W65</b> (832532) 65 W <b>CBB 832530</b> (832530) 100W</p>
 <p><b>I</b> Club</p>  	 <p><b>J</b> Club</p>  	<p><b>I Power Delivery Charging Dock</b> 2 USB-A 10G, 1 Type-C 10G, 1 USB-A 5G, 1 USB-A smart charging port for quick charging. 1 Gigabit Ethernet for super fast Ethernet. 2 audio ports. 120W. Silver. <b>CBB CSV-1568</b> (832531)</p> <p><b>J Docking Station</b> USB 3.2 Gen 1 Dual Display 4K 60Hz. Fully USB-C compatible with USB-C cable included in the box. Supports Gigabit Ethernet (10/ 100/ 1000Mbps). Audio: 2 x 3.5 mm jack for headphone and microphone. Black. <b>CBB CSV-1460</b> (832533)</p>



## A CP350SLG Uninterruptible Power Supply

Safeguards electronic devices from blackouts, surges, spikes and other power abnormalities. 350 VA/255 watts capacity. 6 outlets, EMI/RFI filters. 2 min. runtime at full load. 8-hour recharge time. 810 joules. Black.

**CYP CP350SLG** (204834)

## B CP750LCD Uninterruptible Power Supply

Desktop size. 750 VA/420 W output. Multifunction diagnostic LCD. 3 minutes runtime at full load. 8-hour recharge time. 8 outlets, USB port and phone line protection. EMI/RFI filters. 890 joules. Black.

**CYP CP750LCD** (209338)

## C Uninterruptible Power Supply

Provides battery backup and surge protection for lightning-induced surges and other power events that can damage electronic equipment. This unit delivers enough battery backup to power connected electronics through utility power failure and enough runtime to perform a proper shutdown to protect against the loss of data and damage to valuable electronics during longer outages. 3-year limited warranty. Black.

**CYP ST425** (829884) ST425 - 120 VA

**CYP ST625U** (829885) ST625U - 620 VA

## D SL700U Uninterruptible Power Supply

Provides battery backup (700VA / 370W) and surge protection. This unit delivers enough battery backup to power connected electronics to perform a graceful shutdown to protect against the loss of data and damage to valuable electronics during longer outages. It also features 2 USB charging ports with 2.4A shared between them. 3-year limited warranty. 100,000\$ connected equipment guarantee.

**CYP SL700U** (829886)

## E CP1000AVRLCD Power Supply

A mini-tower uninterruptible power supply (UPS) with line interactive topology, the Intelligent LCD CP1000AVRLCD provides battery backup (1000VA/600W) and surge protection. The CP1000AVRLCD uses Automatic Voltage Regulation (AVR) to correct minor power fluctuations without switching to battery power, which extends battery life. 3-year limited warranty. 350,000\$ connected equipment guarantee. Black.

**CYP 829887** (829887)

## F CP1500PFCLCD Power Supply

A mini-tower uninterruptible power supply (UPS) with line interactive topology, the Intelligent LCD CP1500PFCLCD provides battery backup (1500VA/1000W) and surge protection. The CP1500PFCLCD uses Automatic Voltage Regulation (AVR) to correct minor power fluctuations without switching to battery power, which extends battery life. 3-year limited warranty. 500,000\$ connected equipment guarantee. Black.

**CYP 829888** (829888)

## G UPS 12V Replacement Battery

The RB1290 UPS Replacement Battery Cartridge restores life to UPS systems that have weak or completely depleted internal batteries. The RB1290 contains one 12V/9AH battery, certified to meet or exceed original manufacturer specifications. This leak-proof, sealed lead-acid battery never requires replacement fluid. Supplies high surge currents and provides robust power-to-weight ratios. 1.5-year limited warranty.

**CYP RB1290** (829889) by each

**CYP RB1290X2** (829890) pkg 2

CyberPower®



A



B



C



D



E



F



G

# Energizer®



	ULTIMATE LITHIUM™	MAX™	RECHARGE POWER PLUS	INDUSTRIAL
<b>Key Feature</b>	#1 Longest Lasting AA battery	Our #1 Longest Lasting MAX™ (AA/AAA)	World's first AA/AAA rechargeable battery made with 4% recycled batteries. Batteries come pre-charged.	Trusted by working professionals – has the same long lasting power and reliability of Energizer MAX®.
<b>Sizes Available</b>	AA, AAA, 9V	AA, AAA, C, D, 9V	AA, AAA	AA, AAA, C, D, 9V, Lantern
<b>Devices most frequently used in</b>	HOME AUTOMATION            HANDHELD GAMES            CAMPING LANTERN	REMOTE CONTROL            FLASHLIGHT            TOYS	REMOTE CONTROL TOY            WIRELESS GAME CONTROLLER            DIGITAL AUDIO	REMOTE CONTROL            FLASHLIGHT            TOYS
<b>Shelf/Usable Life (lasts up to)</b>	AA/AAA = 20 years	AA/AAA/C/D = 10 years	AA/AAA = 5 years	AA/AAA/C/D = 10 years
	9V = 10 years	AAAA/N/9V/6V = 5 years		9V/Lantern = 5 years
<b>Operating temperature</b>	Ideal for usage in extreme temperature: -40°C to +60°C	Operates well at a wide range of temperatures: -18° C to 55° C	Charging/Discharging: 0° C to 50° C	Operates well at a wide range of temperatures: -18° C to 55° C
<b>Battery Weight</b>	33% lighter than alkaline batteries 0.3 oz - 1.2 oz	Varies by battery type 0.4 oz - 23.5 oz	Varies by battery type 0.4 oz - 1.1 oz	Varies by battery type 0.4 oz - 23.5 oz

## SPECIALTY BATTERIES



Energizer® offers a full range of long-lasting miniature batteries. Whether for your watch, camera, glucose monitor, pedometer, remote control or other small devices, you can select from our wide selection of miniature options.



## PRO CHARGER

The Energizer® brand's first charger with sound charge status notification. Has an auto-shut off mode, comes with an LED charge status indicator and a 4 position charger that can charge AA and AAA NiMH batteries.

Visit [www.energizer.ca](http://www.energizer.ca) to see more details on our full range of household and specialty batteries, chargers and lights.

## A Ultimate™ Lithium Batteries

EVE L522BP (349456) 1 x 9V  
 EVE L92SBP-4 (513853) 4 x AAA  
 EVE L92SBP-8 (456731) 8 x AAA  
 EVE L91SBP4 (517151) 4 x AA  
 EVE L91BP-8 (823681) 8 x AA

Energizer



A



B

## B Max Alkaline Batteries

6V  
 EVE529-1 (594226) by each  
 9V  
 EVE 522BP2 (587956) pkg 2  
 EVE522BP4 (611475) pkg 4  
 AAAA, 1.5V  
 EVE E96BP2 (571083) pkg 2  
 AAA  
 EVE E92BP4 (367672) pkg 4  
 EVEE92MP8 (587816) pkg 8  
 EVEE92BP12 (183269) pkg 12  
 EVE E92LP-16 (570986) pkg 16  
 AA  
 EVE E91BP4 (357293) pkg 4  
 EVE E91MP8 (587642) pkg 8  
 EVEE91BW12EM (587659) pkg 12  
 EVE E91BP-24 (570978) pkg 24



C



D

## C

## C Industrial Alkaline Batteries

EVE EN22 (183020) 12 x 9V  
 EVE EN92 (182998) 24 x AAA  
 EVE EN91 (182980) 24 x AA  
 EVE EN93 (183004) 12 x C  
 EVE EN95 (183012) 12 x D



E

F



## D Electronic Device Batteries

1.5 V  
 EVE A76BPZ (112532) A76  
 EVE 377BPZ (174656) 377  
 EVE 357BPZ-3N (183228) 3 x 357  
 EVE 389BPZ (829144) 390/389  
 3 V - Lithium  
 EVE EL123APBP (611566) 123  
 EVE ECR1632BP (183277) CR1632  
 EVE 2016BP2N (183194) 2 x CR2016  
 EVE 2025BP2N (183202) 2 x CR2025  
 EVE ECR2450BP (100313) CR2450  
 EVE 2025BP-4 (823663) 4 x CR2025  
 EVE 2032BP2N (183210) 2 x CR2032  
 EVE 2032BP-4 (827664) 4 x CR2032



G



H



## E Small Device Batteries

E90/N alkaline batteries  
 EVE E90BP2 (1033687) 1.5V (pkg 2)  
 A23 lithium battery  
 EVE A23BPZ (313973) 3V (by each)

## F Recharge® PRO Battery Charger

For AA & AAA rechargeable batteries. Includes charger and 4 AA batteries.  
 EVE CHPROWB4 (275297)

## G Exceptional Value NiMH Battery Charger

Charges 2 or 4 NiMH AA or AAA batteries. Includes charger and 4 AA batteries.  
 EVE CHVCMWB-4 (133223)

## H Value Charger

Charges 2 or 4 AA/AAA NiMH rechargeable batteries. Includes charger and 2 AA batteries.  
 EVE CHVCWB2 (235986)

## I Recharge® Rechargeable Batteries

Pre-charged and ready to use.  
 EVE NH22NBP (236000) 1 x 9V  
 EVENH12BP-4 (778779) 4 x AAA  
 EVENH15BP4 (762435) 4 x AA  
 EVE NH35BP2 (236018) 2 x C  
 EVE NH50BP2 (236026) 2 x D



I



## SAVE MONEY WITH LONGER-LASTING DEVICE-SPECIFIC BATTERIES\*



Power the profitability of your business with long lasting PROCELL® batteries. Minimize the time and money spent on battery replacements so your staff can focus on other key maintenance operations.



### DURACELL® COPPERTOP® WITH POWER BOOST™

Trusted for long lasting, consistent performance.



### PROCELL® CONSTANT POWER ALKALINE BATTERIES

Specifically engineered to deliver consistent performance while lasting longer in low-drain professional devices.\*



### PROCELL® HIGH POWER LITHIUM & LITHIUM COIN BATTERIES

Designed for small professional safety, security, medical, and smart devices.



### PROCELL® INTENSE POWER ALKALINE BATTERIES

Engineered to deliver precise pulses of energy while lasting longer in high-drain professional devices.\*

## COMMITTED TO SUSTAINABILITY



PROCELL® works with Call2Recycle, the nation's largest, most reliable battery recycling program, to ensure our batteries can be responsibly recycled when they reach their end-of-life.

Visit [www.call2recycle.ca](http://www.call2recycle.ca) to learn how you can start recycling batteries.

FOR MORE INFORMATION VISIT  
[WWW.PROCELL.COM](http://WWW.PROCELL.COM)

\*vs. prior PROCELL® AA, AAA, C, D and 9V batteries  
© 2022 Duracell Industrial Operations, Inc.

## A Procell® Alkaline Intense Power Batteries

- DURPX1604 (828510) 12 x 9V
- DURPX2400 (828506) 24 x AAA
- DURPX1500 (828507) 24 x AA
- DURPX1400 (828508) 12 x C
- DURPX1300 (828509) 12 x D

**DURACELL®**



## B Procell Lithium Pills

Designed to deliver reliable and safe power in professional devices.  
3V. Package of 5.

- DURPCCR2 (829817) 1X CR2
- DURPC2016 (829815) 5 x CR2016
- DURPC2025 (829814) 5 x CR2025
- DURPC2032 (829816) 5 x CR2032

## C Procell® Alkaline Batteries

- DURPC1604BKD (340943) 12 x 9V
- DUR340968 (340968) 24 x AAA
- DUR325613 (325613) 24 x AA
- DURPC1400 (340976) 12 x C
- DURPC1300 (340984) 12 x D

**A**

**N**  
2023

**B**

**N**  
2023

## D Coppertop Alkaline Batteries

- 6 V
- DURMN908 (524165) by each
- 9V
- DURMN1604B2Z (1033612) pkg 2
- DURMN16RT4Z (1013515) pkg 4
- DURMN1604BKD (562249) box 12
- AAAA
- DURMX2500B2PK (805599) pkg 2
- AAA
- DURMN2400B4Z (1013549) pkg 4
- DURMN2400B8Z (1033646) pkg 8
- DURMN24RT12Z (1013648) pkg 12
- DURMN2400B16Z (1033745) pkg 16
- DURMN2400BKD (552968) box 24
- AA
- DURMN1500B4Z (1013531) pkg 4
- DURMN1500B8Z (1033638) pkg 8
- DURMN15RT12Z (1033620) pkg 12
- DURMN1500BKD (552976) box 24
- C
- DURMN1400B2Z (1013557) pkg 2
- DURMN14RT8Z (1033654) pkg 8
- DURMN1400BKD (552885) box 12
- D
- DURMN1300B2Z (1033661) pkg 2
- DURMN13RT8Z (1033679) pkg 8
- DURMN1300BKD (552877) box 12



**C**

**D**

## E Electronic Device Batteries

- 1.5 V
- DURD377BPK (562173) D377
- DURD303/357PK (1013630) D303/357
- DURPX76A675PK (552869) PX76A675
- 3 V
- DURDL123ABPK (562181) DL123A
- DURDL2016BPK (1033729) DL2016
- DURDL2025BPK (1033711) DL2025
- DURDL2032BPK (1033695) DL2032
- DURDL2430BPK (1033753) DL2430
- DURDL2450BPK (1013671) DL2450
- DURDLCR2BPK (1033703) DL2CR2
- DURPL123BPK (362798) 12 x 123
- 12 V
- DURMN21B2PK (1013656) 2 x MN21B2



**E**



**F**

## F Hearing Aid Batteries

- DURDA10N8PK (1033836) 8 x DA10N
- DURDA13N8PK (1033844) 8 x DA13N
- DURDA312N8PK (1033852) 8 x DA312N
- DURDA675B6 (1033869) 6 x DA675

## G Value Charger

Charges up to 4 AA or AAA batteries. Includes charger and 4 AA batteries.

- DURCEF14DX4N (552836)



**G**



## H Rechargeable NiMH Batteries

Pre-charged and ready to use. Package of 4.

- DURDX2400B4N (1033760) AAA
- DURDX1500B4N (808329) AA



**H**





**A** APC  
AMERICAN POWER CONVERSION



**B** allocacoc

**A Essential SurgeArrest Surge Protector**

Safeguards against lightning, surges, and spikes. 6 outlets and 2 USB-A ports. 120 V. White.  
**APW P6WU2** (828067)

**B PowerCube Original Power Bar**

Features 4 power outlets and 2 USB ports. USB charger will not interfere with use of outlet. Modular design for added functionality. White and blue.  
**GBM 369082** (369082)

**C Mighty 8 Surge Protector**

8-outlet/phone/fax protection. Accommodates up to 5 AC adapters. EMI/RFI noise filtering. 6 ft power cord with right-angle plug. 1,460 joules. \$50,000 connected equipment warranty.  
**FEL 99091** (306654)



**C** Fellows



**D** Fellows

**D 10-Outlet Surge Protector**

Phone, digital coaxial and network line protection. 3300 joules. 10' power cord with right-angle plug. Colour-coded faces. EMI/RFI noise filtering. LED power indicator light. \$150,000 warranty on connected equipment.  
**FEL 99115** (711101)

**E Power Guard Surge Protector**

8 outlets with colour-coded faces. Swiveling safety cover to protect unused outlets. Auxiliary phone, digital coaxial and cable line protection. 2400 joules. 8' cord. \$100,000 warranty on connected equipment.  
**FEL 99112** (727438)



**E** Fellows



**F** Fellows

**F 6-Outlet Surge Protector**

EMI/RFI noise filtering. 450 joules. 6' cord. \$5000 connected equipment insurance.  
**FEL 99012** (679340)

**G Surge Protector**

Colour-coded swivelling safety covers. Phone line protection. 7 outlets with 6 ft. cord. 1600 joules.  
**FEL 99110** (101469)

**H 6-Outlet surge protector**

6-outlet bar with ground. Illuminated switch and circuit breaker. 15 amp. 4' cord. Platinum  
**FEL 99000** (1013879)



**G** Fellows



**H** Fellows

**I 6-Outlet Surge Protector**

Illuminated switch and circuit breaker. Surge protector and EMI/RFI filters. Plastic case. 6 ft. cord. 750 joules. White.  
**EXM 56904** (335422) 4 ft cord  
**EXM 56902** (240135) 6 ft. cord

**J PROPlugz Surge Protector**

EMI/RFI filters. 1050 joules. 6 ft cord. 6 outlets. Black.  
**EXM 56930** (575712)



**I** EX2ONENT



**J** EX2ONENT

## A Smartsockets® Surge Protector

8 outlets. 8 ft. cord. Modular telephone jacks. Colour-coded wire identification. 15 A circuit breaker. Lifetime warranty. 2490 joules. \$35,000 insurance included.  
**KMW 8589662690** (353441)



**A** Kensington

## B Smartsockets Premium Surge Protector

6 outlets. Recessed push button switch. Modular telephone jacks. Colour-coded wire identification. 15 A circuit breaker. 120 V. Lifetime warranty. \$25,000 insurance included.  
**520 joules - 8 ft. cord**  
**KMW 62144** (301168)  
**670 joules - 6 ft cord**  
**KMW 8589662146** (456046)



**B** Kensington

## C Guardian® Surge Protector

540 joules. Grey. Lifetime warranty.  
**KMW 8589638215** (147629) 6 outlets / 15 ft.  
**KMW 8589638217** (353458) 7 outlets / 6 ft.



**C** Kensington

## D Offix® 201-NP Surge Protector

6 outlets and 2 USB ports. EMI/RFI filters. 1800 joules. 6 ft cord. White.  
**NVX 344614** (344614)



**D** offix

## E 6-outlet Surge Protector

6-outlet bar with ground. Illuminated switch and overload protection shut-down. Surge protector. ABS fire resistant plastic case. CSA Approved. 125 volts. 15 amp. 15 ft. cord. White.  
**CCS 55157** (1013846)



**E** COMPUTESSORY

## F Exentsion Cord

3 outlet indoor extension. 125V/13A. White.  
**EXM 57554** (832962) 6 ft. cord  
**EXM 57555** (832963) 15 ft. cord



**F** EXPONENT



## G Exentsion Cord

Single outlet outdoor-indoor extension cord. 125V/13A. 30 ft cord. Orange.  
**EXM 57556** (832964)

## H Extension Cord

3-pronged heavy-duty cord. Grey.  
**FEL 99596** (101485) 15 ft. cord  
**FEL 99595** (267690) 9 ft. cord



**H** Fellowes

## I Indoor/Outdoor Extension Cord

Heavy-duty for multiple applications. 25'.  
**FEL 99497** (228742)



**G** EXPONENT



## J Extension Cord 16/3

For general purposes. 3-prong, 3 outlets. Black.  
**EXM 57551** (727297) 10 ft. cord  
**EXM 57552** (727305) 15 ft. cord



**I** Fellowes



**J** EXPONENT

# HP closed-loop recycling



When you choose Original HP Cartridges and recycle through HP Planet Partners, you become part of a more circular, sustainable system—where materials are added and reused to make new products, and no cartridges end up in a landfill.

## CIRCULAR ECONOMY

VS

## LINEAR ECONOMY

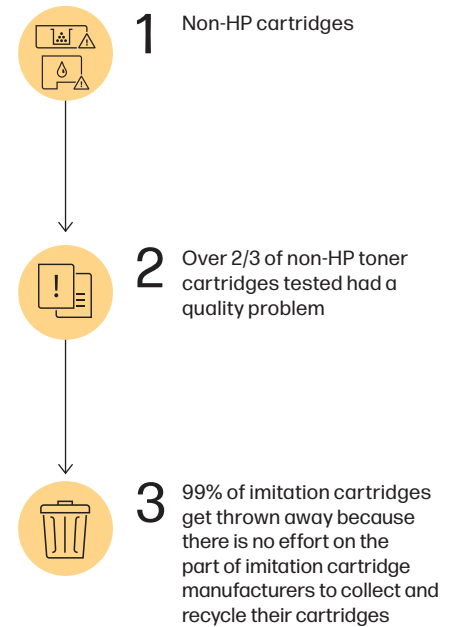
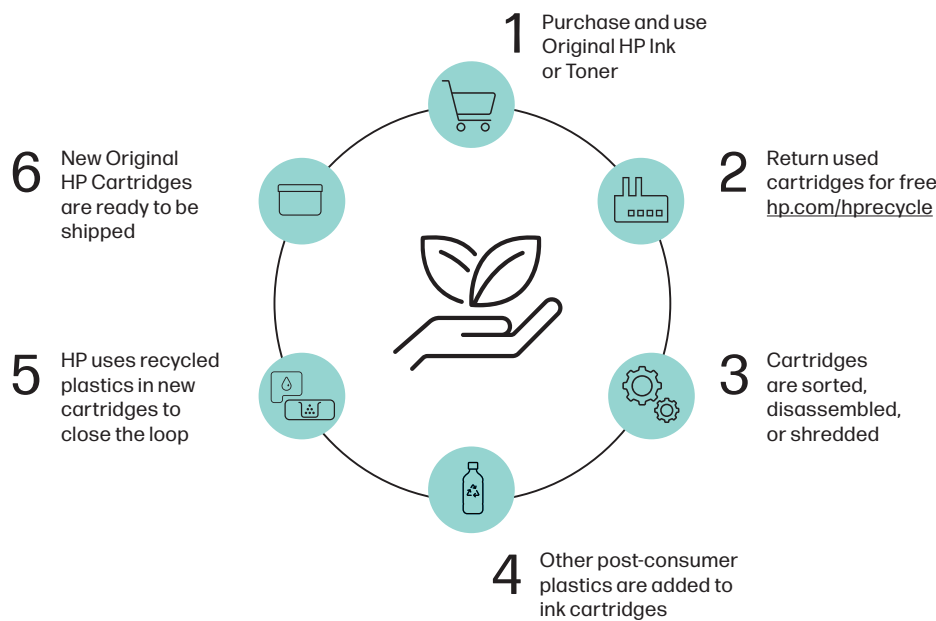

## BRINGING USED PRODUCTS BACK TO LIFE

In HP's closed-loop process, almost every part of the toner cartridge is either recycled or reused; nothing goes to a landfill. HP combines cartridges returned through HP Planet Partners with other plastics, such as reclaimed ocean-bound plastic bottles, to make new Original HP Print Cartridges and other everyday products. Program availability varies. See [hp.com/hprecycle](http://hp.com/hprecycle).

## END UP IN A LANDFILL

Nearly 90% of remanufactured cartridges sold will ultimately end up in a landfill because remanufacturers prefer to work with cartridges that have never been remanufactured before.<sup>4</sup>





## THE COMPLETE SELECTION IS AVAILABLE ONLINE.

Visit our website for details and to find all the latest HP Printers.

### A LaserJet Pro 3001dw Wireless Printer

Print, wireless and auto 2-sided printing. Professional quality black and white prints. 35 ppm.

HEW 3G650FBGJ (831231)

### B LaserJet Pro 4001n/dn Printer

Print only. Professional quality black & white prints. 42 ppm.

HEW 2Z599FBGJ (831232)

### C OfficeJet Pro 9015e Multifunction Wireless Printer

Colour print, copy, scan, fax, 2-sided printing and scanning. Professional quality colour for presentations, brochures and flyers. Up to 32 ppm.

HEW 1G5L3AB1H (831240)

### D ScanJet Pro 2600/3600 F1 Flatbed Scanner

Compact design that fits on the desktop. Two-sided, single-pass auto document feeder. Scan up to 30 ppm.

HEW 20G06ABG (831237)

### E ScanJet Enterprise Flow N4600/N6600 FNW1Scanner

2.8 inch colour touchscreen. Two-sided, single-pass auto document feeder. Scan up to 50 ppm.

HEW 20G07ABGJ (831238)



A



B



C



D



E

## Packed with ink and ready for business

INKvestment Tank all-in-one inkjet printers deliver large in-box page yields and all the features you need to keep up with your printing demands.



MFCJ6955DW



MFC-J4535DW



MFC-J5855DW

### Perfect for your home office and business needs

Kick up your productivity with full print, copy, scan and fax functionality, wireless connectivity, adjustable paper trays and enough ink in the box to print thousands of pages



Keep your business documents secure with Triple Layer Security



The Brother Mobile Connect App puts the power of printing at your fingertips

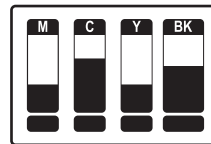

Brother Page Gauge takes the guesswork out of ink replacement

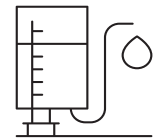

More pages of uninterrupted printing with the internal storage tank



### Worth it every time

Brother Genuine INKvestment Tank cartridges are reengineered to hold more ink than traditional cartridges to deliver quality and performance you consistently rely on.



## THE COMPLETE SELECTION IS AVAILABLE ONLINE.

Visit our website for details and to find all the latest Brother Printers.

### A HL-L6400DW Business Monochrome Laser Printer

Ideal for mid-sized workgroups with demanding print volumes, this monochrome laser printer is a perfect pick for businesses looking for low-cost, reliable printing.

**BRT HLL6400DW** (829909)

### B MFC-L8900CDW Business Colour Laser Multifunction Printer

Advanced duplex printing and wireless networking. Ideal for office and small workgroups with higher print volumes.

**BRT MFL8900CDW** (829911)

### C MFC-J4535DW INKvestment Tank All-In-One Colour Inkjet Printer

For home and small office use. Its reengineered high-capacity in-box ink cartridges provide up to 1-year of uninterrupted printing. Print and copy from your mobile device plus scan and fax.

**BRT MFCJ4535DW** (829904)

### D MFC-J5855DW INKvestment Tank Colour Inkjet All-In-One Printer

Printer with printing capabilities up to 11 x 17 in. With advanced triple layer security is perfect for home office or small business use. Print, copy, scan, and fax from a computer, mobile device, or from its 3.5 LCD colour touchscreen.

**BRT MFCJ5855DW** (829905)



A



B



C



D



**A complete Lexmark line-up that meets your needs from small to large workgroups**



## **New Managed Print offer!**

Ask your Hamster representative about a secure cloud-based solution that frees you from day-to-day printer management which includes:

- ▶ **Service**
- ▶ **Proactive supplies replenishment**
- ▶ **Support**
- ▶ **Remote management capabilities**



## THE COMPLETE SELECTION IS AVAILABLE ONLINE.

Visit our website for details and to find all the latest Lexmark Printers.

### A Lexmark CS431dw Printer

Built for reliability, performance and security, it prints up to 26 ppm and offers expandable input for longer print runs. Take control with a 2.8-inch (7.2 cm) touch screen and connect via Wi-Fi, USB, Ethernet, or the cloud.

**LEX 40N9320** (828002)

### B CX431adw Colour Multifunction Laser Printer

Compact and lightweight. Combines printing at up to 26 ppm with automatic scanning at up to 96 images per minute plus copying and faxing. Take control with a 2.8-inch (7.2 cm) touch screen and connect via Wi-Fi and more.

**LEX 29S0500** (808709)

### C MS823DN Laser Printer

Satisfy large-workgroup requirements for performance, print up to 70 pages per minute. Input capacity of up to 4400 sheets, replacement toner cartridges that go as high as 55,000 pages, long-life imaging unit and a fuser that may never need replacement.

**LEX 50G0200** (832427)

### D MX822ADE Multifunction Laser Printer

Output up to 70 ppm, long-life imaging components, ultra high yield toner capacity, a range of finishing and output options, and up to 1200 sheets of standard input. A 10-inch touch screen with e-Task interface keeps you informed and in control, whether you connect via Ethernet, USB or mobile.

**LEX 25B2000** (832429)



A



B



C



D



# We Make Work, *Work Better*

*Look forward with Xerox*

*Xerox.ca/office*

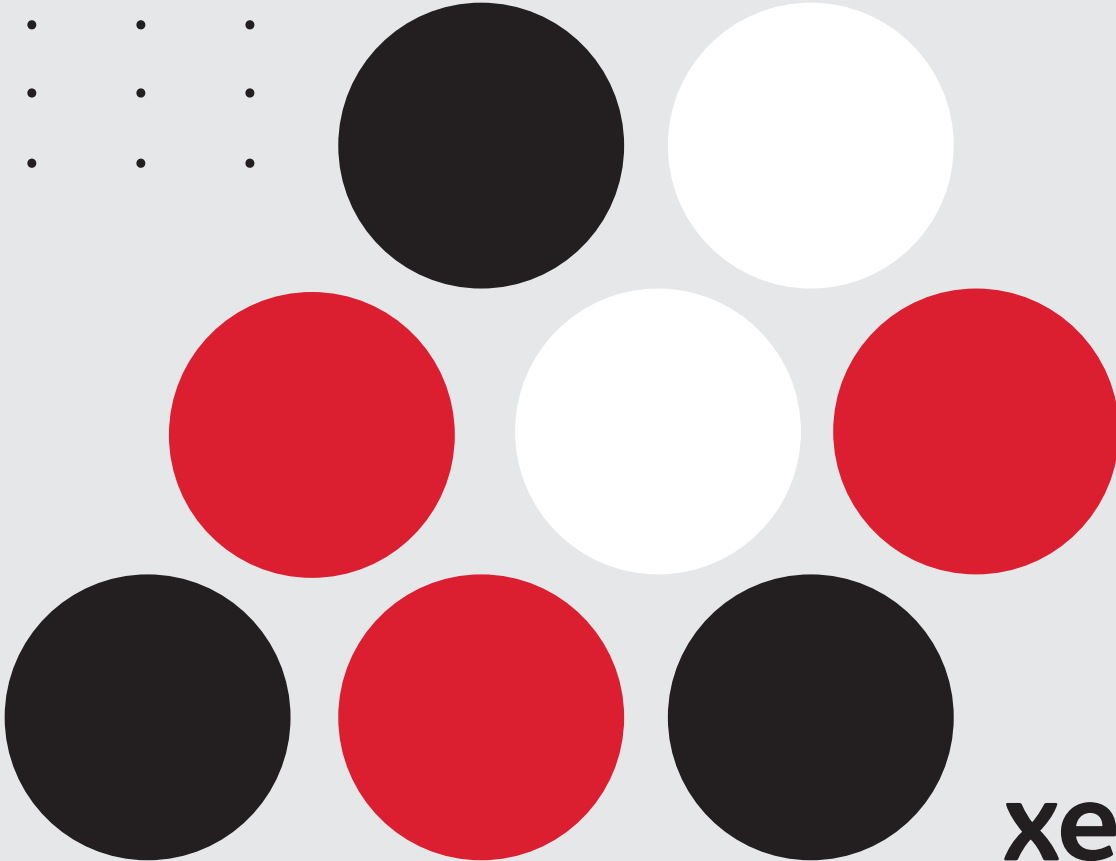

**xerox™**



## THE COMPLETE SELECTION IS AVAILABLE ONLINE.

Visit our website for details and to find all the latest Xerox Printers.

### A C230 Colour Laser Printer

A reliable, secure, and easy-to-use printer perfect for small work teams, home offices, and tight spaces. Maximum resolution of 600 x 600 dpi for sharp documents as well as impressive speeds of up to 24 ppm.

**XER C230/DNI** (832433)



### B C235 Colour Multifunction Laser Printer

Quiet and compact. Ideal for small and medium businesses and home offices. Print, copy, scan, fax, up to 24 ppm. Automatic 2-sided print. USB, Ethernet, Wi-Fi.

**XER C235/DNI** (832434)



### C AltaLink® C8100 Series Colour Multifunction Printer

Big jobs, small jobs, and everything in between – AltaLink® can be customized to do it all. Your choice of finishing options and accessories means you can configure your device for any type of document. AltaLink® B8100 devices will help you do a lot more than just print. You can automate document workflows and connect to the systems that run your business - seamlessly. Protected by comprehensive security features, they are true Digital Workplace Assistants that will free up time for you to do more of what really matters.

**C8130 - 30 ppm, 90,000 images/month**

**XER C8130/H** (832435)

**C8155 - 55 ppm, 300,000 images/month**

**XER C8155/H** (832436)





# SAVE UP TO 60% Versus OEM Toner Cartridges



## Why Choose Elevate Imaging Supplies?

- Endorsed by Lexmark
- A portion of the proceeds from each Elevate Imaging cartridge sold will be donated to Mira Foundation Inc. (Mira.ca)
- Premium line of aftermarket cartridges built to OEM-like standards
- Backed by a limited lifetime warranty
- Industry-leading compliance in environment, health and safety
- Industry-leading overall defect rate of less than 1%
- Made from safe, non-toxic materials, including decaBDE-free plastics



QUALITY & RELIABILITY



SAFETY ASSURANCE



RESPECT FOR INTELLECTUAL PROPERTY



CONSISTENT PRODUCT AVAILABILITY



BETTER VALUE

**CONTACT YOUR REPRESENTATIVE TODAY  
FOR MORE DETAILS.**



Endorsed by  
**Lexmark™**



**Find your toner on our website.**

We offer a vast selection of Original and Compatible Laser Toner Cartridges and Ink Cartridges for most printers available today as well as for your favourite "vintage" printer. We regularly add new products as printer manufacturers launch new models. Can't find the one you need? Just ask your representative or dealer.



Elevate Imaging Toner Cartridges offer a dependable printing solution with maximum productivity. Add sharpness, detail and quality to your documents with laser technology.



**A Elevate Imaging Laser Toner Cartridge - Alternative for HP 414X (W2021X)**  
6000-page yield.  
SQC 831350 (831350)  
cyan  
SQC 831349 (831349)  
yellow  
SQC 831348 (831348)  
magenta

**B Elevate Imaging Remanufactured Laser Toner Cartridge - Alternative for HP 26X (CF226X)**  
SQC 831356 (831356)  
black

**C Elevate Imaging Laser Toner Cartridge - Alternative for HP 58X (CF258X)**  
SQC 831357 (831357)  
black

**D Elevate Imaging Remanufactured Laser Toner Cartridge - Alternative for HP 508X, CRG-040H (CF360X, 0461C001)**  
SQC 831355 (831355)  
black  
SQC 831354 (831354)  
yellow  
SQC 831352 (831352)  
magenta



## A Brother TN660 High Yield Compatible Toner Cartridge

For Brother DCPL2520DW, DCPL2540DW, HLL2300D, HLL2305W, HLL2320D, HLL2340DW, HLL2360DW, HLL2380DW, MFCL2680W, MFCL2700DW, MFCL2705DW, MFCL2707DW, MFCL2720DW, MFCL2740DW.  
Cartridge yield (up to): 2,600 pages. Black.  
**DNS NCBRTN660** (380220)



## B Brother TN760 High Yield Compatible Toner Cartridge

For Brother DCPL2550DW, HLL2350DW, HLL2370DW, HLL2370DW XL, HLL2390DW, HLL2395DW, MFCL2710DW, MFCL2750DW, MFCL2750DWXL.  
Cartridge yield (up to): 3,000 pages. Black.  
**DNS NCBRTN760** (578690)

## C High Yield Compatible Toner Cartridge (Alternative to HP 30X)

For HP HP LaserJet Pro M203d, M203dn, LaserJet pro M203dw, M203dn, MFP M227d, MFP M227fdn, MFP M227sdn. Cartridge yield (up to): 3,500 pages. Black.  
**DNS NCHP230X** (584276)



## D High Yield Compatible Toner Cartridge (Alternative to HP 26X)

For HP LaserJet Pro M402, M426. Cartridge yield (up to): 9,000 pages. Black.  
**DNS NCHPCF226X** (382895)

## E Compatible Toner Cartridge (Alternative to HP CF258A)

For LaserJet Pro M304, LaserJet Pro M304a, LaserJet Pro M305d, LaserJet Pro M305dn, LaserJet Pro M404d, LaserJet Pro M404dn, LaserJet Pro M404dw, LaserJet Pro M404n, LaserJet Pro M405d, LaserJet Pro M405dn, LaserJet Pro M405n, LaserJet Pro MFP M428dw, LaserJet Pro MFP M428fdn, LaserJet Pro MFP M428fdw, LaserJet Pro MFP M428m. Cartridge yield (up to): 3,000 pages. Black.  
**DNS NCHPCF258A** (832622)



## F Compatible Toner Cartridge (Alternative to HP W2020A-414A)

For Color LaserJet Enterprise M455dn, Color LaserJet Enterprise MFP M480f, Color LaserJet Pro MFP M478, Color LaserJet Pro M454dn, Color LaserJet Pro M454dw, Color LaserJet Pro MFP M479fdn, Color LaserJet Pro MFP M479fdw, Color LaserJet Pro MFP M479fd. Cartridge yield (up to): 2,400 pages. Black.  
**DNS NCHPW2020A** (832623)

## G Remanufactured Lexmark 51B1000 Toner Cartridge

For Lexmark MX317de, MS317dn, MS417dn, MS517dn, MS617dn, MX417de, MX517de, MX617de. Cartridge yield (up to): 2,500 pages. Black.  
**DNS 591925** (591925)



## H Remanufactured Ink Cartridge (Alternative to HP 63XL)

Inkjet cartridge. For DeskJet 1110, DeskJet 1111, DeskJet 1112, DeskJet 1113, DeskJet 1114, DeskJet 2130 All-in-One, DeskJet 2131 All-in-One, DeskJet 2132 All-in-One, DeskJet 2133 All-in-One, DeskJet 2134 All-in-One, DeskJet 2136 All-in-One, DeskJet 2137 All-in-One, DeskJet 3630 All-in-One, DeskJet 3632 All-in-One, ENVY 4511, ENVY 4512, ENVY 4516, ENVY 4520, ENVY 4521, ENVY 4522, ENVY 4524, OfficeJet 3830 All-in-One, OfficeJet 4650 All-in-One. Yield up to 480 pages (black) and 330 (tri-color).  
**DNS RHP63XLCEI** (823908)



**i** Find your toner on our website. We regularly add new products as printer manufacturers launch new models.



**STACK**



**WALK  
AWAY**



**SHUT**

# **GBC** AutoFeed+ SHREDDERS

**Don't spend time standing by the shredder.**

AutoFeed+ lets you place stacks of paper into the feeder tray, close the lid, and walk away. Your papers will shred automatically while you focus on other tasks. Models range from 60 to 750 sheets and offer either super cross-cut (P4) or micro-cut (P-5) Level Security. **Save time. Secure. Uninterrupted shredding.**



**Time Savings is Automatic.**



Security Level P-5



**A** GBC  
EM09-06  
GBC 57397 (277764)

**B** GBC  
ShredMaster® SM10-06  
GBC 1758499F (827872)



Auto-feed 300 sheets



**C** GBC  
Autofeed+ 300M  
GBC WSM1757609 (827904)



**D** GBC  
Momentum M12-12  
GBC WSM177003 (829498)



**E** GBC  
Momentum M20-32  
GBC WSM177006 (829499)



MODEL	A. EM09-06	B. SM10-06	C. 300M	D. M12-12	E. M20-32
SECURITY LEVEL	P-5	P-5	P-5	P-5	P-5
NUMBER OF USERS	1-2	1-2	5-10	5-10	10+
CUT STYLE	micro 5/64 x 19/32"	micro 1/16 x 9/16"	micro 3/32 x 5/8"	micro 5/16 x 19/32"	micro 5/16 x 19/32"
SHEET CAPACITY	9	10	8	12	20
ON/OFF CYCLE (MIN.)	10/45	120/60	60/45	continuous	continuous
DIMENSIONS H" X W" X D"	24.5 x 14 x 18.7	18.3 x 14.6 x 11	29 x 17 x 19	26.6 x 18.9 x 17.5	40.5 x 21.8 x 20.1
BIN CAPACITY (GALLONS)	6	6	16	12	32
WARRANTY (CUTTERS)	7 years	2 years	20 years	2 years	2 years
WARRANTY (MACHINE)	2 years	2 years	2 years	2 years	2 years

# Next Generation Shredders

More Shredding. Zero Jamming.

In Your Office



In Your Home Office



## LX SERIES

The next level of performance from a fourth-generation family business dedicated to quality.

Work Better, Feel Better™



Security Level P-4



**A** **Fellowes**  
**Powershred® 6C**  
 FEL 4771502 (1043653)



**B** **Fellowes**  
**Powershred® LX200**  
 FEL 5015001 (597757) black  
 FEL 5015101 (597740) white



**C** **Fellowes**  
**Powershred® LX210**  
 FEL 5015201 (597732) black  
 FEL 5015301 (597724) white



**D** **Fellowes**  
**Powershred® LX220**  
 FEL 5015401 (597716) black  
 FEL 5015501 (597708) white



**E** **Fellowes**  
**Powershred® 125Ci**  
 FEL 3312501 (116947)



**F** **Fellowes**  
**Powershred® 225Ci**  
 FEL 3825001 (116962)

MODEL	A. 6C	B. LX200	C. LX210	D. LX220	E. 125Ci	F. 225Ci
SECURITY LEVEL	P-4	P-4	P-4	P-4	P-4	P-4
NUMBER OF USERS	1	1-2	1-2	1-2	1-5	3-5
CUT STYLE	cross-cut 5/32 x 1-3/8"	micro 5/32 x 1/2"	micro 5/32 x 1/2"	micro 5/32 x 1/2"	cross-cut 5/32 x 1-1/2"	cross-cut 5/32 x 1-1/2"
SHEET CAPACITY	6	12	16	20	20	22
ON/OFF CYCLE (MIN.)	3/30	10/15	20/15	30/15	continuous	continuous
DIMENSIONS H" X W" X D"	14.4 x 11.8 x 6.7	20.7 x 10.3 x 14.5	21 x 11.7 x 14	23.2 x 11.7 x 16.5	28.9 x 11.2 x 21	30.7 x 17 x 17.7
BIN CAPACITY (GALLONS)	3	6	6	8	14	16
WARRANTY (CUTTERS)	3 years	7 years	7 years	7 years	lifetime	lifetime
WARRANTY (MACHINE)	1 year	2 years	2 years	2 years	2 years	2 years

**Security Level P-4**



**A** **Fellowes**  
**Powershred® LX45**  
 FEL 4400201 (804807)

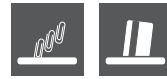

**B** **Fellowes**  
**Powershred® LX65**  
 FEL 4400301 (804815)



**C** **GBC**  
**ShredMaster® PSX10-06**  
 GBC 3381650316 (829481)



**D** **Fellowes**  
**Powershred® LX85**  
 FEL 4400401 (804823)



**E** **Fellowes**  
**Powershred® LX170**  
 FEL 5501401 (804773)



**F** **Fellowes**  
**Powershred® LX180**  
 FEL 5501601 (804781)



Auto-feed 230 sheets



**G** **GBC**  
**Autofeed+ 230X**  
 GBC WSM1757606 (827905)



MODEL	A. LX45	B. LX65	C. PSX10-06	D. LX85	E. LX170	F. LX180	G. 230X
SECURITY LEVEL	P-4	P-4	P-4	P-4	P-4	P-4	P-4
NUMBER OF USERS	1-2	1-2	1-2	1-2	1-5	3-5	1-5
CUT STYLE	cross-cut 5/32 x 1-15/32"	cross-cut 5/32 x 1-9/16"	cross-cut 5/32 x 1/2"	cross-cut 5/32 x 1-9/16"	cross-cut 5/32 x 1-3/8"	cross-cut 5/32 x 1-3/8"	cross-cut 5/32 x 1-3/16"
SHEET CAPACITY	8	10	10	12	12	16	10
ON/OFF CYCLE (MIN.)	6/20	6/20	6/60	20/30	10/15	20/15	30/auto
DIMENSIONS H" X W" X D"	15.8 x 12.2 x 8.7	16 x 9.2 x 14.6	14.8 x 10.1 x 14.6	19.5 x 9.5 x 13.4	28.9 x 11.2 x 21	21 x 11.7 x 14	29 x 17 x 19
BIN CAPACITY (GALLONS)	4.4	6	6	5	6	6	16
WARRANTY (CUTTERS)	3 years	5 years	2 years	5 years	7 years	7 years	10 years
WARRANTY (MACHINE)	1 year	1 year	2 years	2 years	2 years	2 years	2 years



Security Level P-2 and P-3



**A** *Swingline*

**GS5**  
GBC 09369 (792424)



**B** **GBC**  
**ShredMaster® PS06-02**  
GBC 1757402 (827871)



**C** *Swingline*

**GX5**  
GBC 09370 (792432)



**D** **GBC**  
**ShredMaster® PX08-04**  
GBC 3381650313 (597393)



**E** **Fellowes**  
**Powershred® 60Cs**  
FEL 4606004 (192641)



**F** **GBC**  
**ShredMaster® PSX12-06**  
GBC 50317 (573303)

MODEL	A. GS5	B. PS06-02	C. GX5	D. PX08-04	E. 60Cs	F. PSX12-06
SECURITY LEVEL	P-2	P-2	P-3	P-3	P-4	P-3
NUMBER OF USERS	1	1	1	1	1	1-2
CUT STYLE	strip-cut 1/4 x 11"	strip-cut 1/4 x 11"	cross-cut 3/16 x 1-1/2"	cross-cut 1/4 x 2"	cross-cut 5/32 x 1-9/16"	cross-cut 1/4 x 2"
SHEET CAPACITY	5	6	5	8	10	12
ON/OFF CYCLE (MIN.)	3/30	2/60	3/30	3/60	6/20	6/60
DIMENSIONS H" X W" X D"	13.1 x 10.4 x 4.1	12.6 x 11.3 x 6.1	13.9 x 11.6 x 5.5	13.5 x 12.8 x 9	16.2 x 9.2 x 14.6	4.8 x 10.1 x 14.6
BIN CAPACITY (GALLONS)	2.6	2.38	3.7	4	6	6
WARRANTY (CUTTERS)	1 year	2 years	1 year	2 years	5 years	2 years
WARRANTY (MACHINE)	1 year	2 years	1 year	2 years	1 year	2 years

**A** Shredder Bags

CODE	REFERENCE	DIMENSIONS	FOR SHREDDERS	QTY/BOX	PRICE
FEL 36052	156927	26"H x 15"W x 9"D	12Cs, 46MS, 60Cs, CC1021, DS-700C, DS12Cs, 63CB, 70S, 73Ci, 79Ci	100	
FEL 36053	415851	30"H x 15"W x 14"D	99Ci, 150C, 200C, 200M	100	
FEL 36054	408633	36"H x 18"W x 13"D	125i, 125Ci, 225i, 225Ci, 300C	50	
FEL 36055	33381	51"H x 22"W x 17"D	C380, C380C	50	
FEL 36056	310847	39"H x 21"W x 15"D	325i, 325Ci	50	
FEL 3604101	170639	50"H x 42.5"W x 22"D	500CL, 3850 series, HS-660, HS880, HS1010	50	
FEL 3605801	739698	39"H x 23"W x 21"D	425i, 425Ci	50	
FEL 3608401	343244	21.5"H x 39"W x 23.5"D	500C, 300C, 300CL	50	



**C** Shredder Bags



CODE	REFERENCE	DIMENSIONS	FOR SHREDDERS	QTY/BOX	PRICE
GBC 65010	607713	38"H x 13"W x 14"D	DX18-13, DS22-13, 300X	25	
GBC 65015	151365	48"H x 15"W x 18"D	500X, 500M, 600X, 750X, 750M	25	
GBC 65016	700724	25"H x 16"W x 17"D	SC170, ES12-06, EX12-05, EX14-06, SM12-08, 100X, 100M, 130X, 130M, 200X, 230X	25	

CODE	REFERENCE	DIMENSIONS	FOR SHREDDERS	QTY/BOX	PRICE
MBM AC0901	573741	54"W x 48"H	4002, 4202, 4000ss	80	
MBM AC0920	573923	33"W x 47"H	2502, 2503, 2602, 2603, 2604, 3102, 3103, 3104	80	



**F** Destroyit Shredder Oil  
For use in Destroy-it shredders.  
473 ml / 16 oz.  
MBM ACCED21/4 (516294)



**G** RS-SLS Lubricant Sheets  
Ensure shredder blades maintain a clean cut. Help prevent paper jam. Reduce noise and paper dust. Package of 10.  
RSI RS-SLS (277640)



# DYMO®

## LetraTag® 200B Bluetooth®

Bluetooth Connected

Electronic Label Maker

Intuitive mobile labelling for home, on-the-go, school or home office!



**NEW**



Portable Label Maker With Bluetooth® Wireless Technology  
Hamster # 829917



DYMO® LetraTag® Connect - Easily Design Your Labels!

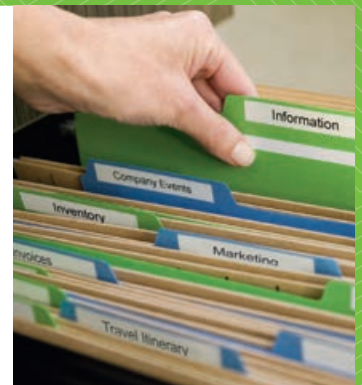

Complete your work professionally with sustainability in mind!



Recycled external cassette\*



Recycled packaging



The mark of responsible forestry

\*Authentic DYMO® LetraTag®, LabelWriter™ Paper labels. \*\*External cassette of LetraTag®, D1®, RHINO IND

 <p><b>A</b> <b>DYMO</b> and done. <b>LabelWriter® 5XL</b> DYM 2112554 (829138)</p>	 <p><b>B</b> <b>DYMO</b> and done. <b>LabelWriter® 450 Duo</b> DYM 1752267 (116160)</p>	 <p><b>C</b> <b>DYMO</b> and done. <b>LabelWriter® 450 Twin Turbo</b> DYM 1752266 (116152)</p>
<p>Print from smartphone or tablet</p>  <p><b>D</b> <b>DYMO</b> and done. <b>LabelWriter® Wireless</b> DYM 2002150 (426973)</p>	 <p><b>E</b> <b>DYMO</b> and done. <b>LabelWriter® 550 / 550 Turbo</b> 550 DYM 2112553 (829137) 550 Turbo DYM 2112552 (829136)</p>	 <p><b>F</b> <b>DYMO</b> and done. <b>LabelManager® PnP</b> DYM 1768960 (170621)</p>

MODEL	A. LW 5XL	LW 450 DUO	LW 450 TWIN TURBO	LW WIRELESS	LW 550/550 TURBO	LM PNP
<b>TYPE OF TAPE (MAX WIDTH)</b>	LW (105.73 mm)	LW & D1 (60 mm)	LW (60 mm)	LW (60 mm)	LW (61mm)	D1 (12 mm)
7.1 X 5.4 X 7.4	.	.	.	.	.	.
<b>WIFI</b>				.		
<b>ETHERNET</b>	.				.	
<b>SOFTWARE TO INSTALL</b>	.	.	.	.	.	
<b>PRINTS TEXT, IMAGES &amp; PICTURES</b>	.	.	.	.	.	.
<b>FONTS TYPE</b>	unlimited	unlimited	unlimited	unlimited	unlimited	unlimited
<b>NUMBER OF FONT STYLES</b>	unlimited	unlimited	unlimited	unlimited	unlimited	unlimited
<b>LABELS PER MINUTE*</b>	53	71	71	71	62 / 90	n/a
<b>BAR CODE PRINTING</b>	.	.	.	.	.	.
<b>VERTICAL PRINTING</b>	.	.	.	.	.	.
<b>MIRROR EFFECT PRINTING</b>	.	.	.	.	.	
<b>NUMBER OF SYMBOLS</b>	Win/Mac fonts	Win/Mac fonts	Win/Mac fonts	Win/Mac fonts	Win/Mac fonts	Win/Mac fonts
<b>PRINTING HEIGHT (MAX)</b>	101 mm	101 mm	101 mm	101 mm	101 mm	8.1 mm
<b>PRINTING WIDTH (MAX)</b>	56 mm	56 mm	56 mm	59 mm	56 mm	12 mm
<b>TAPE CUTTER</b>	manual	manual	manual	manual	manual	manual
<b>DIMENSIONS CM (L X D X H)</b>	71 x 5.4 x 7.4	14 x 18.4 x 20.3	21.7 x 18.7 x 13.5	8 x 5 x 4.9	5 x 5.4 x 7.4	5.3 x 13.6 x 14.1
<b>WEIGHT</b>	885 g	1350 g	1090 g	653 g	640 g	329 g
<b>ADAPTER / CHARGER</b>	.	.	.	.	.	.
<b>WARRANTY</b>	2 years, limited	2 years, limited	2 years, limited	2 years, limited	2 years, limited	1 year, limited

\*4-LINE ADDRESS LABEL

# Label Makers and Tapes | Office Machines



**A** **brother**  
at your side

**QL-1110NWB**  
BRT QL1110NB (579201)



**B** **brother**  
at your side

**QL-820NWB**  
BRT QL820NB (425702)



**C** **brother**  
at your side

**QL-810WC**  
BRT QL810W (424994)



**D** **brother**  
at your side

**QL-800**  
BRT QL800 (450080)



**E** **brother**  
at your side

**QL-600**  
BRT QL600 (827902)

MODEL	A. QL-1110NWB	B. QL-820NWB	C. QL-810WC	D. QL-800	E. QL-600
TYPE OF TAPE (MAX WIDTH)	DK (101 mm)	DK (62 mm)	DK (62 mm)	DK (61 mm)	DK (62 mm)
USB				•	•
WIFI	•	•	•		•
ETHERNET	•	•	•	•	
SOFTWARE TO INSTALL	•		•	•	•
PRINTS TEXT, IMAGES & PICTURES	•	•	•	•	•
FONTS TYPE	True Type	6	True Type	unlimited	unlimited
NUMBER OF FONT STYLES	unlimited	3	8	unlimited	unlimited
LABELS PER MINUTE*	69	110	110	93	44
BAR CODE PRINTING	•	•	•	•	•
VERTICAL PRINTING	•	•	•	•	•
MIRROR EFFECT PRINTING	•	•	•		•
NUMBER OF SYMBOLS	1379	1379	1379	1379	1379
PRINTING HEIGHT (MAX)	249 mm	58.42 mm	58 mm	61 mm	61 mm
PRINTING WIDTH (MAX)	99 mm	58 mm	61 mm	58 mm	62 mm
TAPE CUTTER	auto	auto	auto	auto	auto
DIMENSIONS CM (L X D X H)	17 x 21.9 x 14.8	12.5 x 23.4 x 14.5	12.5 x 23.4 x 14.5	21.3 x 12.5 x 14.2	12.8 x 22.1 x 15.3
WEIGHT	3.0 kg	1600 g	178 kg	1100 g	1.1 kg
BATTERIES					•
ADAPTER / CHARGER	•	•	•	•	•
WARRANTY	2 years exchange, limited	2 years exchange, limited	2 years exchange, limited	2 years exchange, limited	2 years exchange, limited

\*4-LINE ADDRESS LABEL



**A** **brother**  
at your side

**PT-P710BT**  
BRT PT-P710BT (585182)



**B** **brother**  
at your side

**PT-P700**  
BRT PT-P700 (248765)



**C** **brother**  
at your side

**PT-P300BT**  
BRT PTP300BTAD (598144)



**D** **brother**  
at your side

**PT-P750W**  
BRT PTP750W (281550)

MODEL	A. PT-P710BT	B. PT-P700	C. PTP300BTAD	D. PT-P750W
TYPE OF TAPE (MAX WIDTH)	Tze (24mm)	Tze (24mm)	Tze (12mm)	Tze (24mm)
COMPUTER CONNECTION	PC/MAC (USB)	PC/Mac (USB)	n/a	PC/MAC (USB)
WIFI	•	•		•
ETHERNET				
SOFTWARE TO INSTALL	•		•	•
PRINTS TEXT, IMAGES & PICTURES	•		•	•
FONTS TYPE	unlimited	unlimited	unlimited	True Type
NUMBER OF FONTS STYLES	all True Type	unlimited	all True Type	all True Type
LINES PER LABEL	Variable	unlimited	2	Variable
LABELS PER MINUTE*	20 mm /sec	20 mm /sec	20 mm /sec	30 mm /sec
BAR CODES PRINTING	•	•	Yes (QR code)	•
VERTICAL PRINTING	•	•	•	•
MIRROR EFFECT PRINTING		•		•
NUMBER OF SYMBOLS	1900+	694	450+	1900+
PRINTING HEIGHT (MAX)	18 mm	18 mm	9mm	18 mm
PRINTING WIDTH (MAX)	n/a	n/a	n/a	n/a
TAPE CUTTER	auto	auto	manual	auto
DIMENSION CM (L X D X H)	12.8 x 6.7 x 12.8	5.3 x 15.8 x 11.2	11.5 x 6.1 x 11.5	7.8 x 15.2 x 14.3
WEIGHT	0.67 kg	730 g	0.38 kg	0.8 kg
BATTERIES	n/a	6 x AA (not included)	6 x AAA (not included)	n/a
ADAPTER / CHARGER	USB Cable	•	•	•
LI-ION BATTERY	integrated	n/a	n/a	optional
WARRANTY	1 year exchange limited	1 year exchange limited	1 year exchange limited	1 year exchange limited

\* 4-LINE ADDRESS LABEL



**A** **brother**  
at your side

**PT-D610BT**  
**BRT PTD610BT** (829916)



**B** **brother**  
at your side

**PT-D460BT**  
**BRT PTD460BT** (829915)



**C** **brother**  
at your side

**PT-D410**  
**BRT PTD410** (829914)



**D** **brother**  
at your side

**PT-D210BK**  
**BRT PTD210BK** (364018)



**E** **brother**  
at your side

**PT-H110**  
**BRT PTH110** (424598)



**F** **brother**  
at your side

**PT-M95**  
**BRT PTM95** (371310)

MODEL	A. PT-D610BT	B. PT-D460BT	C. PT-D410	D. PT-D210BK	E. PT-H110	F. PT-M95
TYPE OF TAPE (MAX WIDTH)	Tze (24mm)	Tze (18mm)	Tze (18mm)	Tze (12mm)	Tze (12mm)	M (12mm)
USB	•	•	•			
SOFTWARE TO INSTALL	•	•	•			
PRINTS TEXT, IMAGES & PICTURES	text, images	text, images	text, images			text, images
FONTS TYPE	17	16	15	14	3	2
NUMBER OF FONT STYLES	17	15	13	10	10	9
LINES PER LABEL	7	5	5	2	2	2
BAR CODE PRINTING	•	•	•	•		
VERTICAL PRINTING	•	•	•	•	•	
MIRROR EFFECT PRINTING	•	•	•	•		
NUMBER OF SYMBOLS	900	800	700	617	253	210
PRINTING HEIGHT (MAX)	18 mm	15.8 mm	15.8 mm	15.8 mm	9 mm	8 mm
TAPE CUTTER	auto	manual	manual	manual	manual	manual
KEYBOARD TYPE	QWERTY	QWERTY	QWERTY	QWERTY	QWERTY	QWERTY
DIMENSIONS CM (L X D X H)	20.2 x 19.9 x 8.7	18.7 x 17.8 x 7.2	18.7 x 17.8 x 7.2	18.7 X 17.7 X 7.2	11 x 20.5 x 5.8	11.2 x 15.5 x 6.1
WEIGHT	990 g	760 g	770 g	700 g	400 g	259 g
BATTERIES	6 x AA (not included)	6 x AA (not included)	6 x AA (not included)	6 x AA (not included)	6 x AAA (not included)	4 x AAA (not included)
ADAPTER / CHARGER	•	•	•	•	optional	•
WARRANTY	1 year, limited	1 year, limited	1 year, limited	1 year, limited	1 year, limited	2 years, limited



**A** **DYMO**  
and done.  
**LabelManager® 280**  
DYM 1815990 (192773)



**B** **DYMO**  
and done.  
**LabelManager® 160**  
DYM 1790415 (170605)  
• Value bundle includes 2 D1 cartridges.  
DYM 1958745 (366716)



**C** **DYMO**  
and done.  
**LabelManager® 210D**  
DYM 1738345 (776161)  
• Starter kit includes carry case, AC adaptor  
and 2 D1 cartridges.  
DYM 1738976 (324574)



**D** **DYMO**  
and done.  
**LetraTag 100T**  
DYM 1733013 (829114)



**E** **DYMO**  
and done.  
**LetraTag Plus LT100H**  
DYM 21455 (757187)

MODEL	A. LM 280	B. LM 160	C. LM 210D	D. LT 100T	E. LT 100H
TYPE OF TAPE (MAX WIDTH)	D1 (12 mm)	D1 (12mm)	D1 (12 mm)	Letra Tag (12 mm)	Letra Tag (12 mm)
FONTS TYPE	3	6	6	5	5
NUMBER OF FONT STYLES	7	8	7	7	7
LINES PER LABEL	2	2	2	2	2
BAR CODE PRINTING	•	•			
VERTICAL PRINTING	•	•	•	•	•
MIRROR EFFECT PRINTING	•		•		
NUMBER OF SYMBOLS	222	228	132	195	195
PRINTING HEIGHT (MAX)	8.1 mm	9 mm	8 mm	4.7 mm	4.7 mm
TAPE CUTTER	manual	manual	manual	manual	manual
KEYBOARD TYPE	QWERTY	QWERTY	QWERTY	QWERTY	ABCD
DIMENSIONS CM (L X D X H)	10.8 x 4.7 x 20.6	11.8 x 4.9 x 20.3	15.5 x 16.5 x 6.4	22 x 8.3 x 22.9	9.5 x 21.5 x 6.5
WEIGHT	395 g	350 g	812 g	480 g	280 g
BATTERIES		6 x AA (not included)	6 x AA (not included)	4 x AA (not included)	4 x AA (not included)
ADAPTER / CHARGER	•	optional	optional		
WARRANTY	1 year, limited	1 year, limited	1 year, limited	1 year, limited	1 year, limited





**A** **DYMO**  
and done.  
**Letra Tag 200B**  
DYM 2179979 (829917)



**B** **DYMO**  
and done.  
**Rhino™ 6000+**  
DYM 2122499 (832961)



**C** **DYMO**  
and done.

**Rhino™ 5200**  
DYM 1755749 (239434)  
• Hard case kit includes 2 tape cartridges, user guide,  
Li-ion battery and AC adapter.  
DYM 1756589 (219378)



**D** **DYMO**  
and done.  
**Rhino™ 4200**  
DYM 1801611 (219394)

MODEL	A. Letra Tag 200B	B. Rhino™ 6000+	C. Rhino™ 5200	D. Rhino™ 4200
TYPE OF TAPE (MAX WIDTH)	LT (12 mm)	Rhino (24 mm)	Rhino (12 mm)	Rhino (12 mm)
USB		•		
SOFTWARE TO INSTALL	•	•		
PRINTS TEXT, IMAGES & PICTURES	Text, emojis	Text		
FONTS TYPE	7	7	n/a	n/a
NUMBER OF FONT STYLES	7	5	n/a	n/a
LINES PER LABEL	2	5	5	5
BAR CODE PRINTING		•	•	•
VERTICAL PRINTING	•	•	•	•
MIRROR EFFECT PRINTING				•
NUMBER OF SYMBOLS	165	100	100	50
PRINTING HEIGHT (MAX)	1/2"	n/a	n/a	n/a
TAPE CUTTER	manual	auto	manual	manual
KEYBOARD TYPE	n/a	ABC	ABCD	QWERTY
DIMENSIONS CM (L X D X H)	12 x 12 x 4.5	13.7 x 24.6 x 6.4	11.2 x 6.1 x 3.5	8.7 x 3 x 1.8
WEIGHT	420 g	1800 g	900 g	900 g
BATTERIES	4 x AA (not included)	rechargeable	6 x AA (not included)	4 x AA (not included)
ADAPTER / CHARGER		•	•	•
WARRANTY	1-year, limited	1-year, limited	1 year, limited	1 year, limited



**A** **DYMO**  
and done.



**B** **DYMO**  
and done.



**A Office Mate II Embossing Machine**  
Plastic casing. Horizontal printing. Uses 3/8" tape.  
Forward/reverse tape feed. Jam-free cutter has automatic tabs for easy tape-backing removal.  
**DYM 154000** (14068)

**B Organizer Xpress Hand-Held Label Maker**  
Turn-and-click system. 49-character wheel. Prints letters, numbers, and symbols. Soft-grip handle. Enhanced tape-cutting feature makes the labels easy to load, cut, and remove.  
**DYM 12965** (828432)

**C Embossing Tapes**  
Glossy vinyl finish. 3/8" x 9' 8". For manual labeller.  
**Single refill**  
**DYM520109** (787341) black  
**DYM520109** (787333) red  
**DYM520109** (787358) blue  
**Package of 3 refills**  
**DYM 1741671** (116103) red, blue, green  
**DYM 1741670** (116095) black

**D Aluminum Embossing Tape**  
Ideal for use on tools, equipment, industrial cabinetry and shelving. Made of aluminum. With adhesive backing. 1/2 in x 12 ft roll. To used with the manual Dymo M1011 labeller.  
**DYM 35800** (1044924)

**E Cleaning Card for Label Writer Label Printer**  
Quickly removes contamination from printheads. Individually wrapped cards protected from dust and debris. Improves print quality and extends life of thermal printers. For use with all Dymo LabelWriter (sold separately). Box of 10.  
**DYM 60622** (1044932)



**C** **DYMO**  
and done.

Find Labeling Guns and Labels on **pages 286-287**













**D** **DYMO**  
and done.

Improves print quality and extends life of thermal printers



**E** **DYMO**  
and done.

	<b>Labels for Rhino labellers, black on white</b>					
	<b>Type</b>	<b>Code</b>	<b>Reference</b>	<b>Size</b>		
A	Vinyl	DYM 18444	219402	1/2" x 18"		
A	Permanent Polyester	DYM 18483	219410	1/2" x 18"		
A	Nylon	DYM 18488	219451	1/2" x 11-1/2"		
A		DYM 18489	219485	3/4" x 11-1/2"		
A	For Heat-Shrink Tube	DYM 18055	239400	1/2" x 5"		
	<b>Avery Thermal White Labels</b>					
	<b>Type</b>	<b>Code</b>	<b>Reference</b>	<b>Size</b>	<b>Qty</b>	
B	Address	AVE 04150	254714	3-1/2 x 1-1/8"	260	
B	Shipping	AVE 04153	402305	2-1/8 x 4"	140	
	<b>Durable Labels for LabelWriter Printers</b>					
	<b>Type</b>	<b>Code</b>	<b>Reference</b>	<b>Size</b>	<b>Colour</b>	<b>Qty</b>
C	Multipurpose	DYM 1976411	1044940	1 x 2-1/8"	white	160
C		DYM 1933088	429746	2-5/16 x 4"	white	300
	<b>Labels for LabelWriter Printers</b>					
	<b>Type</b>	<b>Code</b>	<b>Reference</b>	<b>Size</b>	<b>Colour</b>	<b>Qty</b>
D	Address	DYM 30251	663849	1-1/8 x 3-1/2"	white	260
D		DYM 30320	428144	1-1/8 x 3-1/2"	white	520
D		DYM 30252	739672	1-1/8 x 3-1/2"	white	700
D		DYM 30321	739664	1-2/5 x 3-1/2"	white	520
D		DYM 30254	663856	1-1/8 x 3-1/2"	clear	130
D	Shipping	DYM 1763982	598169	2-5/16 x 4"	white	250
D		DYM 30256	663872	2-5/16 x 4"	white	300
D		DYM 30323	663864	2-1/8 x 4"	white	220
D	For File Folders	DYM 30327	663898	9/16 x 3-7/16"	white	260
D	Multipurpose	DYM 30332	281204	1 x 1"	white	750
D		DYM 30336	116087	1 x 2-1/8"	white	500
D		DYM 30324	803742	2-1/8 x 2-3/4"	white	400
D		DYM 2133382 	827824	2-1/8 X 4"	yellow	220
D		DYM 2133383 	827825	2-1/8 X 4"	red	220
D		DYM 30334	584797	2-1/4 x 1-1/4"	white	1000
D	Multipurpose Removable	DYM 30370	281220	2 x 2-5/16"	white	250
D		DYM 30333	388140	1/2 X 1"	white	1000
D	Adhesive Name Badges	DYM 30857	239491	2-1/4 x 4"	white	250
D	Return	DYM 30330	281196	3/4 x 2"	white	500
D	For LabelWriter 4XL only	DYM 1744907	827670	4 x 6"	white	220
	<b>For QL-500, 550, 570, 650TD, 700, 710W, 720NW, 800, 1050, 1050N, 1060N</b>					
	<b>Type</b>	<b>Code</b>	<b>Reference</b>	<b>Size</b>	<b>Colour</b>	<b>Qty</b>
E	Shipping	BRT DK1202	717124	2-3/7 x 4"	black on white	300
E	For File Folders	BRT DK1203	717132	2/3 x 3-7/16"	black on white	300
E	Address	BRT DK1201	725598	1-1/7" x 3-1/2"	black on white	400
E		BRT DK1208	717140	1-1/2" x 3-1/2"	black on white	400
E		BRT DK1209	725622	1-1/7" x 2-3/7"	black on white	800
E	Multipurpose	BRT DK1204	725606	2-1/8 x 2/3"	black on white	400
E		BRT DK2210	725630	1-1/7" x 100'	black on white	-
E	Continuous Paper Tape	BRT DK2205	717157	2-3/7" x 100'	black on white	-
E		BRT DK2211	725648	1-1/7" x 50'	black on white	-
E	Continuous Film Tape	BRT DK2212	725663	2-3/7" x 50'	black on white	-
E						
	<b>For QL-1050, 1050N, 1060N</b>					
	<b>Type</b>	<b>Code</b>	<b>Reference</b>	<b>Size</b>	<b>Colour</b>	<b>Qty</b>
F	Multi-Purpose	BRT DK1240	776203	4 x 2"	black on white	600
F	Shipping	BRT DK1241	775825	4 x 6"	black on white	200
F	Continuous Paper Tape	BRT DK2243	775833	4" x 30 m	black on white	-
	<b>For QL800, QL810W, QL820NWB</b>					
	<b>Type</b>	<b>Code</b>	<b>Reference</b>	<b>Size</b>	<b>Colour</b>	
G	Continuous Paper Tape	BRT DK2251	450072	2.4" X 50'	black/red on white	
G	Amovibles	BRT DK3235	829913	1 X 2"	blanc	800

 Please contact customer service or your representative for pricing.

**DYMO**  
and done.

Made of 80% recycled material

**A**  
**D1 Standard Labels**  
For LabelManager™ and LabelWriter® Duo label makers. Adhere to most clean, flat surfaces and feature easy-peel backing for trouble-free application.



	DYMO D1	DYMO D1	DYMO D1	DYMO D1	DYMO D1	DYMO D1	DYMO D1
<b>D1</b>	black on clear	black on white	black on red	black on yellow	black on green	red on white	blue on white
<b>9 MM</b>	DYM 40910 (491431)	DYM 41913 (491423)					
<b>12 MM</b>	DYM 45010 (375592)	DYM 45013 (375600)	DYM 45017 (647503)	DYM 45018 (491407)	DYM 45019 (647347)	DYM 45015 (418202)	DYM 45014 (647354)
<b>12 MM (PKG 2)</b>		DYM 1926208 (366708)					
<b>19 MM</b>		DYM 945803 (491449)					
<b>24 MM</b>		DYM 53713 (193045)					

**B**  
**D1 Durable Labels**  
Industrial-strength adhesive and resist fading, peeling and abrasion due to light, heat, moisture and household cleaners.

	DYMO D1	DYMO D1
<b>D1 DURABLE</b>	black on white	white on black
<b>12 MM (1/2" X 18')</b>	DYM 1978364 (371237)	
<b>12 MM (1/2" X 10')</b>		DYM 1978365 (371245)



**C**  
**LT Labels**  
For Letratag™ label maker. Durable and wipeable. Easy to peel and cut. For indoor use.



	LETRATAG	LETRATAG	LETRATAG	LETRATAG	LETRATAG	LETRATAG
<b>LT</b>	black on clear	black on white	black on red	black on blue	black on yellow	black on silver
<b>12 MM PAPER</b>		DYM 91330 (604553)				
<b>12 MM PLASTIC</b>	DYM 16952 (667394)	DYM 91331 (604546)	DYM 91333 (604579)	DYM 91335 (604587)	DYM 91332 (604561)	
<b>12 MM METAL</b>						DYM 91338 (757245)
<b>12 MM CLOTHING</b>		DYM 18771 (239418)				



**TZE TAPE - FOR P-TOUCH LABEL MAKER. FEATURES AN EXCLUSIVE LAMINATED TAPE PROCESS AND STANDARD ADHESIVE. BEST SUITED FOR SMOOTH FLAT INDOOR OR OUTDOOR SURFACES.**

	BROTHER Tze	BROTHER Tze	BROTHER Tze	BROTHER Tze	BROTHER Tze	BROTHER Tze	Brother Tze
<b>TZE</b>	black on clear	black on white	black on red	black on blue	black on yellow	black on green	black on orange
<b>6 MM</b>	BRT TZE-111 (164731)	BRT TZE-211 (164798)					
<b>9 MM</b>	BRT TZE-121 (164749)	BRT TZE-221 (164806)					
<b>12 MM</b>	BRT TZE-131 (164764)	BRT TZE-231 (164814)	BRT TZE-431 (164996)	BRT TZE-531 (262840)	BRT TZE-631 (164921)	BRT TZE-731 (165019)	
<b>18 MM</b>	BRT TZE-141 (164772)	BRT TZE-241 (164830)			BRT TZE-641 (164939)		BRT TZE-B41 (401828)
<b>24 MM</b>	BRT TZE-151 (164780)	BRT TZE-251 (164863)	BRT TZE-451 (325175)		BRT TZE-651 (164947)		
<b>36 MM</b>		BRT TZE-261 (178996)			BRT TZE-661 (325191)		

**TZE TAPE - FOR P-TOUCH LABEL MAKER. FEATURES AN EXCLUSIVE LAMINATED TAPE PROCESS AND STANDARD ADHESIVE. BEST SUITED FOR SMOOTH FLAT INDOOR OR OUTDOOR SURFACES.**

	BROTHER Tze	BROTHER Tze	BROTHER Tze	BROTHER Tze	BROTHER Tze	BROTHER Tze
<b>TZE</b>	white on clear	red on white	blue on white	gold on black	white on black	white on red
<b>6MM</b>					BRT TZE-315 (564575)	
<b>9 MM</b>		BRT TZE-222 (164954)	BRT TZE-223 (164962)		BRT TZE-325 (164889)	
<b>12 MM</b>	BRT TZE-135 (530592)	BRT TZE-232 (164822)	BRT TZE-233 (164970)	BRT TZE-334 (164897)	BRT TZE-335 (164905)	BRT TZE-435 (178426)
<b>18 MM</b>		BRT TZE-242 (164848)	BRT TZE-243 (164855)		BRT TZE-345 (530600)	
<b>24 MM</b>		BRT TZE-252 (164871)	BRT TZE-253 (164988)			



**TZES TAPE - FOR P-TOUCH LABEL MAKER. FEATURES AN EXCLUSIVE LAMINATED TAPE PROCESS AND EXTRA STRONG ADHESIVE. BEST SUITED FOR SMOOTH FLAT INDOOR OR OUTDOOR SURFACES**

TZES	BROTHER TZES	BROTHER TZES
	black on clear	black on white
<b>9 MM</b>		BRT TZE-S221 (165050)
<b>12 MM</b>	BRT TZE-S131 (165027)	BRT TZE-S231 (165068)
<b>18 MM</b>		BRT TZE-S241 (165076)
<b>24 MM</b>		BRT TZE-S251 (165084)



**MK TAPE - FOR P-TOUCH LABEL MAKER. NON-LAMINATED TAPE. FOR USE ON FLAT, DRY, INDOOR SURFACES**

	BROTHER M	BROTHER M	BROTHER M	BROTHER M
	black on white	black on silver	blue on white	black on yellow
<b>9 MM</b>	BRT MK221 (443408)	BRT M921 (416578)		
<b>12 MM</b>	BRT MK231 (443416)	BRT M931 (416586)	BRT MK233 (668186)	BRT MK631 (668202)



**INDUSTRIAL TAPES. FOR INDOOR OR OUTDOOR USE. BLACK ON WHITE. PACKAGE OF 5.**

	HGE	HGSE
<b>9 MM</b>	BRT HGE2215PK (585190)	
<b>12 MM</b>	BRT HGE2315PK (585208)	BRT HGES2315PK (585232)
<b>18 MM</b>	BRT HGE2415PK (585216)	BRT HGES2415PK (585240)
<b>24 MM</b>	BRT HGE2515PK (585224)	BRT HGES2515PK (585257)

**HSE TAPES - HEAT SHRINK TUBING. BLACK ON WHITE. PACKAGE OF 5.**

<b>5,8 MM</b>	BRT HSE211 (585265)
<b>8,1 MM</b>	BRT HSE221 (585273)
<b>11,7 MM</b>	BRT HSE231 (585281)
<b>17,7 MM</b>	BRT HSE241 (585299)
<b>23,6 MM</b>	BRT HSE251 (585307)



Please contact customer service or your representative for pricing.



**A SHARP**

**EL-2630PIII**  
SHR EL2630PIII (640375)  
• R3027 compatible printing ribbon  
CIG R3027 (259457)



**B SHARP**

**EL-2615PIII**  
SHR EL2615PIII (326967)  
• R3027 compatible printing ribbon  
CIG R3027 (259457)



**C SHARP**

**EL-2607RIII**  
SHR EL2607RIII (724450)  
• R3027 compatible printing ribbon  
CIG R3027 (259457)



**D SHARP**

**EL-2201RII**  
SHR EL2201RII (388637)  
• EA-772R printer ribbon  
SHR EA772R (833324)

Paperless



**E SHARP**

**ELDP9001**  
SHR ELDP9001 (574491)

45% recycled plastic



**F VICTOR**

**1240-3A**  
VCT 1240-3A (777292)  
• R3027 Compatible Printing Ribbon  
CIG R3027 (259457)

MODEL	A. EL-2630PIII	B. EL-2615PIII	C. EL-2607RIII	D. EL-2201RII	E. ELDP9001	F. 1240-3A
SIZE (L X D X H")	9 x 13.2 x 3	8.75 x 12.9 x 3	8.75 x 12.9 x 3	7.6 x 10 x 2.38	7.75 x 9.37 x 2.25	12.75 x 9 x 3.25
NUMBER OF DIGITS	12	12	12	12	12	12
DISPLAY SIZE (MM)	17	12	12	12	12	15
DISPLAY TYPE	fluorescent	fluorescent	fluorescent	fluorescent	LCD	fluorescent
PRINTING SPEED (LPS)	4.8	4.3	4.8	2		4.5
PRINTING TYPE	2 colours	2 colours	2 colours	2 colours		2 colours
COST/SELL/MARGIN KEYS	•	•	•	•	•	•
TAX+ & TAX- KEYS	•	•	•	•	•	•
GRAND TOTAL	•	•	•	•	•	•
DATE/TIME FUNCTION	•	•	•	•		
ANTIMICROBIAL PROTECTION	•	•	•	•		•
MARK-UP KEY (MU)	•	•	•	•		•
4-KEY MEMORY	•	•	•	•	•	•
DOUBLE ZERO KEY "00"	•	•	•	•	•	•
ITEM COUNTER	•	•	•	•		•
POWER SOURCE (MAIN)	AC	AC	AC	AC	AC	AC

45% recycled plastic



## A VICTOR

**1460-4**  
**VCT 1460-4** (777300)  
 • R3027 Compatible Printing Ribbon  
**CIGR3027** (259457)

150% larger print



## B VICTOR

**Big Print 1310**  
**VCT 1310** (117499)  
 • R3027 Compatible Printing Ribbon  
**CIGR3027** (259457)



## C VICTOR

**1297**  
**VCT 1297** (667345)  
 • R1427 Compatible Ink Roller  
**CIG R1427** (259812)

45% recycled plastic



## D VICTOR

**1212-3A**  
**VCT 1212-3A** (100578)  
 • R1427 Compatible Ink Roller  
**CIG R1427** (259812)

20% recycled plastic



## E VICTOR

**1208-2**  
**VCT 1208-2** (610915)  
 • R1427 Compatible Ink Roller  
**CIG R1427** (259812)

25% recycled plastic



## F VICTOR

**1205-4**  
**VCT 1205-4** (193060)  
 • R1180 Compatible Ink Roller  
**CIG R1180** (376293)

MODEL	A. 1460-4	B. Big Print 1310	C. 1297	D. 1212-3A	E. 1208-2	F. 1205-4
SIZE (L X D X H")	12.3 x 8.5 x 3	9.5 x 7.5 x 2.2	11 x 8 x 3	9.5 x 7.5 x 2.5	6 x 7.5 x 1.5	8 x 4 x 1.75
NUMBER OF DIGITS	12	10/12	12	12	12	12
DISPLAY SIZE (MM)	17	15	15	19	15	12
DISPLAY TYPE	fluorescent	fluorescent	fluorescent	LCD	LCD	LCD
PRINTING SPEED (LPS)	4.6	6	4.5	2.7	2.3	2
PRINTING TYPE	2 colours	2 colours	2 colours	2 colours	2 colours	1 colour
COST/SELL/MARGIN KEYS	•	•	•	•	•	•
TAX+ & TAX- KEYS	•	•	•	•	•	•
GRAND TOTAL	•	•	•	•	•	•
DATE/TIME FUNCTION		•	•	•	•	
ANTIMICROBIAL PROTECTION				•		
MARK-UP KEY (MU)						
4-KEY MEMORY	•	•	•	•	•	•
DOUBLE ZERO KEY "00"	•	•	•	•	•	•
ITEM COUNTER	•	•	•	•	•	•
POWER SOURCE (MAIN)	AC	AC	AC	AC/DC	AC/DC	AC/DC



**A Canon**  
**MP-49DII**  
**CNM MP49DII** (269753)  
 • R3027 Compatible Printing Ribbon  
**CIGR3028** (259457)



**B Canon**  
**MP-11DX-2**  
**CNM MP11DX-2** (438895)  
 • R1427 Compatible Ink Roller  
**CIGR1427** (259812)



**C Canon**  
**PID-HV3**  
**CNM PIDHV3** (1043538)  
 • R1486 Compatible Ink Roller  
**CIG R1486** (259861)



**D Canon**  
**P23-DHV3**  
**CNM P23DHV3** (1043520)  
 • R1427 Compatible Ink Roller  
**CIGR1427** (259812)



**E CASIO**  
**HR-200RC**  
**CSO 573329** (573329)  
 • R1427 Compatible Ink Roller  
**CIGR1427** (259812)



**F CASIO**  
**HR-170RC**  
**CSO HR170RC** (597773)  
 • R1427 Compatible Ink Roller  
**CIGR1427** (259812)



**G CASIO**  
**HR-10RC**  
**CSO HR10RC** (573337)  
 • R1180 Compatible Ink Roller  
**CIGR1180** (376293)

MODEL	A. MP-49DII	B. MP-11DX-2	C. PID-HV3	D. P23-DHV3	E. HR-200RC	F. HR-170RC	G. HR-10RC
SIZE (L X D X H")	141 x 89 x 34	12 x 8.2 x 31	4 x 81 x 19	64 x 91 x 2.2	12.3 x 77 x 2.6	64 x 91 x 2.2	8.2 x 4 x 17
NUMBER OF DIGITS	14	12	12	12	12	12	12
DISPLAY SIZE (MM)	14		12	12	20.5	12	12.2
DISPLAY TYPE	fluorescent	LCD	LCD	LCD	LCD	LCD	LCD
PRINTING SPEED (LPS)	4.8	2 / 4.4	2	2.3	2 / 4.4	2.3	2
PRINTING TYPE	2 colours	2 colours	1 colour	2 colours	2 colours	2 colours	1 colour
COST/SELL/MARGIN KEYS	•	•	•	•	•	•	•
TAX+ & TAX- KEYS	•	•	•	•	•	•	•
GRAND TOTAL	•	•	•	•	•	•	•
DATE/TIME FUNCTION	•	•	•	•	•	•	•
ANTIMICROBIAL PROTECTION						•	
MARK-UP KEY (MU)					•	•	•
4-KEY MEMORY	•	•	•	•	•	•	•
DOUBLE ZERO KEY "00"	•	•	•	•	•	•	•
ITEM COUNTER	•	•	•	•	•	•	•
POWER SOURCE (MAIN)	AC	AC	AC	AC/DC	AC	AC	AC



## A TI-84 Plus Graphing Calculator

8 lines x 16 characters display. Advanced statistical and financial functions. Various graphic functions. USB port with link cable included. Battery powered. Sliding case included.  
**TEX TI-84PLUS** (705939)



**A**  **TEXAS INSTRUMENTS**

## B TI-83 Plus Graphing Calculator

8 lines x 16 characters display. Advanced statistical and financial functions. Various graphic functions. I/O port with link cable included. Battery powered. Sliding case included.  
**TEX TI-83PLUS** (500090)

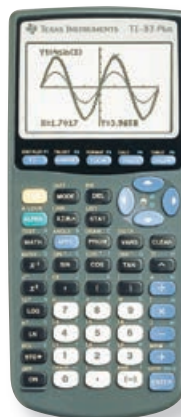

**B**  **TEXAS INSTRUMENTS**

## C BAII Plus Financial Calculator

10-digit display. Convenient calculations such as annuities, mortgages, leases, savings. 4 methods for calculating depreciation. Profit and loss calculation. 2-variable statistics. 10 user memories. Battery powered. Slide case included.  
**TEX BA-IIPLUS** (196568)

## D TI-30X IIS Scientific Calculator

2-line display for entry and calculated result at the same time. View and edit previous entry. 5 variable memories. Trigonometric functions and fractions. Solar and battery powered. Slide case included.  
**TEX TI-30XIIS** (500108)



**C**  **TEXAS INSTRUMENTS**

## E TI-30Xa Scientific Calculator

10 + 2-digit display. Fractions features. One-variable statistics. Conversions. Basic scientific and trigonometric functions. Battery powered. Sliding case included.  
**TEX TI-30XA** (137703)

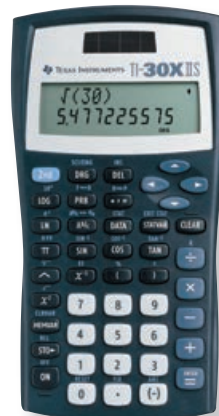

**D**  **TEXAS INSTRUMENTS**

## F EL-738XTB Financial and Scientific Calculator

10-digit + 2 line display. Cost/sell/margin/markup keys. Amortization, compound interest, depreciation, bond calculations. Basic scientific functions. 20 memories. Battery powered. Hard case included.  
**SHR EL738XTB** (598243)

## G EL546XTBSL Scientific Calculator

Large 12-digit, 2-line LCD display. 470 functions. 6 modes: normal, stat, complex, matrix, list, and equation. 8 temporary & 4 formula memory buttons. 1 & 2 variable statistics. Solar and battery powered. Protective hard case.  
**SHR EL546XTBSL** (430686)

## H ELW535XG Scientific Calculator

Large 16-digit, 4-line LCD Display. WRITEVIEW™ display. 422 functions. 3 modes: normal, stat, and drill. 8 temporary & 4 definable memory buttons. 1 & 2 variable statistics. Solar and battery powered. Protective hard case.  
**SHR ELW535XGBW** (516278)

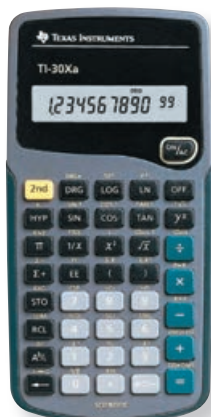

**E**  **TEXAS INSTRUMENTS**

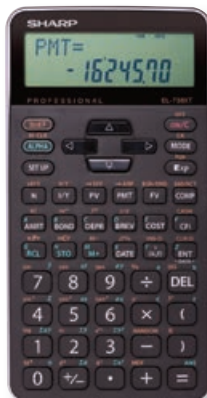

**F** **SHARP**



**G** **SHARP**



**H** **SHARP**



**A SHARP**



**B SHARP**

**A EL520XTBBK Scientific Calculator**

12-digit, 2-line LCD display. 420 functions. 4 modes: normal, stat, complex, and equation. 8 temporary and 4 formula memory buttons. 3 variable linear equation solvers. Solar and battery powered.  
SHR EL520XTBBK (430611)

**B EL531XTBWH Scientific Calculator**

12-digit, 2-line LCD display. 273 functions. 2 modes: normal and stat. 8 temporary memory buttons. 1 and 2 variable statistics. Solar and battery powered.  
SHR EL531XTBWH (430660)

**C EL510RTB Scientific Calculator**

Large 10-digit, 1-line LCD display. 169 functions. 2 modes: normal and stat. Hard case included. Solar and battery powered.  
SHR EL510RTB (574483)

**D FX-991MSPLUS2 Scientific Calculator**

Matrix/Vector calculation. Statistical calculations with STAT-Data Editor. Solve calculations. Equation calculations. Numerical differentiation and integration. 40 scientific constants and 40 metric conversions. Solar and battery powered. Slide-on hard case.  
CSO 587477 (587477)

**E FX-300MSPLUS2 Scientific Calculator**

12-digits, 2-line display. Fraction key for easy entry. 10 memories. Statistical calculations, permutations and combinations, sexagesimal functions, coordinate conversion. Logarithms, exponents and power functions, hyperbolic, constant memories. Solar and battery powered.  
CSO FX300MSPL2 (587493)

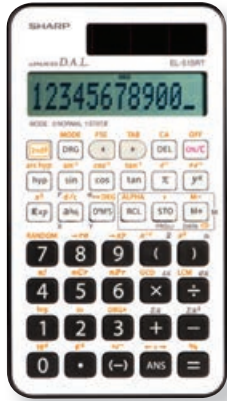

**C SHARP**



**D CASIO**

**F FX-260Solar II Scientific Calculator**

10 + 2-digit LCD display. 144 functions. Single variable statistics. Fractions, Exponential, Scientific notation. Single variable statistics. Permutation, Combination, random number. Trigonometric/inverse functions logarithmic functions. Back space key. Solar powered. Slide-on hard case.  
CSO FX260SOLII (425603)

**G 920 Scientific Calculator**

10-digit display. Simple scientific functions and one-variable statistics functions. Battery powered. Hinged hard cover.  
VCT 920 (528448)



**E CASIO**



**F CASIO**



**G VICTOR**

## A EL-330W Desktop Calculator

10-digit adjustable display. 4-key memory. Tax function. Auto power off. Solar and battery powered. 4 x 6 x 1-1/8".  
SHR EL330WB (432625)

## B EL-334 Desktop Calculator

12-digit display. Cost, sell, margin and find keys. 3-key memory. Solar and battery powered. 6-5/8 x 4-3/4 x 5/8".  
SHR EL334WB (432666)

## C EL-310W Desktop Calculator

8-digit display. Basic functions. 3-key memory. Solar and battery powered. 4-3/4 x 3-3/8 x 7/8".  
SHR EL310WB (432591)

## D TI-1795SV Desktop Calculator

8-digit display. Angled display. 3-key memory. Percentage, square root. Solar and battery powered. 5-1/2 x 4-3/4".  
TEX TI-1795SV (25403)

## E WS-220TSG Desktop Calculator

Large, adjustable tilt LCD display. 12-digits. Tax/Cost/Sell/Margin keys. Decimal positions: + 0, 2, 4, and F. Auto power off. Solar and battery powered. Contains 22% recycled materials. 5-3/4 x 5 x 3/4".  
CNM 9607B001 (277673)

## F LS-100TS Desktop Calculator

10 digit display. Angled LCD display. Tax/Cost/Sell/Margin keys. Square root, sign change and memory keys. Solar and battery powered. Automatic power off. 4.1 x 5.3". 1 year warranty.  
CNM LS100TS (196592)

## G HS20TSC Desktop Calculator

Easy to read 12-digit display. Spaced key pad. Tax calculation. Solar and battery powered. Casing and display made of 100% recycled plastic. 4.1 x 6.4 x 1.2"H.  
CNM HS20TSC (1043512)

## H Offix® D28 Desktop Calculator

12-digit large display. Tilt display. 4-key memory. Solar and battery powered. 5-1/2 x 7-1/2 in.  
MGE 1080910200 (803718)

## I Offix® D18TE Desktop Calculator

12-digit display. Tax calculation. Currency conversion. 3-key memory. Basic functions. Rounding options. Solar and battery powered. 4 x 5-1/4 in.  
MGE 1080911200 (803726)

## J Offix® D25 Desktop Calculator

10-digit jumbo display. 4-key memory. Basic functions. Solar and battery powered. 4 x 5-1/2 in.  
MGE 1080912200 (803700)



**A** SHARP

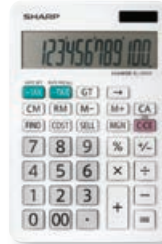

**B** SHARP

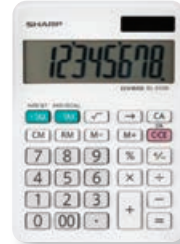

**C** SHARP



**D** TEXAS INSTRUMENTS



**E** Canon



**F** Canon



**G** Canon



**H** offix



**I** offix



**J** offix



**A** CASIO



**B** CASIO



**A DM1200BM Desktop Calculator**

Easy to read 12-digit angled display. Cost-sell-margin-Tax keys. Corrector, decimal selector settings. Solar and battery powered. Metal face plate. 6.1 x 8.2 x 1.4 in H.

**CSO DM1200BM** (1043462)

**B MS80B Desktop Calculator**

8-digit display. +/- sign, square root. Percentage, independent memory, profit margin. Solar and battery powered. 5.8 x 4.1 x 1.1"H.

**CSO MS80B** (529248)

**C Desktop Calculator**

12-digit display. Grand total, mark up, memory, square root, percentage keys. Auto power off. Solar and battery powered. 8 x 5.6 x 1.3"H.

**MGE 1080959100** (564096)

**D CC022BL Desktop Calculator**

8-digit display. 3-key memory. Square root and percentage keys. Dual powered. 6.75 x 3.94 x 0.75"H.

**MGE CC022BL** (546333)

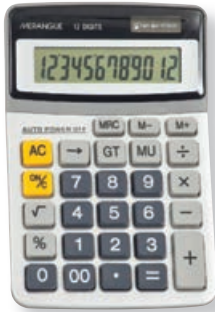

**C** MERANGUE



**D** MERANGUE



**E 9700 Desktop Calculator**

12-digit display. Rounding and decimal switches. Cost, sell, margin and tax keys. Grand total. Solar and battery powered. Uses 1 x 389 battery (included). 2-year warranty. Black. 7-3/4 x 5-11/16 x 1-3/4 in.

**VCT 9700** (793661)

**F 2140 Desktop Calculator**

12-digit display. Rounding and decimal switches. 4-key memory. PC style keys. Grand total. Mark up. Solar and battery powered. 6-1/4 x 7-1/2 x 1-5/8 in.

**VCT 2140** (793620)

**G 1100-3A Desktop Calculator**

Antimicrobial protection. 10-digit angled display. 3-key memory. Square root key. Tax +/- keys. Solar and battery powered. Silver and black. 2-year warranty. 5 x 4-1/2 x 1-1/4 in. Made of 50% recycled plastic.

**VCT 1100-3A** (777276)



**E** VICTOR

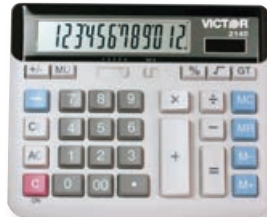

**F** VICTOR



**H 9500 Desktop Calculator**

10-digit angled display. Tax and currency converter. 3-key memory. Rounding selector. Solar and battery powered. 5-1/4 x 4 x 1 in. Made of 50% recycled plastic.

**VCT 9500** (172460)

**I 1000 Desktop Calculator**

8-digit angled display. 3-key memory. Solar and battery powered. Made of 50% recycled plastic. 4-1/4 x 3-1/4 in. 2-year warranty.

**VCT 1000** (793612)



**G** VICTOR



**H** VICTOR



**I** VICTOR



**A EL-244W Pocket Calculator**

8-digit display. Basic functions. 3-key memory. Solar and battery powered. 4 x 2-1/4 x 3/8"H.  
SHR EL244WB (432559)

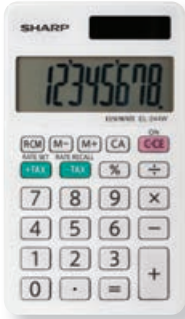

**A SHARP.**



**B SHARP.**

**B EL-377W Pocket Calculator**

10-digit display. 4-key memory. Solar and battery powered. 4-3/4 x 2-5/8 x 3/8"H.  
SHR EL377WB (432674)

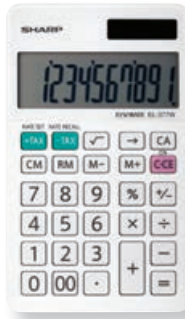

**C EL-243SB Pocket Calculator**

8-digit display. Basic functions. 3-key memory. Solar and battery powered. Integrated hard cover. 4 x 1-1/2 x 3/8"H.  
SHR EL243SB (738328)



**C SHARP.**



**D SHARP.**

**E EL-760R Pocket Calculator**

XL 8 digit display. Inclined display. Tax calculation function. Calculation status display. Round keys. Solar and battery powered. 12.7 x 20 x 3 cm.  
SHR EL760RBMT (1000355) mint and chocolate  
SHR EL760RBLA (1000348) latte  
SHR EL760RBPK (1000330) pink



**F TI503SV Pocket Calculator**

8-digit display. 3-key memory. Percent key, +/- switch key, square root key. Automatic power off. Battery powered. 4.8 x 3.1 x 0.75".  
TEX TI-503SV (529263)



**F TEXAS INSTRUMENTS**

**G Offix® KC370-2 Pocket Calculator**

8-digit display with 3-key memory. Percentage calculation, constant calculation, square root. Solar and battery powered. 2.25 x 3.5 x 3/8"H.  
MGE 1080909200 (803734)

**H 900 Pocket Calculator**

8-digit display. Antimicrobial protection. 3-key memory. Percentage, square root. Solar and battery powered. Hard case. Made of 50% recycled plastic. 4-1/4 x 2 x 1/4"H.  
VCT 900 (500058)

**I 700 Pocket Calculator**

8-digit large display. 3-key memory. +/- key. Solar and battery powered. 4 x 2-1/2 x 1/4".  
VCT 700 (793604)

**J LS-270H Pocket Calculator**

Large, 8-digit display. Basic function keys. 3-digit comma. Memory keys. Auto power off. Solar and battery powered. 2-1/2 x 4 x 1/4"H.  
CNM LS-270H (331223)



**E SHARP.**



**G offix.**



**H VICTOR**



**I VICTOR**



**J Canon**





**A** **GBC**  
**CombBind® C500**  
 GBC 27134 (716100)



**B** **GBC**  
**CombBind® C150**  
 GBC 27110 (247312)



**C** **GBC**  
**CombBind® C110e**  
 GBC 03107 (736702)



**D** **GBC**  
**CombBind® C20**  
 GBC 50004 (138388)



**E** **GBC**  
**CombBind® C12**  
 GBC 70617 (138370)



**F** **GBC**  
**CombBind® Bindmate™**  
 GBC 09578 (1044130)

	MODEL	USAGE	ENVIRONMENT	SIZE	OPERATION	BINDING TYPE	THICKNESS MAX.	PUNCH CAPACITY	WARRANTY (Years)
<b>A</b>	C500	Frequent	Large office	Letter	Manual	CombBind / WireBind	2" (500)	20 sheets	2
<b>B</b>	C150	Moderate	Small office	Letter	Manual	CombBind	2" (500)	20 sheets	2
<b>C</b>	C110e	Moderate	Small office	Letter	Electric	CombBind	1-1/2" (330)	15 sheets	2
<b>D</b>	C20	Moderate	Small office	Letter	Manual	CombBind	1-1/2" (330)	20 sheets	2
<b>E</b>	C12	Moderate	Small office	Letter	Manual	CombBind	1" (225)	12 sheets	2
<b>F</b>	BindMate™	Moderate	Small office	Letter	Manual	CombBind	3/4" (160)	9 sheets	2



**A** **Fellowes**

**Orion™ E 500**  
FEL 5643201 (1044122)

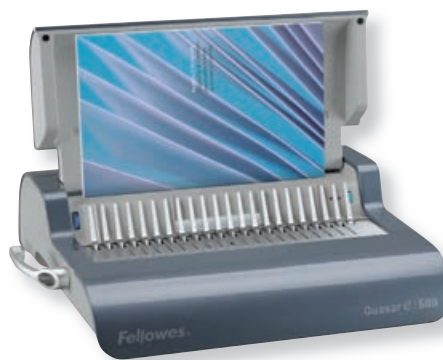

**B** **Fellowes**

**Quasar™ E500**  
FEL 5216901 (777185)



**C** **Fellowes**

**Quasar™+ 500**  
FEL 5227201 (282012)



**D** **Fellowes**

**Pulsar™+ 300**  
FEL 5006801 (281246)



**E** **Fellowes**

**Lyra 3-1**  
FEL 5603001 (804864)

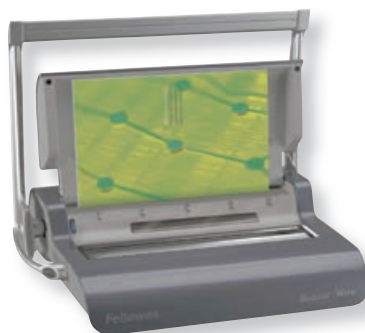

**F** **Fellowes**

**Quasar™**  
FEL 5217401 (800599)



**G** **Fellowes**

**Star™+ 150**  
FEL 5006501 (547406)

	MODEL	USAGE	ENVIRONMENT	SIZE	OPERATION	BINDING TYPE	THICKNESS MAX.	PUNCH CAPACITY	WARRANTY (YEARS)
<b>A</b>	Orion™ E 500	Frequent	Large office	Letter/Legal	Electric	CombBind	2" (500)	30 sheets	1
<b>B</b>	Quasar™ E500	Frequent	Large office	Letter	Electric	CombBind	2" (500)	25 sheets	2
<b>C</b>	Quasar™+ 500	Frequent	Large office	Letter	Manual	CombBind	2" (500)	25 sheets	2
<b>D</b>	Pulsar™+ 300	Moderate	Small office	Letter	Manual	CombBind	1-1/2" (300)	20 sheets	2
<b>E</b>	LYRA 3-1	Moderate	Small office	Letter	Manual	CombBind	5/8" (120)	12 sheets	2
<b>F</b>	Quasar™	Moderate	Small office	Letter	Manual	WireBind	9/16" (130)	15 sheets	2
<b>G</b>	Star™+ 150	Moderate	Small office	Letter	Manual	CombBind	3/4" (150)	15 Sheets	2



**A** GBC



**B** GBC

**A Clear View® Binding Covers**

Clear durable plastic. Letter size. 8-3/4 x 11-1/4 in. Rounded corners. 7 mil thickness. Box of 100.  
**GBC 00158** (398594)

**B Clear View® Binding Covers**

Clear durable plastic. Letter size. Square corners. 7 mil thickness.  
**8-3/4 x 11-1/4 in. (rounded corners) - package of 25**  
**GBC 00260** (521435)  
**8-1/2 x 11 in. (square corners) - box of 100**  
**GBC 00159** (100776)

**C Recycled Poly Binding Covers**

Durable poly material. Letter size. 8-1/2 x 11 in. Square corners. 16 mil thickness. Package of 25. 100% post-consumer recycled content.  
**GBC 25817** (560177) frosted  
**GBC 25818** (560185) black



**C** GBC



**D Linen Weave® Binding Covers**

Linen textured paper. Letter size. 8-3/4 x 11-1/4 in. Rounded corners. Box of 200. 50% recycled content, 30% post-consumer.

**Package of 50**  
**GBC 01813** (1044189) navy  
**GBC 02059** (1044171) black  
**Box of 200**  
**GBC 00182** (701276) navy  
**GBC 08200** (777094) black

**E Solids Standard Binding Covers**

Heavy-duty, opaque plastic covers are spill and tear proof. Letter size, 8-3/4 x 11-1/4 in. Rounded corners. 13-1/2 mil thickness. Package of 25. Blue.  
**GBC 25730** (560169)

**F CombBind® Binding Combs**

Compatible with most plastic comb binding systems. Letter size. Box of 100. Black.  
**GBC00953** (398495) 1/4 in. (cap. 25 sheets)  
**GBC 00967** (398511) 3/8 in. (cap. 60 sheets)  
**GBC 00981** (398537) 1/2 in. (cap. 90 sheets)  
**GBC00992** (687285) 5/8 in. (cap. 130 sheets)  
**GBC 00997** (401794) 3/4 in. (cap. 160 sheets)  
**GBC01007** (401844) 1 in. (cap. 200 sheets)  
**GBC 01423** (232645) 1-1/2 in. (cap. 330 sheets)



**D** GBC



**G Large Capacity CombBind® Binding Combs**

Compatible with most plastic comb binding systems. Letter size. 2 in, 500 sheet capacity. Box of 50. Black.  
**GBC 01433** (232264)

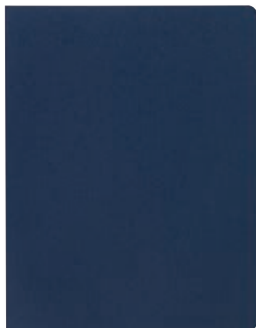

**E** GBC



**F** GBC



**G** GBC



## A Transparent PVC Binding Covers

Clear durable plastic. Letter size, 8-1/2 x 11 in. Square corners. 8 mil thickness. Box of 100.  
**FEL 52089** (281261)



**A** **Fellowes**

## B Transparent PVC Binding Covers

Clear durable plastic. Oversized letter size, 8-3/4 x 11-1/4 in. Rounded corners. 8 mil thickness. Box of 100.  
**FEL 52311** (281253)



**B** **Fellowes**

## C Futura™ Binding Covers

Premium heavyweight material. Letter size, 8-1/2 x 11. Square corners. 14 mil thickness. Package of 25. Black.  
**FEL 5224901** (1044270)

## D Futura™ Binding Cover

Premium heavyweight material. Oversized letter size, 8-3/4 x 11-1/4 in. Rounded corners. 14 mil thickness. Package of 25. Noir.  
**FEL 5224701** (281279)

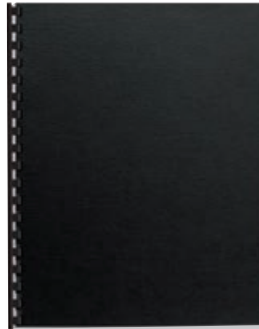

**C** **Fellowes**



**D** **Fellowes**

## E Linen Textured Binding Covers

Premium, heavy gauge cover with linen-textured finish. Oversized letter size, 8-3/4 x 11-1/4 in. Rounded corners. 65 lb thickness. Box of 200.  
**FEL52115** (281287) black  
**FEL 52113** (281295) navy

## F Binding Comb

Compatible with most plastic comb binding systems. Letter size. Package of 100, except 1-1/2 in (package of 50).

### White

**FEL 52370** (281303) 1/4 in. (cap. 20 sheets)  
**FEL5233001** (547422) 5/16 in. (cap. 40 sheets)  
**FEL 52371** (281337) 3/8 in. (cap. 55 sheets)  
**FEL 52372** (281329) 1/2 in. (cap. 90 sheets)

### Black

**FEL 52366** (281311) 1/4 in. (cap. 20 sheets)  
**FEL52507** (547414) 5/16 in. (cap. 40 sheets)  
**FEL52325** (281345) 3/8 in. (cap. 55 sheets)  
**FEL 52326** (281352) 1/2 in. (cap. 90 sheets)  
**FEL 52327** (281360) 5/8 in. (cap. 120 sheets)  
**FEL 52367** (281378) 3/4 in. (cap. 150 sheets)  
**FEL 5232801** (281386) 1 in. (cap. 200 sheets)  
**FEL 52368** (281394) 1-1/2 in. (cap. 340 sheets)

### Navy

**FEL 5233901** (388124) 1/4 in. (cap. 20 sheets)  
**FEL52505** (547430) 3/8 in. (cap. 55 sheets)  
**FEL 52501** (547448) 1/2 in. (cap. 90 sheets)



**E** **Fellowes**



## G Metal Wire Binding Combs

Gives a professional appearance to bound documents. Secure closure permanently binds documents. Compatible with most wire-binding systems (3:1 punching pitch and 32-hole pattern). Box of 25. Black.

**FEL 52539** (562835) 1/4 in. (cap. 35 sheets)  
**FEL52541** (562843) 3/8 in. (cap. 80 sheets)

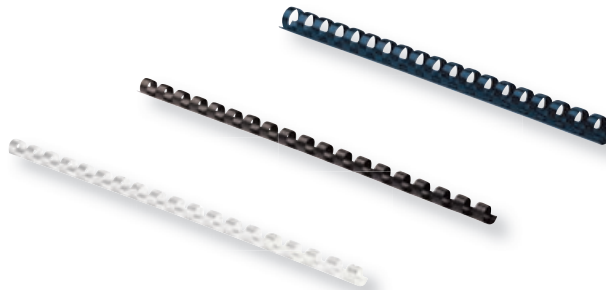

**F** **Fellowes**



**G** **Fellowes**

# The Fastest Way to Perfect Lamination



## LX SERIES

Fellowes's new LX Series office laminators have faster than ever document finishing speeds. These innovative machines are thoughtfully designed and have patented technology to produce perfect and hassle-free results from start to finish.



InstaHeat



AutoSense



Jam Free

Work Better. Feel Better.™

**Fellowes**

# Laminating Machines and Accessories | Office Machines



**N**  
2023

**A** **Fellowes**

**Jupiter™ 125**  
FEL5746301 (827982)



**N**  
2023

**B** **Fellowes**

**Venus™ 125**  
FEL5746101 (827983)



**N**  
2023

**C** **Fellowes**

**Amaris™ 125**  
FEL8058101 (827984)



**D** **Fellowes**

**Callisto™ 125**  
FEL 5729101 (306902)



**E** **Fellowes**

**Saturn™ 3i 125**  
FEL 5736601 (569905)



**F** **Fellowes**

**Callisto™ 95**  
FEL 5728401 (1044627)



**G** **Fellowes**

**Saturn™ 3i 95**  
FEL 5735801 (281410)



**H** **Fellowes**

**Halo™ 125**  
FEL 5753101 (804857)



**I** **Fellowes**

**Halo™ 95**  
FEL 5753001 (804849)



**J** **Fellowes**

**Spectra™ 95**  
FEL 5738201 (524587)

	MODEL	USAGE	ENVIRONMENT	OPENING WIDTH	FILM	POUCH THICKNESS (mil)	SPEED (" /min.)	WARM UP	AUTO SHUT OFF	ANTI-JAM	WARRANTY (YEARS)
A	Jupiter 125	Frequent	Large office	12.5"	pouch	up to 10 mil	55	1 min.	•	•	2
B	Venus 125	Frequent	Large office	12.5"	pouch	up to 10 mil	86	30 sec	•	•	2
C	Aramus	Moderate	Small Office	12.5"	pouch	up to 7 mil	31	1 min.	•	•	2
D	Callisto™ 125	Moderate	Small Office	12.5"	pouch	up to 5 mil	19	1 min.	•	•	2
E	Saturn™ 3i 125	Moderate	Small Office	12.5"	pouch	up to 5 mil	12	1 min.	•	•	2
F	Callisto™ 95	Moderate	Small Office	9.5"	pouch	up to 5 mil	19	1 min.	•	•	2
G	Saturn™ 3i 95	Moderate	Small Office	9.5"	pouch	up to 5 mil	12	1 min.	•	•	2
H	Halo™ 125	Occasional	Personal	12.5"	pouch	up to 5 mil	12	1 min.	•	•	2
I	Halo™ 95	Occasional	Personal	9.5"	pouch	up to 5 mil	12	1 min.	•	•	2
J	Spectra™ 95	Occasional	Personal	9.5"	pouch	up to 5 mil	12	4 min.	•	•	2

**A** **GBC**

**Ultima 35**  
GBC 05451 (757732)



**B** **GBC**

**Fusion™ Plus 7000L**  
GBC 50262 (441048)



**C** **GBC**

**Fusion™ Plus 6000L**  
GBC 50261 (1044361)



**D** **GBC**

**Fusion™ 3100L**  
GBC 50028 (194274)



**E** **GBC**

**Fusion™ 3000L**  
GBC 50027 (194266)



**F** **GBC**

**Fusion™ 1100L**  
GBC 50026 (194258)



**G** **GBC**

**Inspire Plus**  
SWI 70185 (550731)



**H** **3M**

**LS-950**  
MMM LS950 (495010)



**I** **3M**

**LS-1000**  
MMM LS1000 (601385)



**J** **Scotch**

**TL902-C**  
MMM TL902-C (806430)



	MODEL	USAGE	ENVIRONNEMENT	OPENING WIDTH	FILM	POUCH THICKNESS (mil)	SPEED (" /min.)	WARM UP	AUTO SHUT OFF	ANTI-JAM	WARRANTY (YEARS)
A	Ultima 35	Frequent	Commercial	12-1/2"	roll	17 to 5	36	1 min	•		2
B	Fusion™ Plus 7000L	Frequent	Medium office	12"	pouch	1.5 to 10	55	1 min.	•	•	3
C	Fusion™ Plus 6000L	Moderate	Medium office	12"	pouch	3 to 10	47	1 min.	•	•	3
D	Fusion™ 3100L	Moderate	Medium office	12"	pouch	3 to 7	31.5	1 min.	•	•	3
E	Fusion™ 3000L	Moderate	Medium office	12"	pouch	3 to 5	19	1 min.	•	•	2
F	Fusion™ 1100L	Occasional	Small office	9"	pouch	3 to 5	13	3 mins.	•	•	3
G	Inspire Plus	Occasional	Personal	9"	pouch	3 to 5	9	4-5 mins.		•	3 months
H	LS-950	Occasional	Personal	8.5"	roll	2,6	manual				1
I	LS-1000	Occasional	Personal	12.5"	roll	2,6	manual				1
J	TL-902C	Occasional	Personal	9"	pouch	3 to 5	15"	1 min	•		1

## A ImageLast Thermal Laminating Pouches

With built-in UV protection prevent fading. 9 x 11-1/2 in.  
For letter size documents.

- 3 mil.
- FEL 5200501 (458547) pkg 25
- FEL 52225 (281428) box 50
- FEL 52454 (281436) box 100
- FEL 5244101 (281451) box 200
- 5 mil.
- FEL52040 (281444) box 100
- FEL 5245301 (547463) pkg 200



A



B

## B Thermal Laminating Pouches

9 x 11-1/2 in. For letter size documents.

- 3 mil.
- FEL 5744301 (806810) pkg 50
- FEL 5743301 (806828) pkg 100
- FEL 5743401 (806836) pkg 200
- 5 mil.
- FEL 5743501 (806844) pkg 100

## C Thermal Laminating Pouches

9 x 14-1/2 in. For legal size documents.

- 3 mil.
- FEL 52006 (458315) pkg 25
- FEL 52226 (281469) box 50
- 5 mil.
- FEL 52045 (281493) box 100



C



D

## D Lamination Pouches

11-1/2 x 17-1/2 in. For menu or tabloid size documents

- 3 mil.
- FEL 52011 (524561) pkg 25
- FEL 52013 (281477) box 50
- 5 mil.
- FEL 5746001 (806802) pkg 100

## E Thermal Laminating Pouches

2-1/4 x 3-3/4 po. For business cards. 5 mil. Package of 100.

- FEL 52031 (281485)

## F Thermal Laminating Pouches

2-5/8 x 3-7/8 in. For I.D. card. 5 mil

- FEL 52007 (806852) pkg 25
- FEL 52015 (806869) pkg 100

## G Thermal Laminating Pouches

4-1/2 x 6-1/4 in. For photos. Package of 25.

- FEL 5208301 (1044460) 3 mil
- FEL 52010 (1044486) 5 mil

## H Thermal Laminating Starter Kit

Kit includes 60 letter size pouches, 10 luggage tag pouches with loop, 30 photo pouches, and 30 business card pouches. 3 mil. Package of 130.

- FEL 5208502 (1044478)

## I Laminating Supply And Care Kit

Laminating supplies for 100 documents and cleaning sheets.  
Kit includes 25 x 3 mil letter laminating pouches, 25 x 3 mil legal laminating pouches, 25 x 3 mil menu laminating pouches, 25 x 5 mil business card laminating pouches, and 10 packs of laminator cleaning sheets.

- FEL 5221701 (306985)

## J Laminator Cleaning Sheets

Removes roller residue after usage and keep the hot laminating roller clean. Extends laminator lifespan. Package of 10.

- FEL 5320603 (281501)



E



F



G



H



I



J



**A**



**B**



**C**

**A UltraClear™ Laminating Pouches**

9 x 11-1/2 in. For letter size documents.  
**3 mil**  
**GBC 02878** (116558) box 100  
**GBC 04131** (169821) pkg 50  
**5 mil.**  
**GBC 02460** (116541) box 100

**B UltraClear™ Laminating Pouches**

11-1/2 x 9 po. For letter size landscape documents.  
 Box of 100.  
**GBC02087** (401208) 3 mil  
**GBC 02088** (401216) 5 mil

**C UltraClear™ Laminating Pouches**

9 x 14-1/2 in. For legal size documents.  
**3 mil.**  
**GBC 59003** (169813) pkg 50  
**GBC 02880** (401232) box 100  
**5 mil.**  
**GBC 02099** (401240) box 100

**D UltraClear™ Laminating Pouches**

11-1/2 x 17-1/2 in. For menu or tabloid size documents.  
**3 mil.**  
**GBC 6447402037** (282038) pkg 25  
**GBC 50123** (232397) pkg 50  
**5 mil.**  
**GBC 02100** (401265) box 100

**E UltraClear™ Laminating Pouches**

2.2 x 3.7 in. For business cards. 5 mil. Box of 100.  
**GBC 51005** (488569)

**F UltraClear™ Laminating Pouches**

2.6 x 3.9 po. For I.D. card.  
**5 mil.**  
**GBC 6447402109** (232678) pkg 25 (with clip)  
**GBC 56005** (491100) box 100  
**7 mil.**  
**GBC 00893** (401299) box 100

**G UltraClear™ Laminating Pouches**

2.3 x 4.3 in. Luggage tag with loop. 5 mil. Package of 25.  
**GBC 6447402043** (282046)

**H EZUse™ Laminating Pouches**

Provides outstanding lamination accuracy and UV protection. The helpful EZUse alignment guides, mil thickness icon and directional arrow on every pouch simplify the laminating process  
**3 mil. (package of 100)**  
**GBC 20051** (453241) 9 x 11-1/2 in.  
**5 mil. (package of 100)**  
**GBC 20052** (453258) 9 x 11-1/2 in.  
**GBC 03222** (453274) 9 x 14-1/2 in.  
**GBC 03223** (454041) 11-1/2 x 17-1/2 in.  
**10 mil. (package of 50)**  
**GBC 02391** (244111) 11-1/2 x 9 in.

**I SelfSeal™ Self-Adhesive Pouches**

For heat sensitive materials. Just peel and seal, no machine required. Package of 10.  
**2-3/8 x 3-7/8 in. - 8 mil**  
**GBC 6447405006** (268177)  
**9 x 12 in. - 3 mil**  
**GBC 3381605056** (169839)

**J NoMistakes™ Self-Adhesive Pouches**

Seal is not permanent for 24 hours to allow for repositioning. Just peel and seal, no machine required. 11-9/16 x 9-1/6 in. For letter size documents. 8 mil. Package of 5.  
**GBC 6447406563** (268193)

**K Laminator Cleaning Sheets**

Helps maintain peak performance of your laminator. 2-in-1 design can also be used as a pouch carrier. Package of 5.  
**GBC 11258** (194399) letter/legal



**D**



**E**



**F**



**G**



**H**



**I**



**J**

Repositionable for 24 hrs

**K**



## A Thermal Laminating Pouches

Compatible with most laminating machines.  
**3 mil (box of 100)**  
**BSN 20863** (1044767) 9 x 11-1/2 in. (ultra brilliant)  
**BSN 20869** (1044726) 9 x 14-1/2 in.  
**3 mil (box of 200)**  
**BSN 20847** (1044692) 9 x 11-1/2 in.  
**5 mil (box of 50)**  
**BSN 20856** (1044585) 12-1/8 x 18 in.  
**5 mil (box of 100)**  
**BSN 20861** (1044601) 2-1/4 x 3-3/4 in.  
**BSN 20852** (1044494) 2-15/16 x 4-1/8 in.  
**BSN 20862** (1044775) 9 x 11-1/2 in. (econo)  
**BSN 20864** (1044783) 9 x 11-1/2 in.  
**BSN 20867** (1044734) 9 x 14-1/2 in.  
**BSN 20868** (1044750) 11-1/2 x 17-1/2 in.  
**5 mil (box of 200)**  
**BSN 20849** (1044718) 9 x 11-1/2 in.  
**10 mil (box of 50)**  
**BSN 20846** (1044684) 9 x 11-1/2 in.



## B Offix® Laminating Pouches

Letter size, 11-1/2 x 9".  
**3 mil**  
**NVX 579128** (579128) pkg 50  
**NVX 579110** (579110) pkg 100  
**5 mil**  
**NVX 579136** (579136) pkg 50  
**NVX 579144** (579144) pkg 100



## C Thermal Laminating Pouches

High gloss finish. Package of 25.  
**3 mil**  
**RSI 03LETR0025** (564658) 8-3/4 x 11-1/4 in.  
**RSI 03LEGL0025** (1044395) 9 x 14-1/2 in.  
**5 mil**  
**RSI 054X6C0025** (1044379) 4-3/8 x 6-1/2 in.

## D Luggage Tag with Loop

Thermal laminating pouches 5 mil. 2-1/2x 4-1/4 in. Package of 25.  
**RSI 05LUGL0025** (1044676)



## E Self-Sealing Laminating Pouches

For heat sensitive materials. Just peel and seal, no machine required.  
 2.4 in x 3.8 in. Package of 25.  
**2 x 3-1/2 in.**  
**MMM LS851-10C** (1044510) pkg 10  
**MMMLS851GC** (829014) pkg 25  
**9-1/2 x 13-1/5 in.**  
**MMM LS854-10C** (1044528) pkg 10

## F Thermal Laminating Pouches

Pouches are clear with a professional finish. Photo Safe. 3 mil.  
 Letter size, for items up to 8-1/2 x 11 in. Package of 50.  
**MMM 529594** (529594)

## G EZ Load Film Roll

For Ultima 35 laminating machine. 12 in. wide. 1 in. core.  
 Clear and glossy. Box of 2.  
**GBC 3381605639** (757740) 300 ft. (1.7 mil)  
**GBC 05641** (757757) 200 ft. (3 mil)  
**GBC 3381605642** (757765) 100 ft. (5 mil)



## H Laminating Roll Film

For Pinnacle 27 laminating machine. 25 in. wide. 3 mil. Box of 2.  
**GBC 05828** (1044437) 250 ft.  
**GBC3381630055** (1072198) 500 ft.

## I Polyester Laminating Film

Glossy. Designed for laminating all types of low-heat output.  
 27 in. x 500 ft. 1.5 mil. Box of 2.  
**RSI 0152705001** (1044453)

## J Lamination Refill Roll

For use with LS series laminators.  
**DL951- 8-1/2 in. x 100 ft. (for LS950)**  
**MMM DL951** (495028)  
**DL1001 - 12 in. x 100 ft. (for LS100)**  
**MMM DL1001** (601401)





**A Pocket Memo 6700 Digital Recorder/Transcriber**  
 High recording quality in DSS and MP3 files. Two microphones for superior audio recordings. Push-button recording control. Large colour display and intuitive user interface. Ergonomic foot pedal for playback control. Stereo headphones. USB file download. SpeechExec software. High capacity Li-ion battery.  
**PSP DPM6700/03** (246041)

**B Pocket Memo 6000 Digital Recorder**  
 High recording quality in DSS and MP3 files. Two microphones for superior audio recordings. Push-button recording control. Large colour display and intuitive user interface. High capacity Li-ion battery. USB.  
**PSP DPM6000/01** (246033)

**A PHILIPS**



**C DVT2110 VoiceTracer Digital Recorder**  
 Ideal for documenting your important conversations and interviews. Features a high-end 3 microphone system for ultra-clear audio. The ideal note-taking device with a simple, clean and intuitive user interface, colour display and function keys. 8 GB internal memory for up to 88 days of recording. Calendar search. Stereo MP3 recording. MicroSD card slot. Li-polymer built-in battery. USB-C.  
**PSP DVT2110/00** (597047)

**D DVT2050 VoiceTracer Digital Recorder**  
 Voice activated recording. Two microphones. 8 GB internal memory for up to 88 days of recording. Time-stamped recording. Large colour display. Stereo MP3 recording. Calendar search. MicroSD card slot. Includes 2 AAA batteries. USB.  
**PSP DVT2050/00** (597070)

**E WS-853 Digital Recorder**  
 The Intelligent Auto Mode automatically adjusts the microphone sensitivity according to the volume of the sound source. PCM/MP3/WMA stereo recording. Music player. 8 Gb for 2,000 hours of recording time. microSD card slot. USB direct connector, no cable needed. 5 folders, 200 messages per folder. Calendar search function. Auto scene adjustment. Up to 99 index marks. Powered by one AAA battery.  
**OLY 367771** (367771)



**B PHILIPS**



**C PHILIPS**



**D PHILIPS**



**E OLYMPUS**



**F AS-2400 Digital Transcriber**  
 Simple user interface. 3-button USB foot pedal to control the DSS Player Standard software. Lightweight (28g) E 102 stereo under the chin head phone. Playback of several audio codecs. (DSSPro, DSS, WAV, WMA, MP3). Includes foot pedal, software and head phone. 1-year limited warranty.  
**OLY 147588** (109405)  
 • Replacement headset  
**GRN SPECTRA-PC** (563452)

**G LFH-0233 Replacement Headset**  
 Y-style headphone with padded ear cushions. Compatible with all Philips desktop dictation and transcription systems.  
**PSP ACC0233** (278937)

**F OLYMPUS**



**G PHILIPS**





## A CA-95 Value-Plus Bill Counter

Designed for retail applications, it offers all the features allowing the user to carry out all necessary functions to manage the money counts including: auto start /stop, automatic or manual batch selections, add function, and also a UV detection system for bank notes.

**EGDCA-95** (829506)

## B CA-250 Bill Counter

Sort 1,200 bills per minute. Addition and variable batch (1-999) calculation functions. 360° rotary display. Counterfeit detection via UV technology. Detects half-bills and double-bills. Feed capacity of 250 bills at a time. Red LED display. Auto start/stop. AC powered.

**EGD CA-250** (281238)

## C RBC-ES210 Bill Counter

Counts over 1,100 bills per minute. Back-loading collection opening holds up to 130 bills. Works with both paper and new Canadian polymer bank notes. Automatic start. Can count in batches of 1 - 999. Add mode shows cumulative total of all bills counted. External display included.

**RSI RBCE210CA** (587964)

- **Cleaning cards - package of 15**
- RSI RBC-CLN** (1044031)

## D Electric Bill Counter

Side-loading. Counterfeit detection for cash, IDs and documents. Lightweight for easy portable use. Fast operation counts up to 600 bills per minute. 150 bill capacity.

**RSI RBC-QUICK** (1044023)

## E PL-9 Counterfeit Detector

Powerful 9 watt bulb. Compact and ergonomic design. Using ultraviolet technology, it verifies the authenticity of banknotes, credit cards, traveler's cheques and passports. Works with Canadian, American and more than 105 other currencies around the world.

**EGD PL-9WATT** (759977)

- **Replacement bulb**
- EGD PL-9ND** (766691)

## F SM-80 Coin Counter/Sorter

For coin counting and sorting. You can set a specific number of coins per tray to make money rolls. Speed of 200 coins per minute. Feed capacity of 500 coins. Programmable batching. For Canadian market only.

**EGD SM-80** (794594)

- **Coin roller adapter kit**
- EGD SM80ENCKIT** (805649)

## G FS2D Digital Coin Sorter

Counts money by using the 2 row digital coin sorter. Digital display screen shows the dollar value and number of coins counted. Speed of 80 coins per minute. Anti-jam technology. For Canadian 1¢, 5¢, 10¢, 25¢, \$1 and \$2.

**RSI FS2D-CA-N** (321372)



**A ACCU\$UM**



**B ACCU\$UM**



**C RS Royal Sovereign**

**D RS Royal Sovereign**



**E ACCU\$OLLAR**

**F ACCU\$UM**

**G RS Royal Sovereign**



**A** **MasterLock**



**B** **Winnable**

**A MasterLock Storage Bag**

Safely carry cash, jewelry and confidential documents. Water resistant nylon. Nylon reinforced seams. Identification card holder. Built-in high security lock. 10 x 8 x 1 in. Blue.  
**MLK 7120D** (828058)

**B Wide Security Bag**

Tamper evident and waterproof. Locking zipper closure. Reusable. 18 x 14 x 4 in. Blue.  
**WNN 81009** (574160)

**C Security Bag**

Tamper evident and waterproof. Locking zipper closure. Reusable. 18 x 12 in. Blue.  
**WNN 81005** (574152)

**D Security Bag With Eyelet**

Tamper evident and waterproof. Locking zipper closure. Reusable. 10 x 10 in. Blue.  
**WNN 81001** (574145)



**C** **Winnable**



**D** **Winnable**

**E Deposit Bag**

Heavy-duty nylon bag, with wrist loop. Reusable and resistant to repeated use. 12 x 9 in. Blue.  
**WNN 81010** (574186)

**F Locking All-Purpose Pouch**

Heavy-duty canvas material. Ideal for securing items. Includes brass padlock with 3 keys. 13.4 x 10 in. Blue.  
**MGE BP945BBBLUE** (525741)

**G All Purpose Pouch**

Heavy-duty ballistic nylon construction with easy carry wrist strap. Ideal for your bank deposits. 11.5 x 9 in. Black.  
**MGE BP331B** (525733)

**H Security Bag Seals**

Numbered seals for security bags. Package of 100. Blue.  
**WNN 82100** (574178)



**E** **Winnable**



**F** **MERANGUE**



**G** **MERANGUE**

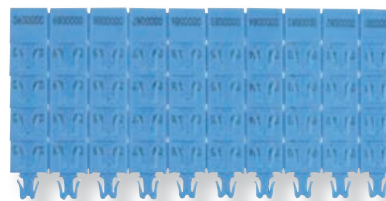

**H** **Winnable**



## A Fire and Water Resistant Bag

Tested to endure brief fire exposure and keep interior temperatures safe for irreplaceable documents, cash, and small valuables. Sturdy, 4-layer protection includes a silicon-coated fiberglass exterior and an aluminized fiberglass interior to stand up against unexpected fire and water threats. Dual closure includes snaps and a zipper for added protection. 11 x 1.5 x 15 in. Grey and black.  
**SEN FBWLZ0SSC** (828059)



## B Tamperproof Bags

Tamper-evident top closure shows you if it's been altered in any way. Tear-off receipt provides convenient way to keep track of all bags. Exterior is bar-coded and numbered for quick identification. Versatile information area can be written on or affixed with label. 12 x 9 in. Package of 50.  
**MGE 10084192** (1044007)



## C All Purpose Pouch

Heavy-duty ballistic nylon construction. Ideal for carrying money, stationery, coins and similar items. 6 x 10-1/4 in. Black.  
**MGE BP0798B** (525725)



## D Clear All-Purpose Pouch

Heavy duty vinyl pouch. Ideal storage pouch for cash, collectables, and small items. 0.59 x 5.91 x 11.42 in.  
**MGE BP0098B** (1045146)



## E Coin Roller

For Canadian coins. Package of 10.

**BFO 16001** (585984) 5 ¢

**BFO 16002** (585992) 10 ¢

**BFO 16003** (586008) 25 ¢

**BFO 16004** (586016) \$ 1.00

**BFO 16005** (586024) \$ 2.00

## F Paper Coin Tube

Package of 36.

**MGE 38829** (829339) 5 ¢

**MGE 38831** (829340) 10 ¢

**MGE 38832** (829341) 25 ¢

**MGE 38833** (829342) \$ 1.00

**MGE 38834** (829343) \$ 2.00

**MGE 617036** (829344) assorted

## G Duplicate Petty Cash Book

Designed for cash payouts. 4 receipts per page. 2-part carbonless paper for automatic sets. White/ canary paper sequence. Wire bound book opens perfectly flat. Detached form size: 2.75 x 5 in.  
**TOP 4109** (1043801)





**A** **SentrySafe**



**B** **Royal Sovereign**

**A Steel Cash Box**

A convenient fold away carrying handle and a removable cash drawer makes this safe ideal for your home and business needs.  
2 lb. 7.9 x 6.1 x 3.3 in. Black.  
**SEN CB8SSC** (828057)

**B Lift Tray Lockable Cash Box**

Solid steel. Five compartment tiered coin tray that lift automatically when cover is open. Separate storage underneath for spare rolls. Four bill compartments. with spring bill retainers. Security lock with two keys. Carry handle. 11.8 x 10 x 4 in. H. Charcoal grey.  
**RSI CMCB-400** (1043330)

**C Cash Box With Latch Lock**

7 compartments. Latch lock (2 keys included). Metal. 11 x 7-3/4 x 3.9 in. H. Grey.  
**RSI CMCB-280LL** (1043348)

**D CB-12 Safebox**

Privacy key lock. Convenient fold-away handle. 8-compartment removable tray. Rounded corners. 11-13/16 x 9-1/4 x 3-5/8 in. H. Black.  
**SEN CB-12** (246074)



**C** **Royal Sovereign**



**D** **SentrySafe**

**E Drawer Safe**

Equipped with a removable cash drawer to keep your cash, coins, checks and receipts organized. Private key lock. Comes with mounting hardware to prevent unauthorized removal. Ext: 6.7 x 7.1 x 2.1 in. H. Int: 6.5 x 6.8 x 1.6 in. H.  
**SEN DS-1** (527267)

**F CB-10 Safebox**

Key lock. Convenient fold-away handle. Removable tray with 6 compartments. Rounded corners. 9.8 x 7.4 x 3.3 in. H. Black.  
**SEN CB-10** (544924)

**G Offix® Cash Box With Tray**

7 compartments. Universal lock. Metal. 11 x 7-3/4 x 4 in. H. Sand.  
**NVX 344523** (344523)



**E** **SentrySafe**



**F** **SentrySafe**

**H Cash Drawer**

Heavy-duty steel construction. One touch manual operation. Adjustable plastic tray with 4 bill compartments and 8 coin dividers. Dual media slots securely stores POS tender. Black.  
**RSI RCRD-1616M** (369280) key lock  
**RSI RCRD1616UE** (450098) USB connectivity  
• **Tray lid with lock**  
**RSI RCRD-16T** (369264)  
• **Mounting brackets - package of 2**  
**RSI RCRD-MB** (1073881)

Find Fireproof Cash Boxes and Safes on **pages 215-217**



**G** **offix**



**H** **Royal Sovereign**

## A LT5000 Manual Time Clock

2-line printing. Operates as document stamp, time clock or numbering machine. Custom text printing along with date and time. LCD display (time and date). 29 standard time and date formats. 15 preset text comments. 4 individual counters, 8 digits per counter, up to 9 repeats. 7 languages.

LTH LT5000 (371898)



## B 1600E Time Clock

Wireless time synchronization to an atomic clock. Automatically adjusts for daylight saving time. Records employees in and out times for payroll accounting. Can be used as a document stamp to print preset messages on important documents.

LTH 1600E (353524)

• Time cards - package fo 100

LTH E16-100 (1044859)

• Replacement ribbon

LTH VIS6008 (664979)



## C 2100HD Thermal Print Time Clock

Heavy duty steel and ABS construction. SmartClock™ technology with perpetual calendar retains time, date and settings during power outages, and auto-adjusts for Daylight Saving Time and Leap Years. Automatic print activation for simple one-hand operation. Offers a variety of print formats. Super large, high-contrast LCD display. Trilingual.

LTH 2100HD (573394)

• Time cards - package fo 100

LTH E8-100 (172445) English

LTH E8-100-FR (172452) French



## D 7500E Time Clock

Wireless synchronized with an atomic clock. Automatically calculates worked time, totals and cost per task for up to 100 employees. Automatic print alignment with no overlap. Automatic month, year and daylight saving time change.

LTH 7500E (194886)



## E PC600 Time Clock Badges

Package of 15.

LTH RF-BADGE (248229)

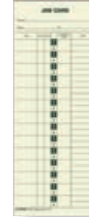
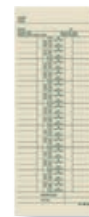

## F E7 Time Cards

For 7000E model. 3-1/4 x 8 in. Box of 1000. English.

LTH E7 (664953)

## G 39-FR Time Cards

For 1600E, 2000, 4000, 5000EP time clocks. Package of 1000. French.

LTH 39-FR (424440)



## H Bilingual Weekly Time Cards

For Acroprint 125, 150, Amano PIX and more. 3-1/2 x 9 po.

TOP 9351-100 (1044916) pkg 100

TOP 9351-250 (1044841) pkg 250

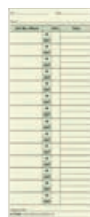

## I 1258 Job Costing Time Cards

For use with Acroprint 125R, 150R, ES700, ES900, ES180, and more. 3-1/2 x 9 in. Box of 1000. English.

TOP 1258 (1044817)

## J 1290 Job Costing Time Cards

Use with Pyramid 1000. 3-1/2 x 8-1/2 in. Box of 500. English.

TOP 1290 (1044825)



## K 3016 Weekly Time Cards

For Pyramid M2500 et 3700. 4-1/4 x 6-3/4 po. Package of 100. English.

TOP 3016 (1044833)

## L Numbered Days Time Cards

One-sided. Printed in green. Numbered days. 3.5 x 9 in. Manila. Pack of 100.

TOP 12563 (1044890) numbered days

TOP 12593 (1044908) named days

## M Overtime Time Cards

For Acroprint 125R, 150R, ES700, ES900, ESP180, and more. 3-3/8 x 8-1/4 in.

Package of 100. English.

TOP 12603 (1044866)





# Serenity

Workers want to well-designed and comfortable spaces. In this section you will find all the furniture components and accessories to create the ideal workspace at the office, and at home.

# WORKPLACE FURNITURE

## WORKSTATIONS

Sit-to-Stand Workstations .....	160
Complete Workstations .....	162
Workstation Components .....	168
Conference/Training Tables .....	169
Mobile Stands and Workstations .....	172
Mobile Filing and Pedestals .....	173
Bookcases .....	175
Plans Filing .....	176

## OFFICE AND CONFERENCE ROOM SEATING

Manager/Conference Room Chairs .....	178
Operator Chairs .....	181
Task Chairs .....	186
Guest Chairs .....	189
Stools .....	192
Chair Mats/Pads .....	193
Chair Casters .....	193

## RECEPTION AND LOUNGE AREA FURNITURE

Reception Desks .....	197
Lounge Seating .....	198
Lounge Tables .....	200
Cloakroom .....	201

## CAFETERIA / LUNCHROOM FURNITURE

Cafeteria Tables .....	202
Table Dollies .....	202
Folding and Stacking Chairs .....	203
Chair Dollies .....	205

## FILING AND STORAGE

Lateral Filing Cabinets .....	206
Vertical Filing Cabinets .....	209
Storage Cabinets .....	212
Lockers .....	213
Shelves .....	214
Fireproof Filing Cabinets .....	215
Security Boxes .....	216
Safes .....	217



## work your way



## inspire productive work and well-being

Adaptable workspace solutions evoke a sense of community and structure, providing personal boundaries while optimizing floor space.

With its clean lines, Ionic™ combines form with function to support a wide range of workplace applications. From private offices to collaborative spaces, boardrooms or reception areas, Ionic offers solutions that will exceed your expectations and keep you on budget. Refined details and commercial quality ensure that Ionic is your long-term solution.



## A Ionic™ Height Adjustable U-Shaped Suite

Ionic U-shaped suite. L-shaped height adjustable table has an easy to operate digital readout key pad with four programmable memory positions, and moves 28.1" to 46.7" high. Hanging pedestal features one box with pencil tray, and one locking file drawer which accommodates front-to-back letter size, or side-to-side legal size files. Overall footprint is 72"W x 96"D x 65"H.

**GLB MLP317ACJ** (829748) absolute acajou  
**GLB MLP317NGL** (829749) noce grigio

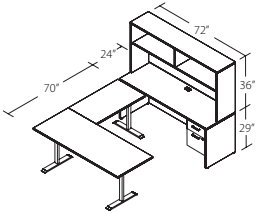

OfficesToGo

## B Ionic™ Height Adjustable L-Shaped Workstation

Ionic quick assembly electric height adjustable L-shaped workstation. Enables users to move freely between sitting and standing positions without interrupting their work space. Preassembled beam and legs that unfold and lock into place for quick assembly. Featuring a dual motor system with built in anti-collision sensor, an easy to operate digital readout key pad and four programmable memory positions. Weight capacity of 265 lbs. Height range from 28.1" to 46.7". Return surface 35"W x 23"D.

**66 x 66 in. Primary worksurface 64"W x 29"D**

**GLB 829746** (829746) absolute acajou

**GLB 829745** (829745) noce grigio

**66 x 63 in. Primary worksurface 64"W x 23"D**

**GLB 829744** (829744) absolute acajou

**GLB829747** (829747) noce grigio

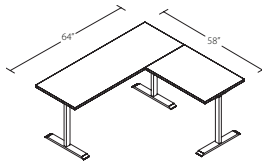
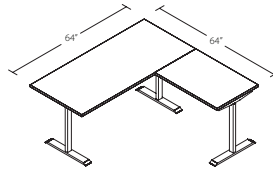

OfficesToGo

## C Ionic™ Adjustable Table Desk

Rectangular table with 2 legs. Electric height-adjustable bases with quick assembly. Pre-assembled leg columns. 2-stage base. Anti-collision sensor. 8" power cord. Laminate tops. Manufacturer five-year warranty. Meets applicable ANSI/BIFMA.

**48 x 24 in.**

**GLB829740** (829740) absolute acajou

**GLB 829741** (829741) noce grigio

**60 x 30 in.**

**GLB 829742** (829742) absolute acajou

**GLB 829743** (829743) noce grigio

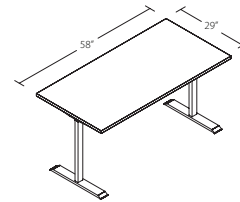
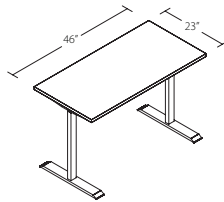

OfficesToGo

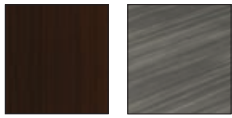

**A Calypso Height adjustable L Workstation**

Commercial grade 1 in. melamine - resists stains and scratches. Height adjustable table with 4-section closed hutch and tackboard. Plexiglass hanging modesty panel. Hanging box / file pedestal with lock and pencil tray. Desk height adjustment from 24.4 to 50 in high.

**HTW 829792** (829792) evening zen

**HTW 829793** (829793) grey dusk

**HTW 829794** (829794) winter wood



\*Stool and accessories are not included.



**B Calypso Height Adjustable Desk**

Commercial grade 1 in. melamine - resists stains and scratches. Height adjustable desk with open cabinet and lateral file with both drawers lock. Notched top for hidden foot design. Desk top is 30 in deep and includes a centre grommet. Desk height adjustment from 24.4 to 50 in high. 71 x 65 in.

**HTW 829798** (829798) grey dusk

**HTW 829800** (829800) grey and white

**HTW 829799** (829799) winter wood



**C Athena L shape height adjustable desk**

With plexiglass hanging modesty panel. Metal mobile metal box / file pedestal with cushion. All drawers lock and locking casters. Pneumatic LCD single monitor arm. Desk height adjustment from 28-1/2 to 45-1/2 in. high. 71 x 71 in.

**HTW 829795** (829795) evening zen

**HTW 829796** (829796) grey dusk

**HTW 829797** (829797) winter wood



**D Sit-to-Stand Height Adjustable Desk**

Includes top and all hardware to assemble yourself and tops are predrilled with machined screws for secure connection. Includes 4 position memory/ USB charging port, built in pencil tray drawer and two grommets for wire management. Table top: 24 x 48 x 3/4 in. Height range: 28.8 - 48 in. 176 lb. White. **HTW 829813** (829813)



## A L-Shaped Standing Desk with Credenza

1-inch thick desktop with durable melamine finish resists scratches, stains, and wear and supports up to 100 lb of materials. Electric standing desk lifts from a low of 28 in to a high of 45 in; a digital display switch allows you to save the top's position and 4 programmable height options are available. Offers 2 open storage compartments to accommodate office supplies. features 1 lockable file drawer, which accepts legal, letter, and A4-size paperwork and 1 paper shelf. 10-year limited warranty. 80.3 x 71.1 x 48.7 in. 326 lb.

**BEX 829589** (829589) grey and white

**BEX 829588** (829588) white

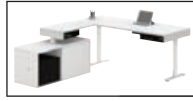

## B Adjustable Computer Table

The electric mechanism allows the height to adjust from 28 to 45 in (must be plugged into an electric outlet). Black metal legs. 1 in. thick commercial-grade melamine finish resists scratches, stains and wear.

**48 x 24 in. desk surface**

**BEX 65857-47** (434225) bark grey

**BEX 65857-52** (350702) antigua

**60 x 30 in. desk surface**

**BEX 65867-47** (434233) bark grey

**BEX 65867-52** (350751) antigua



## C AFS-TEX 2000 Anti-Fatigue Mat

Solid, one-piece 0.7 in. polyurethane construction. Reduces pressure on the body by up to 40%. Ergonomically designed print guide to encourage progressive movement while standing. Anti-slip base. Contoured curl proof edging ensures the mats will remain totally flat. Built-in anti-microbial active ingredient will not wear away or wash off. 10-year limited warranty. 20 x 32 in.

**FLR FCA22032BK** (428433)

## D AFS-TEX 5000 Anti-Fatigue Mat

Solid, ergonomically designed polyurethane construction with contoured non-linear profile of between 0.8 to 2.0 in. Allows individual foot rocking movement to further stimulate blood flow. Use as a foot operated push/pull facility for moving the mat into place when changing from sitting to standing. Embossed top surface. Anti-slip base. Built-in active anti-microbial ingredient will not wear away or wash off. 10-year limited warranty. 26 x 36 in.

**FLR FC5XBK2535** (428441)



## E ActiveFusion™ Anti-Fatigue Mat

Unique shape promotes stretching and movement throughout the day. 36 x 24 in. Black.

**FEL 8707102** (544072)

## F Anti-Fatigue Wellness Mat

Encourages subtle movement to prevent fatigue. 36 x 24 in. Black.

**FEL 8707002** (574566)

## G Polyurethane Anti-Fatigue Mat

Ergonomically engineered. Stimulates blood circulation. Provides strong sole support. Reduces fatigue and pain on legs and feet caused by prolonged standing. Rubberized gel foam. Water-resistant material. 24 x 36 x 0.75 in. Black.

**IKW AF100** (829427)





**A Ionic™ Supervisor Office Suite**

1" thick thermofused melamine surfaces resist scratches and stains. Features 72" rectangular worksurface, a 72" credenza with box/box/file pedestal and an open hutch. 72 x 72 x 65"H.  
**GLB MLP206ACJ** (829770) absolute acajou  
**GLB MLP206NGL** (829771) noce grigio



**A** **OfficestoGo**



**B Ridgeley U-Shaped Workstation**

Add a touch of contemporary and style to your work area. Features durable 1" commercial grade work surfaces with melamine finish that resist scratches, stains and wear. The pedestal features one utility drawer and two file drawer with letter/legal filing system. The hutch has two doors and two adjustable shelves that allow closed and open storage. Fully reversible unit. 93.6 x 65.9 x 65"H.  
**BEX 52414-31** (434142) chocolate white/black  
**BEX 52414-79** (434159) chocolate/black



**B** **BESTAR**



## INNOVATIONS DESK SUITE

Heartwood's Innovations series is commercial grade 1 in. melamine resists stains and scratches. Pedestals are locking and ship fully assembled. Backed by a limited lifetime warranty. Many components are Made in Canada. Flexibility needed in the modern workplace to accommodate individual needs. High quality construction with 1in. thick commercial grade tops, durable 3 mm thick PVC edging. Choose from one these 4 configurations. Assembly required.



### A L-Shape Workstation with Open Hutch

This workstation includes 65 in. desk with corner extension and return shell, box/file hanging pedestal, 65 in. open hutch with tack surface.

**HTW 829780** (829780) evening zen

**HTW 829781** (829781) evening zen

**HTW 829782** (829782) winter wood



### B L-Shape Workstation with Closed Hutch

This workstation includes 65 in. desk with corner extension and return shell, box/file hanging pedestal, 65 in. closed hutch with tack surface and frosted glass doors.

**HTW 829786** (829786) evening zen

**HTW 829787** (829787) grey dusk

**HTW 829788** (829788) winter wood



### C L-Shape Workstation with Right Bridge Return

This workstation includes 71 in. desk with corner extension and return shell, box/file hanging pedestal, 71 in. closed hutch with tack surface and solid doors.

**HTW 829789** (829789) evening zen

**HTW 829790** (829790) grey dusk

**HTW 829791** (829791) winter wood



### D L-Shape Workstation with Left Bridge Return

This workstation includes 71 in. desk with corner extension and return shell, box/file hanging pedestal, 71 in. closed hutch with tack surface and solid doors.

**HTW 829783** (829783) evening zen

**HTW 829784** (829784) grey dusk

**HTW 829785** (829785) winter wood



**A Ionic™ L Shape Workstation**

1"-thick thermofused melamine surfaces resist scratches and stains. Features 60" rectangular work surface and bridge with box/box hanging pedestal. 60 x 78 x 29"H.  
**GLB MLP107ACJ** (829764) absolute acajou  
**GLB MLP107NGL** (829765) noce grigio



**OfficestoGo**



**B Ionic™ L-Shaped Workstation**

Monopost rectangular work surface. Credence shell with box/file hanging pedestal. 66 x 66 x 29"H.  
**GLB MLP113ACJ** (829768) absolute acajou  
**GLB MLP113NGL** (829769) grey



**OfficestoGo**



\*Pedestal not included.

**C Titan Metal Workstation**

1"-thick thermally fused melamine top. Steel base and modesty panel are powder coated. 3 mm PVC edge with rounded corners. 71 x 71 x 28.75 in.  
**HTW 376236** (376236) autumn  
**HTW 440263** (440263) grey dusk  
**HTW 376244** (376244) maple



**D Lodi TYP32 L-Shaped Workstation**

Combines, open, contemporary appearance and modern quality details. 66 x 30" laminate desk shell with hanging pedestal and 3/4 modesty panel. Return shell, 42 x 20". Hanging pedestal with utility and file drawers, 15.5 x 18.5". 66 x 72 x 29"H. Urban walnut finish.  
**OSP 439869** (439869)



## A Pro-Linea L-Shaped Workstation

Pro-Linea has all the elements to create a modern and refined work environment. Surface is made of a durable 1.5" commercial grade work surface with melamine finish that resists scratches, stains and wear. Full height modesty panel. The credenza features one utility drawer, one file drawer with letter/legal filing system and three shelves. The workstation is fully reversible. 71-1/8 x 71-1/8 x 29-3/4". Bark grey finish.

**BEX 120863-47** (434258)



## B Pro-Linea L-Shaped Workstation

Pro-Linea has all the elements to create a modern and refined work environment. Surface is made of a durable 1.5" commercial grade work surface with melamine finish that resists scratches, stains and wear. The credenza features one utility drawer, one file drawer with letter/legal filing system and three shelves. Square metal legs in matte silver finish. The workstation is fully reversible. 71-1/8 x 71-1/8 x 29-3/4". Bark grey finish.

**BEX 120883-47** (434266)



## C Solay L-Shaped Desk

Perfect fit for any area surrounding you with everything within arm's reach. The work surface features a durable 1" commercial grade work surface with melamine finish that resists scratches, stains and burns. One utility drawer and one file drawer with letter/legal filing system. Fully reversible design. Open storage sections. Metal legs. Fully finished on the back. 59.3 x 59.3 x 29.7 in. H.

**BEX 29420-17** (434043) white

**BEX 29420-47** (434068) bark grey





**A Ionic™ MLP111 Single Pedestal Desk**

60 x 30" work surface combined with a hanging box/file pedestal. Thermally fused laminate surfaces, durable 3mm PVC edge, leveling glides.

**GLB MLP111NGL** (829767) noce grigio

**GLB MLP111ACJ** (829766) absolute acajou

**A** **OfficestoGo**



**B Mira Desk**

Commercial-grade, 1"-thick laminate surface resists scratches and water. Rugged 2 mm edges. Hanging pedestal with utility/filing letter sized drawers.

**HTWMA112448CE** (248633) cayenne cherry

**48 x 24 x 29 in. H.**

**HTWMA112448GD** (440180) grey dusk

**60 x 30 x 29 in. H.**

**HTWMA123060WW** (829779) winter white

**B** **HDI**  
Heartwood Distributors Ltd.



**C Lodi TYP4 Double Pedestal Desk**

Combines, open, contemporary appearance and modern quality details. 30 x 60" laminate work surface with 3/4" modesty panel. Two hanging pedestals with utility and file drawers, 15.5 x 18.5". 60 x 30 x 29"H. Urban walnut finish.

**OSP 439851** (439851)

**C** **OFFICE STAR**  
PRODUCTS



**D Titan Metal Desk**

1" thick thermally fused melamine top. Steel base and modesty panel are powder coated. 3 mm PVC edge with rounded corners. 71 x 29.75 x 28.75 in.

**HTW 376210** (376210) autumn

**HTW 440255** (440255) grey dusk

**HTW 376228** (376228) maple

**D** **HDI**  
Heartwood Distributors Ltd.

\*Pedestal not included





## A Slim Secretary Desk

Stylish and practical. Raised by two legs reminiscent of wrought iron, this shallow piece of furniture fits into any living room or passageway, such as a hallway. Its exclusive design and its numerous storage spaces make it a functional and discreet space-saver. Engraved flap door in a textured lacquer finish with a geometric pattern serves as a work surface when open. Hinged door. 3 adjustable shelves. Easy and quick to assemble, this workstation needs to be fixed to the wall. MDF, melamine and laminate finish is scratch, stain and water resistant. 1-year limited warranty. 35.7 x 8.25 x 54 in.

**MFI 611031** (829564) walnut  
**MFI 611057** (829565) nutmeg/grey



Perfect for your home office



## B Arabas Single Drawer Desk

Drawer mounted on full extension slides. Open back panel for easy wire management. Desk back panel is finished for maximum flexibility in your home office area. 22 x 47.75 x 30.75 in.

**MFI601803** (829559) white  
**MFI 601844** (829560) dark grey  
**MFI 601862** (829561) nutmeg

## C Tangent Desk with Storage

Scandinavian inspired geometric lines. The mix of light tones combines Nordic style with birch plywood legs and the contemporary look is enhanced by the unique colour of the rectangular worktop. Wood. 60 x 120 x 75 in.

**MFI609072** (829562) white  
**MFI 609075** (829563) grey

**A nexera**

Must be fixed to a wall

## D Pashley Table

Rectangular table with 4 tapered angled legs. 1 in. thick thermally fused laminate work surfaces. Meets applicable ANSI/BIFMA x5.5 standards. Laminate tops. Levelling glides included. 29 in. high.

**48 x 24 in.**  
**GLB 829750** (829750) absolute mahogany  
**GLB 829751** (829751) noce grigio  
**60 x 30 in.**  
**GLB 829752** (829752) absolute acajou  
**GLB 829753** (829753) noce grigio

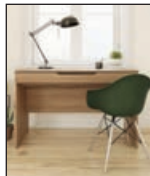
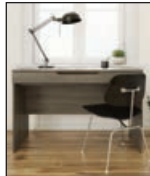

## E Ionic Bar Height Maker Table

Rectangular table. 1" thick thermally fused laminate top with painted steel H-legs and footbar. Includes adjustable leveling glides.

**48 x 30 x 32 in.**  
**GLB 829754** (829754) absolute acajou  
**GLB 829755** (829755) noce grigio  
**48 x 30 x 42 in.**  
**GLB 829756** (829756) absolute acajou  
**GLB 829757** (829757) noce grigio

**B nexera**



**C nexera**



**D OfficestoGo**



**E OfficestoGo**



DESCRIPTION	DIMENSION L X D X H	WEIGHT (LB)	MAHOGANY	CHERRY	PRICE
<b>A. RECTANGULAR DESK</b>	48 x 24 x 29-1/2 in.	88	LLR 69375 (1056043)	LLR 69411 (1056035)	
	48 x 30 x 29-1/2 in.	101	LLR 69902 (1056142)	LLR 69903 (1056928)	
	60 x 30 x 29-1/2 in.	115	LLR 69373 (1056068)	LLR 69409 (1056051)	
	66 x 30 x 29-1/2 in.	124	LLR 69372 (1056084)	LLR 69408 (1056076)	
	72 x 30 x 29-1/2 in.	133	LLR 69535 (1056126)	LLR 69534 (1056118)	
	72 x 36 x 29-1/2 in.	148	LLR 69371 (1056100)	LLR 69407 (1056092)	
<b>B. CREDENZA</b>	72 x 24 x 29-1/2 in.	110	LLR 69376 (1055830)	LLR 69412 (1055822)	
<b>C. HUTCH WITH DOORS</b>	66 x 15 x 36 in.	138	LLR 69383 (1056365)	LLR 69417 (1056358)	
	72 x 15 x 36 in.	142	LLR 69382 (1056373)	LLR 69416 (1056381)	
<b>D. TACKBOARD (BLACK)</b>	64-1/2 x 3/4 x 16-1/2 in.	18	LLR 69915 (1056829)		
<b>E. RETURN</b>	36 x 24 x 29-1/2 in.	66	LLR 69389 (1056738)	LLR 69423 (1056746)	
	42 x 24 x 29-1/2 in.	73	LLR 69388 (1056720)	LLR 69422 (1056712)	
	48 x 24 x 29-1/2 in.	82	LLR 69387 (1056761)	LLR 69421 (1056754)	
<b>F. BRIDGE</b>	42 x 24 x 29-1/2 in.	57	LLR 69391 (1055665)	LLR 69426 (1055658)	
	48 x 24 x 29-1/2 in.	66	LLR 69390 (1055681)	LLR 69424 (1055673)	
<b>G. BOX/BOX/FILE MOBILE PEDESTAL</b>	16 x 22 x 16-1/4 in.	80	LLR 69395 (1057645)	LLR 69430 (1057637)	
<b>H. FILE/FILE MOBILE PEDESTAL</b>	16 x 22 x 28-1/4 in.	71	LLR 69397 (1057702)	LLR 69431 (1057694)	
<b>I. BOX/BOX/FILE FIXED PEDESTAL</b>	16 x 22 x 28-1/4 in.	71	LLR 69603 (1057629)	LLR 69604 (1057686)	
<b>J. FILE/FILE FIXED PEDESTAL</b>	16 x 22 x 28-1/4 in.	71	LLR 69605 (1057728)	LLR 69606 (1057710)	
<b>K. BOX/FILE FIXED PEDESTAL</b>	16 x 22 x 21 in.	60	LLR 69398 (1057660)	LLR 69432 (1057653)	
<b>L. 2 DRAWER LATERAL FILING CABINET</b>	35-1/2 x 22 x 29-1/2 in.	150	LLR 69399 (1057587)	LLR 69433 (1057579)	
<b>M. OVAL CONFERENCE TABLE</b>	72 x 36 x 29-1/2 in.	110	LLR 87272 (1058189)	LLR 87373 (1058171)	
<b>N. UNIVERSAL KEYBOARD TRAY</b>	26 x 15-5/8 x 3/4 in.	11	LLR 87523 (1056894)	LLR 87526 (1056886)	



## Tucana Training Tables

Tucana Training Tables provide a versatile work surface solution for virtually any group or gathering. Adaptable, expandable, and easily stores away when not in use.

### Sturdy commercial grade construction featuring:

- Heavy-duty welded metal bases with attractive powder coat finish.
- Easy mobility with locking heavy-duty casters.
- Perforated metal modesty panel with built-in cable tray for easy cable management.
- 1-inch thick thermally fused laminate tops with radius corners.
- Tops are edged with contrasting T-moulded for durability.
- Tops and Bases are ordered separately.

### A 72 in. Rectangular Table Top

72 x 24 in.

- HTW 144139 (144139) mahogany
- HTW 144147 (144147) henna cherry
- HTW 440248 (440248) grey
- HTW829772 (829772) winter wood

### B 60 in. Rectangular Table Top

60 x 24 in.

- HTW 144071 (144071) mahogany
- HTW 144105 (144105) henna cherry
- HTW 440230 (440230) grey
- HTW829773 (829773) winter wood

### C 36 in. Rectangular Table Top

36 x 24 in.

- HTW 144055 (144055) mahogany
- HTW 144063 (144063) henna cherry
- HTW 440222 (440222) grey
- HTW829774 (829774) winter wood



### D Trapezoid Table Top

48 x 24 in.

- HTW 144154 (144154) mahogany
- HTW 144162 (144162) henna cherry
- HTW440206 (440206) grey
- HTW829775 (829775) winter wood

### E Half-Round Table Top

48 x 24 in.

- HTW 143982 (143982) mahogany
- HTW143990 (143990) henna cherry
- HTW 440198 (440198) grey
- HTW829776 (829776) winter wood

### F Quarter-Round Table Top

30 x 30 in.

- HTW 144030 (144030) mahogany
- HTW 144048 (144048) henna cherry
- HTW440214 (440214) grey
- HTW829777 (829777) winter wood

### G Stainless Steel Table Base

Depth: 20 in. Height: 28.8 in.

For 60 and/or 72 in. tops. Length: 58 in.  
HTW 144022 (144022)

For 30 in. tops. Length: 15 in.  
HTW 144006 (144006)

For 36 and/or 48 in. tops. Length: 24 in.  
HTW 144014 (144014)

For 60 in. tops. Length: 40 in.  
HTW TU97L5420 (829778)

### H Joining Plate

For Quarter round top. Can be used instead of TU 97L-1520 base when Quarter Round Top is supported between two adjoining tables that have bases.

HTW 144170 (144170)





**A Innovations Round Table Top**

Durable, premium thermally fused woodgrain laminate top on a 1" thick 45lb particle board core. Base sold separately. **36 in dia.**

- HTW INVR36EZ** (1017771) evening Zen
  - HTWINVR36GD** (1017797) grey dusk
  - HTW INVR36SM** (1017805) sugar maple
  - HTWINVR36WW** (829804) winter wood
  - HTW INVR36HPWH** (1022789) white
- 42 in dia.**
- HTW INVR42EZ** (1017763) evening Zen
  - HTW INVR42GD** (1017789) grey dusk
  - HTW INVR42SM** (1017888) sugar maple
  - HTWINVR42WW** (806265) winter wood



**B Innovations Square Table Top**

36 x 36 in. 1 in. thick thermally fused commercial grade laminate top with durable long lasting 3mm PVC edge. Compatible with HDL metal legs and bases. No drilling. Covered by HDL limited lifetime warranty.

- HTW INVSQ36EZ** (1022797) evening zen
- HTW INVSQ36GD** (1022805) grey dusk
- HTW INVSQ36SM** (1022813) sugar maple
- HTWINVR42WW** (829806) winter wood

**C Cross Table Base**

Metal. Powder finish. Includes levelers for quick and easy positioning on uneven surfaces. Table top is sold separately. 28 in. H. Black. **HTW 900CROSS30** (1022706)

**D Square Table Base**

Metal base with a square post support. Powder coat finish. Includes levelers for quick and easy positioning on uneven surfaces. 19-3/4 x 19-3/4 in. Top sold separately.

- Height: 28 in.**
- HTW 900SQB20BL** (1022896) black
  - HTW 900SQB20SL** (1022904) silver
  - HTW900SQB20WH** (1071852) white
- Height: 41 in.**
- HTW 900SQB20BB** (1022862) black
  - HTW 900SQB20BS** (1022870) silver
  - HTW 900SQB20BW** (1022888) white

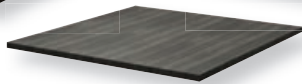

**E Ionic Boat Shaped Conference Table**

One piece top (1 1/8 in. thick top). Thermally fused laminate. Top tapers to 40 in. deep at the ends. 2mm PVC matching edge. Designed for quick and easy assembly. Tested to meet ANSI & BIFMA desking standards.

- 96 x 48 in. Mahogany.**
- GLB ML96BTACJ** (829763)



## Innovation Series Conference Tables

Create a meeting space that complements your style. The 1" thick top is finished with durable, premium, thermally fused, woodgrain laminate. Water-resistant, scratch-resistant, dent-resistant and burn-resistant. Tough, 3mm thick, PVC colour-matched edging. Laminate base with modesty panel is sold separately.

### A Expandable Racetrack Table

The 1 in. thick top is finished with durable, premium, thermally fused, woodgrain laminate. Water-resistant, scratch-resistant, dent-resistant and burn-resistant. Tough, 3mm thick, PVC colour-matched edging. 94-1/2 x 47-1/4". Height: 28". Laminate base with modesty panel is sold separately.

#### Table top

**HTW INV RTE96EZ** (1018019) evening Zen

**HTW INV RTE96GD** (1018027) grey dusk

**HTW829807** (829807) winter wood

#### Base (71 x 23-3/4 in.)

**HTW INV PSE96EZ** (1017954) evening Zen

**HTW INV PSE96GD** (1017961) grey dusk

**HTW INV PSE96WW** (829808) winter wood



GREY DUSK



EVENING ZEN



WINTER WOOD

### B Extension Kit for Expandable Racetrack Table

The 1 in. thick top is finished with durable, premium, thermally fused, woodgrain laminate. Water-resistant, scratch-resistant, dent-resistant and burn-resistant. Tough, 3mm thick, PVC colour-matched edging. Table top and base sold separately.

#### Square table top - 47-1/2 in.

**HTW INV SQ48EZ** (1022839) evening Zen

**HTW INV SQ48GD** (1022847) grey dusk

**HTW INV SQ48WW** (829811) winter wood

#### 28 in. high base

**HTW INV PSE48EZ** (1017995) evening Zen

**HTW INV PSE48GD** (1017987) grey dusk

**HTW INV PSE48WW** (829812) winter wood

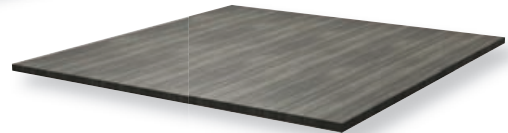

GREY DUSK



EVENING ZEN



WINTER WOOD

### C Expandable Racetrack Table

The 1 in. thick top is finished with durable, premium, thermally fused, woodgrain laminate. Water-resistant, scratch-resistant, dent-resistant and burn-resistant. Tough, 3mm thick, PVC colour-matched edging. Laminate base with modesty panel is sold separately.

#### Table top - 94-1/2 x 47-1/4 in.

**HTW INV RT72EZ** (1071125) evening Zen

**HTW INV RT72GD** (1071133) grey dusk

**HTW INV RT72SM** (1071141) sugar maple

**HTW829809** (829809) winter wood

#### Base (39-1/2 x 23-3/4 x 28 in. H)

**HTW INV PS72EZ** (1071091) evening Zen

**HTW INV PS72GD** (1071109) grey dusk

**HTW INV PS72SM** (1071117) sugar maple

**HTW INV PS72WW** (829810) winter wood



GREY DUSK



EVENING ZEN

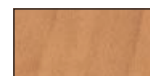

SUGAR MAPLE



WINTER WOOD



**A**  **SAFCO**



**B**  **SAFCO**



**A Scoot™ Underdesk Printer/Fax Stand**

14-1/2" high, hides printers and small office machines under most workspaces. Attractive black stand with unique hole pattern design and silver leg accent. Black powder coated steel and black laminate top. 4 casters, 2 locking. 20-1/4 x 16-1/2 x 14-1/2"H. **SAF 1855BL** (787903)

**B Scoot™ Deskside Printer/Fax Stand**

One height-adjustable shelf and adjustable hot file on the side. Attractive black stand with unique hole pattern design and silver leg accent. Black powder coated steel and black laminate top. 4 casters, 2 locking. 26-1/4 x 20-1/4 x 26-1/4"H. **SAF 1856BL** (787911)

**C Underdesk Printer/fax Stand**

Steel frame with laminate top provides ample space for most printers or fax machines. 13-1/2" high for convenient placement under the desk. Supply shelf. 4 swivel casters, 2 locking. Easy assembly, no tools required. 19 x 16 x 13-1/2"H. Black. **SAF 5206BL** (787986)

**D Deskside Printer and Fax Stand**

Durable plastic construction. Includes a platform and 2 shelves. 4 dual-wheel carpet casters, 2 locking. Each shelf supports up to 50 lbs. 20 x 17.5 x 29 in. H. Grey. Greenguard certified. Limited lifetime warranty. **SAF 1860GR** (1055467)



**C**  **SAFCO**



**D**  **SAFCO**



**E Underdesk Printer and Fax Stand**

Durable plastic construction. 1 shelf. 4 dual-wheel carpet casters, 2 locking. 20 x 17.5 x 11.5 in. H. Grey. Greenguard certified. Limited lifetime warranty. **SAF 1861GR** (1055475)

**F Ionic Adjustable Personal Table**

Rectangular table with adjustable height. Dynamic load capacity of 8 kg. BIFMA compliance. With wheels. 28 x 19 x 28-3/4 to 44 in. Absolute mahogany finish. **GLB 829758** (829758)



**E**  **SAFCO**



**F** 



## A 2-Drawer Mobile File

For legal-size filing, 19-5/8 x 17-9/16 x 26-11/16"H.  
**MFI 5093** (648071) natural maple  
**MFI 12093** (138206) truffle  
**MFI 6093** (166819) black  
**MFI 8093** (138180) cappuccino



## B 3-Drawer Mobile Pedestal

2 utility drawers and 1 file drawer. On casters. Legal sized drawers.  
 19-5/8 x 17-5/8 x 26-5/8 in. H. Maple.  
**MFI 5092** (708743)

## C 2-Drawer Mobile File Cabinet

Sturdy plastic. 2 drawers 18 in. Deep. Hanging rails are suitable for letter-size hanging folders and include a device for legal files. Casters and label holders included. 12.75 x 18.25 x 26 in (without casters), 15 in casters.  
**STX 61301B01C** (697938) beige  
**STX 61309B01C** (188698) black



## D Metal Mobile File Cabinet

Metal Mobile box/file pedestal, 23" deep. Recessed angled full pulls. Four hooded casters included. Ball bearing drawer suspension. Includes pencil tray and one set of side-to-side file bars. Counterweight included. Lock mounted on right-hand side. Dimensions: 15 x 22.5 x 23.13 in.  
**GLB 809087** (809087) white  
**GLB MVL23BFLK** (809095) black



## E 2-Drawer Smart File

High-side drawers with smooth glide suspension. Welded steel construction. Baked enamel finish. Meets or exceeds ANSI/BIFMA standards. Greenguard Gold Certified. 14-1/4 x 18 x 24-1/2 in. H. 1-year warranty. Black.  
**LLR 14341** (1020387)

## F 2-Drawer Mobile File

Letter size. High-side drawers with smooth glide suspension. Welded steel construction. Baked enamel finish. Meets or exceeds ANSI/BIFMA standards. Greenguard Gold Certified. 1-year warranty.  
**LLR 19156** (1020395) white  
**LLR 16872** (1020361) black



## G Slim Mobile Pedestal

Features 1 storage drawer and 1 letter or legal filing drawer. Ball-bearing suspension. Locking drawer. Recessed handle. Made steel. Recycled content. Assembly Required. 10 x 20 x 21-3/4 in. H. Greenguard Certified. Covered by Lorell limited lifetime warranty.  
**LLR 66954** (1020958) black  
**LLR00047** (1021039) silver  
**Concealed drawers**  
**LLR 66958** (1071380) black





**A 3-Drawer Mobile Pedestal**

Metal. Two utility and one file drawers. On casters. 15.5 x 22.5 x 25.2"H.  
**HTW 100MMPUFWH** (440172) white  
**HTW100MMPUFBL** (376251) black  
**HTW 100MMPUFTT** (376269) titanium

**B 3-Drawer Mobile**

Perfect-sized filling solutions for small office and home office. High-side drawers with smooth glide suspension. Welded steel construction. Baked enamel finish. 2 filling drawers and 1 pencil organizer drawer. 14-1/4 x 18 x 29-1/2 in. H. Meets or exceeds ANSI/BIFMA standards. Greenguard Gold Certified. 1-year warranty.  
**LLR19157** (1020403) white  
**LLR 17427** (1020379) black

**A**



**C 2-Drawer Pedestal File**

Features 2 filing drawers. Ball-bearing suspension. Includes security lock. Recessed handle. Made steel. Letter size. Contains 28% recycled content. Covered by Lorell limited lifetime warranty.

**15 x 20 x 27-3/4 in. H.**  
**LLR00050** (1021013) white  
**LLR 49524** (1020866) black  
**LLR00053** (1021021) silver  
**LLR 49523** (1020882) putty  
**LLR 49525** (1020874) light grey  
**15 x 23 x 27-3/4 in. H.**  
**LLR 49530** (1020924) black  
**LLR 49531** (1020932) light grey  
**LLR 49529** (1020940) putty



**D 3-Drawer Pedestal File**

Features 2 storage drawers and 1 filing drawer. Ball-bearing suspension. Includes security lock. Recessed handle. Made steel. Letter size. Contains 28% recycled content. Covered by Lorell limited lifetime warranty.

**15 x 20 x 27-3/4 in. H.**  
**LLR00049** (1020999) white  
**LLR 49521** (1020833) black  
**LLR00052** (1021005) silver  
**LLR 49522** (1020841) light grey  
**LLR 49520** (1020859) putty  
**15 x 23 x 27-3/4 in. H.**  
**LLR 49528** (1020908) light grey  
**LLR 49527** (1020890) black  
**LLR 49526** (1020916) putty

**B**



**E Hanging Slim Pedestal**

Features 1 storage drawer and 1 letter or legal filing drawer, concealed. Ball-bearing suspension. Locking drawer. Recessed handle. Made of steel. Letter and legal size. 10 x 20 x 19-1/4 in. H. Recycled content. Greenguard Certified. Covered by Lorell limited lifetime warranty.

**LLR 00046** (1020981) silver  
**LLR 00045** (1020973) black



**C**



**D**



**E**





**A Fileworks® Bookcase**

Metal. 36 x 12 in.  
**48 in. height, 3 shelves.**  
 GLB 709667 (709667) black  
 GLB 709683 (709683) grey  
 GLB 709675 (709675) nevada  
**72 in. height, 5 shelves.**  
 GLB 709691 (709691) black  
 GLB 709717 (709717) grey  
 GLB 709709 (709709) nevada



**B Ionic Bookcase**

One fixed shelf and three adjustable shelves. 11/16 in thick shelves.  
 Four levelers. 30 x 12 x 65 in.  
**48 in. high - 3 shelves**  
 GLB ML48BCACJ (829759) mahogany  
 GLB ML48BCNGL (829760) noce grigio  
**60 in. high - 4 shelves**  
 GLB ML65BCACJ (829761) mahogany  
 GLB ML65BCNGL (829762) noce grigio

**C Fortress Series Bookcase**

Bookcase features fully adjustable shelves for flexible storage solutions. Shelves adjust in 1" increments, and each offers a 200 lb capacity. The bottom shelf is fixed. Welded steel construction offers a powder-coat finish for durability. Bookcase meets or exceeds ANSI/BIFMA shelf standards. 34-1/2 in. wide x 13 in. deep.

**2 shelves (1 adjustable) - 30 in. H**  
 LLR 41282 (1021849) black  
 LLR 41280 (1022193) light grey  
 LLR 41281 (1021857) putty  
**3 shelves (2 adjustable) - 42 in. H**  
 LLR 41285 (1021898) black  
 LLR 41283 (1021906) light grey  
 LLR 41284 (1021914) putty  
**4 shelves (3 adjustable) - 60 in. H**  
 LLR 41288 (1021956) black  
 LLR 41286 (1021963) light grey  
 LLR 41287 (1021971) putty  
**5 shelves (4 adjustable) - 72 in. H**  
 LLR 41291 (1022011) black  
 LLR 41289 (1022029) light grey  
 LLR 41290 (1022037) putty  
**6 shelves (4 adjustable) - 82 in. H**  
 LLR 41294 (1022060) black  
 LLR 41292 (1022078) light grey  
 LLR41293 (1022086) putty





**A**  **SAFCO**



**B**  **SAFCO**

**A Plan Mobile File**

Lightweight tubular steel frame with chrome plated grids. Square tube design. On casters. 18-1/2 x 14-1/4 x 23-1/2"H. Grey.  
**12 compartments, 3-3/4 x 3-3/4"**  
**SAF 3090** (776690)  
**20 compartments, 2-3/4 x 2-3/4"**  
**SAF 3091** (776682)

**B Mobile Stand for Plans**

Steel construction. Self-contained storage system with four 3" ball bearing swivel casters. 2 locking casters. Hanging clamps swivel from side-to-side. For 12 hanging clamps, sold separately. Tropical sand powder coat finish. 27 x 27-1/2 to 37-1/2 x 43-5/8 to 61-5/8"H.  
**SAF 5026** (771055)

**C Wall Rack for Plans**

Create a space-saving vertical filing system. Hanging clamps swing freely from side-to-side to reveal content. Holds 12 clamps, sold separately. Tropical sand powder coat finish. 24 x 9-3/4".  
**SAF 5016** (771048)

**D Hanging Clamp**

Bright, extruded, aluminum clamps with black nylon wing knobs provide balanced gripping tension and a smart look for presentation. Clear plastic label holders. Each Hanger Clamp can hold 100 sheets or 20 lbs. Greenguard certified.

- For 18 x 24" sheets - package of 6**  
**SAF 5001-6** (511857)
- For 24 x 36" sheets - by each**  
**SAF 5002-6** (771014)
- For 30 x 42" sheets - by each**  
**SAF 5003-6** (771022)
- For 36 x 48" sheets - by each**  
**SAF 5004-6** (771030)
- For 42 x 60" sheets - package of 6**  
**SAF 5005-6** (511865)



**C**  **SAFCO**

**STOCK**  
24-72h

**D**  **SAFCO**



**E Roll/Stor® Vertical Plan Stand**

Corrugated paper. 20 compartments with reinforced double wall partitions. Hand hole. 15-1/4 x 12-1/4 x 21-7/8"H. Woodgrain finish. 60% recycled content.  
**FEL 20220** (183335)

**F Compartment Roll File**

16 compartments rolled document storage. Constructed from corrugated fiberboard. Steel-reinforced frame has a label grid for easy identification of documents. Secure the contents with a hook-and-look closure on the flaps. Limited lifetime warranty. Assembly Required. White. 12-3/4 x 37 x 12-1/2 in. H.  
**SAF 3098** (1055145)



**E**  **BANKERS BOX**



**F**  **SAFCO**





We offer a  
large selection  
of chairs  
for work...

How you  
use them is  
up to you.



**A**

**OfficestoGo**



**B**

**OfficestoGo**



**A Brighton MVL2787 High Back Management Tilter Chair**

Upholstered in leather. Tilter mechanism. Features include lumbar height adjustment, waterfall seat edge, contoured cushions. Adjustable seat height. Limited lifetime warranty. Dimensions: 25-1/2 x 28 x 44" H. Black. Made in Canada. Certified by Greenguard.  
**GLB 315580** (315580)

**B Kazan OTG11670B High Back Management Tilter Chair**

Upholstered in leather with multi-segmented cushions. Tilter mechanism. Features include tension adjustment, chair tilt lock, waterfall seat edge, contoured cushions. Adjustable seat height. Limited lifetime warranty. Dimensions: 25-1/2 x 29-1/2 x 46" H. Black. Certified by Greenguard.  
**GLB OTG11670B** (789693)

**C Ashmont MVL2780 High Back Management Tilter Chair**

Upholstered in leather with contrast stitching. Tilter mechanism. Features include tension adjustment, chair tilt lock, waterfall seat edge, contoured cushions. Adjustable seat height. Adjustable arm height. Limited lifetime warranty. Dimensions: 27 x 28 x 42" H. Black. Made in Canada. Certified by Greenguard.  
**GLB 315572** (315572)



**C**

**OfficestoGo**



**D**

**OfficestoGo**



**D Pacific MVL11870 High Back Management Tilter Chair**

Upholstered in leather with plush cushions. Tilter mechanism. Features include tension adjustment, chair tilt lock, waterfall seat edge, contoured cushions. Adjustable seat height. Limited lifetime warranty. Dimensions: 25-1/2 x 28-1/2 x 44-1/2" H. Black. Made in Canada. Certified by Greenguard.  
**GLB 253906** (253906)

**E High-Back Executive Armchair**

Seat and back covered with bonded leather. Soft padded armrests. Adjustable height seat. Adjustable tilt tension. Black. 29 x 28.5 x 46 in. H. Covered by Lorell limited 5-year warranty.  
**LLR 83308** (1053560)

**F High-Back Executive Armchair**

Seat and back covered with bonded leather. Soft padded armrests. Adjustable height seat. Adjustable tilt tension. Black. 27 x 32 x 44-1/2" H. Covered by Lorell limited 5-year warranty.  
**LLR 59535** (1054642)



**E**

**LORELL**



**F**

**LORELL**



## A Carleton™ High Back Tilter Chair

S-curve back shape for support of lumbar, shoulders and head. Tilter mechanism. Features include tension adjustment, chair tilt lock, waterfall seat edge, contoured cushions. Adjustable seat height. Height adjustable arms. Limited lifetime warranty. Greenguard certified. Graphite.  
**GLB 0TG11358** (829728)



## B Work Smart™ EC Executive Armchair

High back. Thick padded contour seat and back with built-in lumbar support. Pneumatic seat height adjustment. Locking tilt control with adjustable tilt tension. Padded nylon loop arm. Dual wheel carpet casters. Upholstered eco-leather. Black.  
**OSP EC6583-EC3** (308569)



## C Activ A-601 High Back Armchair

Executive armchair. Simple tilt mechanism with tension adjustment. Pneumatic height adjustment. Padded, fixed loop arms. Soft faux leather upholstery. Black.  
**HZN A-601-BLK** (429191)

## D Annapolis MVL2733 High Back Tilter Chair

Upholstered in fabric. Tilter mechanism. Features include tension adjustment, chair tilt lock, waterfall seat edge, contoured cushions. Adjustable seat height. Limited lifetime warranty. Dimensions: 25-1/2 x 28 x 43" H. Black. Made in Canada. Certified by Greenguard.  
**GLB 198077** (198077)



## E Annapolis MVL2732 High Back Tilter Chair

Upholstered in leather. Tilter mechanism. Features include tension adjustment, chair tilt lock, waterfall seat edge, contoured cushions. Adjustable seat height. Limited lifetime warranty. Dimensions: 25-1/2 x 28 x 43" H. Black. Made in Canada. Certified by Greenguard.  
**GLB 198069** (198069)



## F Mid-Back Executive Armchair

Seat and back covered with bonded leather. Adjustable height seat. Adjustable tilt tension. Black. 26-1/4 x 27-1/2 x 42"H. Covered by Lorell limited 5-year warranty.  
**LLR 84869** (1053545)

## G Activ™ A-128 Executive Armchair

High back with simulated leather fabric. Simple tilt seat and back movement. Pneumatic seat height adjustment. Tilt-tension adjustment and vertical tilt-lock control. Fixed loop style polyurethane armrests. Black.  
**HZN A-128** (350538)





**A**  **OFFICE STAR® PRODUCTS**



**B** **OfficestoGo**



**A Work Smart™ FL Executive Armchair**  
 Faux leather seat and back with built-in lumbar support. Locking tilt control with adjustable tilt tension. Fixed padded loop arms. Heavy-duty nylon base with dual wheel carpet casters. Black. **OSP FL660-U6** (308544)

**B Overtime 350™ High Back Multi-Tilter Chair**  
 For users of above average height and/or weight, up to 350 lbs. Multi-tilt mechanism. Long-term comfort seat, memory foam top. Height and width adjustable arms with sliding, rotating and lockable armcaps. Features include tension adjustment, chair tilt lock, lumbar height adjustment, waterfall seat edge, contoured cushions. Adjustable seat angle and height. Sliding seat depth adjustment. Dual wheel carpet casters. Covered in Luxhide bonded leather. Made in Canada. Certified by Greenguard. Black. **GLB 829738** (829738)

**C High-Back Obusforme® Comfort XL Armchair**  
 For users between 225-400 lb. High back (extra tall), wider and deeper seat with weight sensing synchronized tilter that automatically adjusts the reclining tilt-tension for each user's individual weight. Ratchet style back/lumbar height adjustment with 5-1/4" of vertical travel. Side activated sliding seat depth adjustment. Multiple position tilt-lock control. Height and width adjustable "T" arms with urethane adjustable arms. Fabric upholstery. Carbon. **GLB 12550TC74** (506097)



**C** 



**D** 



**D Fenwick™ Heavy-Duty Armchair**  
 Mid back multi-tilter. Designed for seating and supporting diverse workers around the clock. Comfortably supports workers up to 400 lb with a wide-body design. Adjustable seat height and depth. Adjustable back height and angle. Tilt mechanism with lock and angle tension control. Height and width adjustable arms. Injection moulded high density bio-foam cushions. Black. **HZN 350504** (350504)

**E Overtime 350™ Mesh High Back Multi-Tilter Chair**  
 For users of above average height and/or weight, up to 350 lbs. Multi-tilt mechanism. High comfort seat made from Ultracell high density, highly resilient foam. Height and width adjustable arms with sliding, rotating and lockable armcaps. Features include tension adjustment, chair tilt lock, lumbar height adjustment, waterfall seat edge, contoured cushions. Adjustable seat angle and height. Sliding seat depth adjustment. Dual wheel carpet casters. Fabric upholstery. Made in Canada. Certified by Greenguard. Black. **GLB 829739** (829739)

**F Work Smart™ EC Executive Armchair**  
 High back executive eco-leather chair for bigger and taller persons (max 350 lb). Padded loop arms and chrome base. 360° swivel seat. Pivot tilt with tilt tension and tilt-lock. Black. **OSP EC1283CEC3** (308635)



**E** **OfficestoGo**



**F**  **OFFICE STAR® PRODUCTS**



## A High Back Tritek Ergo-Select Multi-Tilter Armchair

The unique upper back shape enables free lateral movement. Schukra™ depth adjustable lumbar area is standard. Dual density foam spine pad embedded in the back of the chair forms to the user's shape. Black base and frame. Standard seat. Black.  
**GLB 74823TC74** (506444)

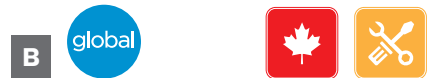

## B Obusforme Comfort High Back Multi-Tilter With Schukra™

High back multi-tilter with Schukra™ depth adjustable lumbar support. Ratchet-style back/lumbar height adjustment with 5-1/4" of vertical travel. 3" wide back bar. Soft Descent™ pneumatic seat height adjustment (MD). Independent back angle adjustment. Infinite position tilt-lock control. Infinitely adjustable seat angle with forward and rearward incline. Height and width adjustable "T" arms with soft touch self-skinned urethane adjustable armcaps (G3).  
**GLB 506394** (506394) black

## C ObusForme Comfort™ Armchair

High back multi-tilter. Compound curve moulded wood veneer back with elastomeric web in back. Pneumatic height adjustment. Seat slider, tilt tension adjustment. Tilt tension adjustment with tilt-lock control. Width adjustable G3 arms slide forward and backward. Armcaps articulate inwards 360° and slide over top of the seat to narrow space between arms. Mock-leather. Black.  
**GLB 138081** (138081) black  
**GLB 377010** (377010) haze



## D ObusForme Comfort™ Armchair

Medium back multi-tilter. Compound curve moulded wood veneer back with elastomeric web in back. Pneumatic height adjustment. Seat slider, tilt tension adjustment. Tilt tension adjustment with tilt-lock control. Width adjustable G3 arms slide forward and backward. Armcaps articulate inwards 30° and slide over top of the seat to narrow space between arms. Terrace fabric. Black.  
**GLB 12413TC74B** (424622)

## E Avro MVL3103 Multi-Tilter Chair

Black mesh back with upholstered seat. Multi-tilt mechanism. Features include tension adjustment, chair tilt lock, lumbar height adjustment, waterfall seat edge, contoured cushions. Adjustable seat angle and height. Adjustable arm height. Sliding seat depth adjustment. Limited lifetime warranty. Dimensions: 26 x 27 x 39-1/2" H. Made in Canada. Certified by Greenguard.  
**GLB 376756** (376756) black  
**GLB 376715** (376715) sand  
**GLB 376749** (376749) grey



## F Ibx MVL2803 Multi-Tilter Chair

Black mesh back with upholstered seat. Multi-tilt mechanism. Features include tension adjustment, chair tilt lock, lumbar height adjustment, waterfall seat edge, contoured cushions. Adjustable seat angle and height. Adjustable arm height. Limited lifetime warranty. Dimensions: 26 x 27 x 39-1/2" H. Black. Certified by Greenguard and Bifma.  
**GLB 315721** (315721)



**A** CHAISES HORIZON SEATING  



**B** CHAISES HORIZON SEATING  

**A Cierra™ Armchair**

Medium back multi-tilter. Seat height, depth and forward angle adjustments. Back height and angle adjustments. Tilt tension control and multiple lock control. Injection-molded bio-foam cushions. Arm height, width adjustments. Fabric upholstery. Black. **HZN 377358** (377358)

**B Cierra™ Petite Armchair**

Medium back. Designed for small people. 17" seat and back. Seat height, depth and angle adjustments. Tilt mechanism with tension control and multi-position tilt-lock. Height and width adjustable arms. Cushions filled with high density injected biofoam. Fabric upholstery. Black. **HZN 377341** (377341)

**C Overtime MVL2756 High Back Multi-Tilter Chair**

Multi-tilt mechanism. Features include tension adjustment, chair tilt lock, lumbar height and back angle adjustment, waterfall seat edge, contoured cushions. Adjustable seat angle and height. Adjustable arm height and width. Limited lifetime warranty. Dimensions: 26 x 24-1/2 x 42" H. Black. Certified by Greenguard. Black. **GLB 138115** (138115) synderne luxhde **GLBMVL2756BF** (138107) upholstered in fabric



**C** OfficestoGo  



**D** OFFICE STAR® PRODUCTS 

**D Pro-Line II® ProGrid® Executive Armchair**

High back. Breathable back with built-in lumbar support. Pneumatic seat height adjustment. Multi-function control with seat slider forward pitch and adjustable tilt tension. Fixed back height. Height and width adjustable arms with PU pads. Dual wheel carpet casters. Black. **OSP 92892-30** (308668)

**E OTG11950 Medium Back Armchair**

Features multi-tilter mechanism and infinite position tilt lock. Height adjustable arms. Seat slider and seat depth adjustment. External ratchet back height adjustment. Height adjustable arms. Fabric upholstery. Black. **GLB OTG11950B** (436857)

**F Full-Time MVL2900 Medium Back Multi-Tilter Chair**

Upholstered in fabric. Multi-tilt mechanism. Features include tension adjustment, chair tilt lock, lumbar height and back angle adjustment, waterfall seat edge, contoured cushions. Adjustable seat height. Adjustable arm height and width. Limited lifetime warranty. Dimensions: 24-1/2 x 25 x 41" H. Black. Certified by Greenguard. **GLB MVL2900BF** (315614)



**E** OfficestoGo 



**F** OfficestoGo  



## A Six 31 OTG11631B Medium Back Operator Chair

Operator mechanism. Independent back angle and seat angle adjustment. Infinite position tilt lock control and tilt tension adjustment. Back height adjustment. Height adjustable T-style arms with durable self-skinned urethane armcaps. Dual wheel carpet casters. Pneumatic seat height adjustment. Black.  
**GLB OTG11631B** (315713)



## B ProGrid® Armchair

Medium back with mesh. Dual-function (back angle/forward tilt). Multi-tilter. Adjustable arms. Seat and back angles are infinitely adjustable. Pneumatic height adjustment. Fabric upholstery. Black.  
**OSP 92343-30** (253997)

## C Martini Operator Armchair

High back multi-tilter. Pneumatic height adjustment. Seat depth adjustment. Height and depth adjustable arms. Fabric upholstery. Black.  
**GLB 576660** (576660)

## D Granada Deluxe™ Ergonomic Armchair

Medium back. Compound curved back and seat to comfortably match body shape. 2-layer foam seat. Multi-tilter with tilt lock and tilt tension control. Sliding seat depth adjustment. Depth adjustable lumbar support. Height and width adjustable T arms with soft touch self-skinned urethane armcap. Fabric upholstered. Black.  
**GLB 576678** (576678) mid-back  
**GLB 576686** (576686) high-back

## E Six 13 OTG11613B Medium Back Multi-Tilter Chair

Upholstered in fabric. Multi-tilt mechanism. Features include tension adjustment, chair tilt lock, lumbar height and back angle adjustment, waterfall seat edge, contoured cushions. Adjustable seat height. Adjustable arm height. Limited lifetime warranty. Dimensions: 25-1/2 x 24x 39" H. Black. Certified by Greenguard.  
**GLB OTG11613B** (769760)

**A** **OfficestoGo**



**B** **OFFICE STAR® PRODUCTS**



**C** **Martini**



**D** **global**



**E** **OfficestoGo**





**A** LORELL



**B** LORELL



**A Operator Chair with Headrest**

High mesh back. Multi-tilter mechanism with infinite position tilt-lock and tilt-tension adjustment. Infinite position back and seat angle adjustment, including forward tilt. Back height adjustment. Height and width adjustable arms. Extra thick cushions. Fabric upholstery. Black. 28-1/2 x 28-1/2 x 51"H. Covered by Lorell limited 5-year warranty. **LLR 60324** (1019264)

**B Executive High-Back Swivel Chair**

High mesh back. Synchro-tilt mechanism with infinite position tilt-lock and tilt-tension adjustment. Infinite position back and seat angle adjustment, including forward tilt. Back height adjustment. Height and width adjustable arms. Extra thick cushions. Fabric upholstery. 28-1/2 x 28-1/2 x 45"H. Covered by Lorell limited 5-year warranty. **LLR 86205** (1019207)

**C Operator Chair**

Mesh back. Multi-tilter mechanism with infinite position tilt-lock and tilt-tension adjustment. Infinite position back and seat angle adjustment, including forward tilt. Back height adjustment. Height and width adjustable arms. Extra thick cushions. Fabric upholstery. 28-1/2 x 28-1/2 x 45"H. Covered by Lorell limited 5-year warranty. **LLR 86200** (1019140) high back  
**LLR 86201** (1019249) mid back



**C** LORELL



We are here for you! Don't hesitate to contact your local representative for more information about our products and services.

**BUILD YOUR OWN CHAIR!**

Select your Frame and Seat separately to match your unique style.



**D** LORELL



**E** LORELL

**D Chair Frame**

Black. Covered by Lorell limited 5-year warranty. Seat sold separately.  
**High back with synchro-tilt - 28-1/2 x 28-1/2 x 45"H**  
**LLR 86212** (1019173)  
**High back - 28-1/2 x 28-1/2 x 45"H**  
**LLR 86210** (1019165) high back  
**Mid-back - 28-1/2 x 23-1/2 x 40-1/2"H**  
**LLR 86211** (1019215) mid back

**E Seat**

Covered by Lorell limited 5-year warranty. Frame sold separately.  
**Bonded leather**  
**LLR 86213** (1019397) black  
**Fabric**  
**LLR 86219** (1019348) black  
**LLR 86215** (1019356) green  
**LLR 86214** (1019389) red

**A Conjure High Back Operator Chair**

High back. Mesh back. Fabric upholstered seat. Multifunction mechanism features independent seat and lumbar support, tilt tension adjustment seat slider to adjust seat depth and a forward tilt position for perching. Black. 26-3/4 x 26 x 44"H. Covered by Lorell limited 5-year warranty. **LLR 62000** (1019199)



**B Conjure Mid-Back Operator Chair**

Mid-back. Mesh back. Fabric upholstered seat. Multifunction mechanism features independent seat and lumbar support, tilt tension adjustment seat slider to adjust seat depth and a forward tilt position for perching. Black. 26-3/4 x 26 x 39-1/2"H. Covered by Lorell limited 5-year warranty. **LLR 62001** (1019231)



**BUILD YOUR OWN CHAIR!**  
Select your Frame and Seat separately to match your unique style.

**C Conjure Chair Frame**

High back. Multifunction mechanism features independent seat and lumbar support, tilt tension adjustment seat slider to adjust seat depth and a forward tilt position for perching. 26-3/4 x 26 x 44"H. Black. Covered by Lorell limited 5-year warranty. Seat sold separately. **LLR 62002** (1019181)





**A Part-Time 2837F Operator Chair**

Low back, armless. Pneumatic height adjustment. Infinite back angle adjustment. Back height adjustment. Fabric upholstery. Black.  
**GLB 253849** (253849)



**B Offices to Go™ Cobalt Armchair**

Medium back. Tilt mechanism with lock and tension control. Waterfall seat edge. Height adjustable arms. Leather upholstered. Black.  
**GLB 315549** (315549)

**C Part-Time Task Armchair**

Height adjustable arms. Seat depth adjustment. Pneumatic seat height adjustment. Dual wheel carpet casters. Fabric upholstery. Black.  
**GLB 315747** (315747)

**D Part-Time Task Chair**

Seat depth adjustment. Pneumatic seat height adjustment. Dual wheel carpet casters. Fabric upholstery. Black.  
**GLB 315754** (315754)

**E Activ™ A-47 Armchair**

Mid-back with mesh fabric. Pneumatic seat height adjustment. Adjustable lumbar support. 2:1 synchro-tilter mechanism with lock and angle tension control. Height adjustable arms. Black.  
**HZN A-47** (350520)

**A** **OfficestoGo**



**B** **OfficestoGo**



**C** **OfficestoGo**



**D** **OfficestoGo**



**E** **CHAISES HORIZON SEATING**



**A Ibex Mesh Medium Back Synchro-Tilter Armchair**

Mesh back with upholstered seat. Synchro-tilter mechanism. Features include tension adjustment, chair tilt lock, lumbar height adjustment, waterfall seat edge, contoured cushions. Adjustable seat height. Adjustable arm height. Leather upholstery. Black. Limited lifetime warranty. Dimensions: 26 x 26-1/2 x 39-1/2" H. Made in Canada. Certified by Greenguard and Bifma.  
**GLB MVL2801BL** (506253)

**B Bolt OTG11510 Tilter Chair**

Mesh back with fabric upholstered seat. Tilter mechanism. Features include tension adjustment, chair tilt lock, waterfall seat edge, contoured cushions. Adjustable seat height. Limited lifetime warranty. Dimensions: 25 x 21-1/2 x 35-1/2" H. Black. Certified by Greenguard.  
**GLB 506287** (506287)

**C Operator Armchair**

Pneumatic height adjustment. Arm and seat height adjustments. Fabric upholstery.  
**GLB 576769** (576769) black

**D Activ™ A-44 Office Chair**

Mid-back mesh. Height adjustable lumbar support. Height and lateral adjustable arms. Weight capacity 250 lb. Carpet casters. 5-year limited warranty. Sold by each. Black. Made in Canada.  
**HZN A-44** (829566)

**E Activ™ A-88 Office Chair**

Mid/high mesh back. Synchro-tilt mechanism with a 3:1 ration. Vertical position lock. Height/pivot and telescope adjustable arms. Height adjustable lumbar support. Weight capacity 250lbs. Dual wheel casters good for carpet and hard floor. 5-year limited warranty. Sold by each. Black. Made in Canada.  
**HZN A-88** (829567)



**A** **OfficestoGo**  

**B** **OfficestoGo** 



**C** **OfficestoGo** 

**D**    

**E**    



**A**

**OfficestoGo**



**B**

**OfficestoGo**



**A Petra™ Mesh Back Tilter Chair**

Breathable mesh back. Tilter mechanism. Features include tension adjustment, chair tilt lock, waterfall seat edge, contoured cushions. Adjustable seat height. Height adjustable arms. Limited lifetime warranty. Greenguard certified. Black.  
**GLB OTG11320B** (829729)

**B Zim™ Mesh Back Synchro-Tilter Chair**

High mesh back. Features include synchro-tilt mechanism, multi-position tilt lock and weight sensing tension, waterfall seat edge, contoured cushions. Adjustable seat height. Sliding seat depth adjustment. Height adjustable arms. Limited lifetime warranty. Greenguard certified. Black.  
**GLB OTG11351B** (829730)

**C Lumi™ Mesh Back Task Chair**

Contoured back frame and a thick seat cushion. Synchro-tilter mechanism. Features include tension adjustment, chair tilt lock, waterfall seat edge, contoured cushions. Adjustable seat height. Height adjustable T-arms with sliding and rotating armcaps. Limited lifetime warranty. Greenguard certified. Black.  
**GLB829731** (829731)

**D Soho Mesh Back Task Chair**

Mesh back chair with upholstered seat. Pneumatic adjustable-height seat with tilt lock. Adjustable tilt tension. Black. 25 x 26 x 39.5 in. H. Covered by Lorell limited 3-year warranty.  
**LLR 99846** (1053941)



**C**

**OfficestoGo**



**D**

**LORELL**



**E Milenia Series Task Armchair**

Moulded seat and back. Adjustable-height and width armrest. Arms are removable for classic task use. Pneumatic seat-height adjustment. Height-adjustable back. For users up to 250 lb. Black. 24 x 24 x 38 in. H. Coverd by Lorell limited 5-year warranty.  
**LLR 80004** (1054063)

**F Soho Mid-Back Mesh Armchair**

Mesh back with fabric upholstered seat. Adjustable-height lumbar support. Pneumatic seat-height adjustment. Tilt tension and tilt lock control. Locks in straight up position. Height adjustable armrests. Black. 24 x 25 x 42.5 in. H. Covered by Lorell limited 3-year warranty.  
**LLR 41842** (1054907)



**E**

**LORELL**



**F**

**LORELL**



## A Ibx Stackable Guest Chair

Mesh back with upholstered seat. Wall saver frame. Polymer armcaps. Stacks up to 5 high. Fabric upholstery.  
**GLB 253807** (253807) ebony  
**GLB253823** (253823) admiral



**A** **OfficestoGo**

## B Offices to Go™ Ibx Stackable Guest Chair

Upholstered back and seat. Wall saver frame. Polymer armcaps. Stacks up to 5 high. Fabric upholstery. Black.  
**GLB 253831** (253831)

## C Pro-Line® II ProGrid® Stacking Visitor Chair on Casters

Breathable back with built-in lumbar support. Padded seat. Nylon armrests. Titanium finish frame. Stackable. Black.  
**OSP 85640-30** (308536)

## D Pro-Line® II Stacking Visitor Chair

Ventilated plastic wrap around back. Padded seat. Titanium finish frame. Stackable. Black.  
**OSP 8620-30** (308676)

## E Pro-Line® II ProGrid® Visitor Chair

Breathable back. 4 legs. Titanium finish base. Stackable. Fabric upholstery. Black.  
**OSP 86724-30** (308692)

## F Pro-Line® II ProGrid® Stacking Visitor Chair

Breathable back with built-in lumbar support. Padded seat. Nylon armrests. Titanium finish frame. Stackable. Black.  
**OSP 85670-30** (308833)

## G Offices to Go™ Dash Guest Armchair

Air-flow mesh back. Welded steel frame. Generous proportions. Fabric upholstery. Black.  
**GLB 0TG11760B** (315622)



**B** **OfficestoGo**



**C** **OFFICE STAR® PRODUCTS**



**D** **OFFICE STAR® PRODUCTS**



**E** **OFFICE STAR® PRODUCTS**



**F** **OFFICE STAR® PRODUCTS**



**G** **OfficestoGo**





**A** **Offices to Go**



**B** CHAISES **HORIZON** SEATING

**A Offices to Go™ IbeX Guest Armchair**

Mesh back. On casters. Bonded leather seat. Polymer armcaps. Greenguard certified. Black.  
**GLB 351700** (351700)

**B Stackable Guest Chair**

Mesh back with upholstered seat. Fiberglass reinforced nylon armrests. Black.  
**HZN A-20** (375642)

**C Activ A-19 Visitor Armchair**

Mesh back with high density, high resiliency foam padded seat. 4-legged round tube base. Injection molded polypropylene armcaps. foam cushion seat. Stacks 5 high. Black.  
**HZN A-19** (429209)

**D IbeX Guest Chair**

Multipurpose guest seating. Welded steel frame. Generous proportion. Polymer armcaps. Upholstered back. Luxhide bonded leather seat. Comes fully assembled. Greenguard certified. Black.  
**GLB 507285** (507285)

**E Guest Armchair**

Breathable mesh back. Seat upholstered in fabric. Power-coated steel frame. Stackable up to 4 high. For users up to 250 lb. Black. 25 x 20 x 32 in. H. Covered by Lorell limited 5-year warranty.  
**LLR 23100** (1053727)



**C** CHAISES **HORIZON** SEATING



**D** **Offices to Go**

**F Solo Plus Guest Armchair**

Contoured seat and back, waterfall seat edge and upholstered armcaps provide extended comfort. Sled base. Black.  
**GLB 576777** (576777)

**G Stackable Guest Chair**

Mesh back and vinyl upholstered and seat. Fiberglass reinforced nylon armrests. Black.  
**HZN A-20-D045** (805607)



**E** **LORELL**



**F** **global**



**G** CHAISES **HORIZON** SEATING





**A Activ™ Series Guest Chair With Casters**

Contoured, low, mesh backrest. 4-legged rectangular tube frame. Injection molded black polypropylene arm caps. High density, high resiliency foam cushions. Waterfall seat edge design. Standard with hard floor casters. 18.5 x 19.5 x 16 in. 20 lb. Black.  
**HZN A-20C** (829568)



**B Guest Chair**

Mesh back and vinyl upholstered seat. Rectangular tube frame with injection molded polypropylene arms. Four legged base. Hard surface casters. Black.  
**HZN A20C-D045** (829569)



**C Activ™ Visitor Chair**

Seat and backrest in bonded leather. Comfortable and durable foam. Black.  
**HZN A-302** (829570)

**D Centro Guest Armchair**

Luxhide Bonded leather. Guest chair soft cushions flat steel tube frame. Upholstered arm caps. GreenGuard certified. Black. 24.5 x 27 x 33.5 in. H.  
**GLB 0TG3915BL** (1018910)

**E Guest Armchair**

Leather-upholstered, padded seat and back. Metal frame with a powder-coat finish. Plastic arm caps. Sled base. For users up to 250 lb. 24.75 x 26 x 33.5 in. H. Black.  
**LLR 84577** (1053446)



**F Ashmont Guest Chair**

Deep and soft cushions offer plush comfort. Sled base - oval steel tube frame. Upholstered arm caps. Luxhide Bonded leather. GreenGuard certified. Black.  
**GLB MVL2782BL** (507293)





**A** **OfficestoGo**



**B** **OfficestoGo**

**A IbeX Drafting Chair**

Task mechanism. Pneumatic seat height adjustment. Upholstered seat and mesh back. Dual wheel carpet casters. Height adjustable chromed footrest. Black.

**GLB 376632** (376632) without armrest  
**GLB 376640** (376640) with armrests

**B Beta Drafting Chair**

Posture-task mechanism. Infinite back angle adjustment. Back height adjustment. Pneumatic seat height adjustment. Thick, soft cushions for enhanced comfort. Height adjustable chromed footrest. Dual wheel carpet casters. Black.

**GLB 376566** (376566) without armrests  
**GLB 376590** (376590) with armrests

**C Mid-Back Drafting Armchair**

Upholstered seat and mesh back. Pneumatic seat height adjustment. Chrome adjustable footrest. Black. 26 x 21 x 50 in. H. Covered by Lorell limited 5-year warranty.

**LLR 86801** (1019158)

**D Drafting Chair**

Moulded seat and back. Adjustable seat height from 22 to 32 in. Adjustable chrome footrest. 24 x 24 x 50.5 in. H. Covered by Lorell limited 5-year warranty.

**LLR 80008** (1054089) black



**C** **LORELL**



**D** **LORELL**



**E Shoptech™ Industrial Chair**

With stool kit. Polyurethane seat and backrest. Pneumatic height adjustment. Infinite position backrest angle adjustment. Black.

**HZN 2000-14-SK** (754192)

**F Shoptech™ Industrial Task Stool**

Designed for sit-stand work situations. Pneumatic seat height adjusts from 22 to 32". Polyurethane seat with low back support. Black.

**HZN 2301PC1000** (112144)

**G MVL File Buddy Stool**

Swivel stool with black vinyl upholstery. Pneumatic seat height adjustment. 12 in. diameter seat. Twin carpet casters.

**GLB MVL11070** (436873) 10 in.  
**GLB MVL110570** (436865) 5 in.



**E** **CHAISES HORIZON SEATING**



**F** **CHAISES HORIZON SEATING**



**G** **OfficestoGo**

## A Zenergy™ Ball Chair

Designed with an (anti-burst) exercise ball, provides movement that not only helps you sit comfortably, but also helps you concentrate and supports better posture and balance. It's like using an exercise ball, but with the added benefit of the chair being stationary, so it won't roll away when you're trying to take a seat. Use Zenergy as a complementary chair to your everyday task seating. 23" high. Four powder coated legs. Pump included. Greenguard Certified.

**SAF 4750BL** (511774) black  
**SAF 4750CI** (511782) crimson  
**SAF 4750GS** (511790) grass



## B IbeX™ Armless Bar Stool

Classic air mesh back. Fully upholstered seat. Features include waterfall seat edge, contoured cushions. Stackable up to 5 high. Limited lifetime warranty. Greenguard certified. Black.

**GLB 829732** (829732)



## C Sit-Stand Swivel Stool

180 degree swivel with auto return function. Adjustable height for counter or adjustable table use. Contoured seat design. Molded foam seat cushion. Handle for easy mobility. 32 x 13 x 14.5 in. Black.

**HZN A-91P** (584995)



## D Felt Pads

Heavy-duty. Round.  
**SDU 9952** (700088) 1" dia. (16)  
**SDU 9953P** (236091) 1-1/2" dia. (8)

## E Felt Pads

Heavy-duty. Rectangular. 4-1/2 x 6".  
**SDU 9950** (700096)

## F Flexi-Felt® Floor Protector

Protects your floor and reduces up to 90% of furniture scraping noises. Easy to install. Package of 4.

**FFC 6122B** (337337) 22 mm (7/8")  
**FFC 6331B** (337345) 22-31 mm (7/8 - 1-1/4")



## G Chair Slippers

Prevents irritating noise generated by unpadding chair legs. Package of 4. Assorted colours.

**MGE 745950** (745950)

## H Caster for Carpet

Black caster and head. 2" (50 mm) dia.

**SDU 9694** (700104)

## I Caster for Hard Floor

Twin-wheel urethane casters. 2-1/2"-diameter.

**SDU 100077** (773333)

## J Twin Wheel Caster

Soft tread for hard surfaces. 2-1/2 in. (64mm).

**MGE 539270** (539270)



MERANGUE





**A** **deflecto**



**B** **LORELL**

**A EconoMat® Chair Mat for Hard Floor**

Non-studded vinyl. Free and Clear® non-orthophthalate, non-cadmium formula promotes a healthy work environment. Straight edge. Greenguard gold certified. Clear.

- 46 x 60 in. - rectangle**  
DEF CM21442F (112128)
- 46 x 60 in. with 25 x 12 in. wide lip**  
DEF CM21432F (112110)

**B Chair Mat for Hard Floor**

Non-studded vinyl. Protects carpets and hard floors from wear and tear caused by casters. Slip-resistant and scuff-resistant. Rolled and individually boxed. Covered by Lorell limited lifetime warranty.

- 36 x 48 in. - rectangle**  
LLR 82825 (1023449)
- 46 x 60 in. - rectangle**  
LLR 82827 (1023464)
- 45 x 53 in. with 25 x 12 in. wide lip**  
LLR 82826 (1023457)

**C Heavy-Duty Chair Mat for Hard Floors**

Non-studded thick vinyl. Designed for hard floors including wood, vinyl and tile. Protects floors from chair scuffs and caster damage. Straight edge. 45 x 53 in. with 25 x 12 in. wide lip.

- LLR 69167 (1023860)



**C** **LORELL**



**D** **deflecto**

**D EconoMat® Chair Mat for Low Pile Carpet**

Studded vinyl. For use on low pile commercial carpets up to 1/4 in. thick. Free & Clear® non-orthophthalate, non-cadmium formula promotes a healthy work environment, and offers exceptional durability. Straight edge. Greenguard Gold Certified. One year limited warranty. 45 x 53 in. with 25 x 12 in. wide lip.

- DEF CM11232 (501866)

**E Chair Mat for Low Pile Carpet**

Studded vinyl. For use on low pile commercial carpets up to 1/4 in. thick. Slip-resistant and scuff-resistant. Bevelled edge. Covered by Lorell limited lifetime warranty.

- 46 x 60 in. - rectangle**  
LLR 69160 (1023241)
- 36 x 48 in. with 19 x 10 in. standard lip**  
LLR 69157 (1023225)
- 45 x 53 in. with 25 x 12 in. wide lip**  
LLR 69158 (1023233)
- 45 x 60 in. with 25 x 12 in. wide lip**  
LLR 69159 (1023259)

**F Economy Chair Mat for Low Pile Carpet**

Studded lightweight vinyl. For use on low pile commercial carpets up to 1/4 in. thick. Slip-resistant and scuff-resistant. Bevelled edge. Covered by Lorell limited lifetime warranty. Clear.

- 46 x 60 in. - rectangle**  
LLR 02158 (1023431)
- 36 x 48 in. with 19 x 10 in. standard lip**  
LLR 02156 (1023308)
- 45 x 53 in. with 25 x 12 in. wide lip**  
LLR 02157 (1023316)



**E** **LORELL**



**F** **LORELL**

## A RollaMat® Chair Mat for Medium Pile Carpet

Studded vinyl. Free & Clear® non-orthophthalate, non-cadmium formula promotes a healthy work environment, and offers exceptional durability. Easy-glide rolling surface for effortless chair movement. For frequent use on medium pile carpets. Beveled edge. Greenguard Gold Certified. Limited lifetime warranty.

**36 x 48 in. with 19 x 10 in. standard lip**

**DEF CM15113** (501833)

**45 x 53 in. with 25 x 12 in. wide lip**

**DEF CM15233** (501841)

## B Medium Pile Chair Mat

Studded vinyl. For use on medium pile carpets up to 1/2 in. thick. Smooth edge designed for easy on-off chair movement. Covered by Lorell limited lifetime warranty. Clear.

**46 x 60 in. - rectangle**

**LLR 25754** (1023290)

**45 x 53 in. with 25 x 12 in. wide lip**

**LLR 69166** (1023853)

**46 x 60 in. with 25 x 12 in. wide lip**

**LLR 69165** (1023845)

## C L-Workstation Chair Mat for Medium Pile Carpet

Studded vinyl. For use on medium pile carpets up to 1/2 in. thick. Designed for corner workstation. Smooth edge designed for easy on-off chair movement. Covered by Lorell limited lifetime warranty. Clear. 60 x 66 in. with 20 x 12 in. lip.

**LLR 69156** (1023266)

## D Heavy-Duty Chair Mat for Medium Pile Carpet

Thick studded vinyl. For use on medium pile carpets up to 1/2 in. thick. Textured top makes mat slip and scuff resistant. Clear vinyl. Covered by Lorell limited lifetime warranty. 46 x 60 in. - rectangle.

**LLR 69164** (1023837)

## E Plush Carpet Chair Mat

Studded vinyl. For use on plush carpets up to 3/4 in. thick. Smooth edge designed for easy on-off chair movement. Covered by Lorell limited lifetime warranty. Clear.

**36 x 48 in. with 19 x 10 in. standard lip**

**LLR 25757** (1023100)

**45 x 53 in. with 25 x 12 in. wide lip**

**LLR 25756** (1023118)

**46 x 60 in. with 25 x 12 in. wide lip**

**LLR 25755** (1023126)

## F Polycarbonate Chair Mat

Durable and resilient studded polycarbonate. Used for low-pile carpets and hard floors. Covered by Lorell limited lifetime warranty.

**36 x 48 in. - rectangle**

**LLR 69703** (1023332)

**45 x 53 in. - rectangle**

**LLR 69704** (1023358)

**46 x 60 in. - rectangle**

**LLR 69705** (1023373)

## G DuoMat® Chair Mat for Hard or Carpeted Floor

Clear® non-orthophthalate, non-cadmium formula promotes a healthy work environment, and offers exceptional durability. Exclusive SuperGrip® coating, mat stays where you put it. 2x better grip than our standard studs on carpet. Designed for carpet and hard floors. Easy-glide rolling surface for effortless chair movement. Straight edge. Greenguard Gold Certified. Limited lifetime warranty.

**36 x 48 in. - rectangle**

**DEF CM23142DUO** (501809)

**46 x 60 in. - rectangle**

**DEF CM23442FDU** (501825)

**45 x 53 in. with 25 x 12 in. wide lip**

**DEF CM23232DUO** (501817)



# craft + ionic

exceptional quality. affordable price.



Craft™ is a modular seating system that is durable, easy to configure and designed for a variety of spaces. The small collection has infinite layout possibilities which can be reconfigured to adapt to your changing business needs.

Pair your Craft seating with the Ionic™ desk suite to support a wide range of workplace applications. From private offices, boardrooms, reception areas or collaborative spaces, Ionic offers solutions that will exceed your expectations and keep you on budget. Ionic and Craft are easy to install and built to last.

**OfficestoGo**

OFFICESTOGO.COM

## A Outlines Reception Desk

Makes privacy easy and attractive. Transaction tops are 1 in. All tops are thermally fused laminate on a 45 lb industrial particle board core. Reed style polycarbonate screen with powder coated aluminum top and bottom mounting rails. Aluminum mounting posts with PVC filler strips. Available in 3 finishes. 72 x 72 in.

**HTW 829801** (829801) evening zen

**HTW 829802** (829802) grey dusk

**HTW 829803** (829803) winter wood



EVENING ZEN



GREY DUSK



WINTER WOOD



## B Reception Desk

Two-tone waterfall design transaction top. Transaction shelf bottom, cubby dividers and side panels are pure white. Tops and backs match unit colour. Surfaces are laminated with thermal fused melamine. Matching protective 3mm PVC radius edge detail. Full modesty panel. Leveling glides. Grommet for wire management. Non-handed reception return for L-shape sold separately.

**Reception desk**

**HTW INV3072EZW** (1017938) evening Zen

**HTW INV3072GDW** (1017946) grey dusk

**36 in. bridge return**

**HTW INV2436EZW** (1017904) evening zen

**HTW INV2436GDW** (1017896) grey dusk

**42 in. bridge return**

**HTW INV2442EZW** (1017912) evening zen

**HTW INV2442GDW** (1017920) grey dusk

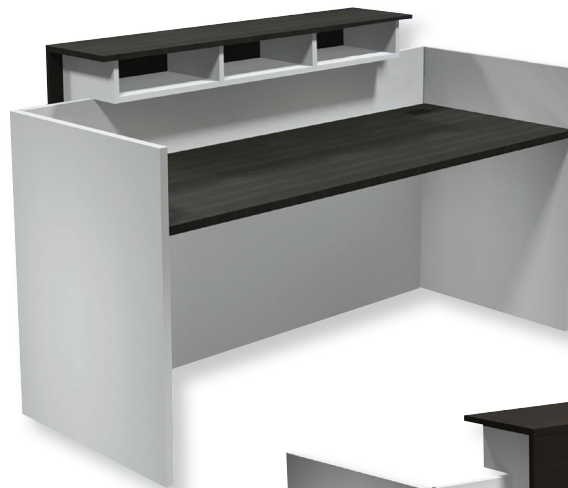



**OfficestoGo**



**A**

**A Suburb Three Seat Sofa**

Thick, plush cushions are reversible and removable. Arms taper forward feature radius ends. Freestanding. Tapered black wooden legs. Covered in Luxhide bonded leather. Certified by Greenguard. Black. **GLB 829735** (829735)



**B**

**OfficestoGo**

**B Suburb Two Seat Sofa**

Thick, plush cushions are reversible and removable. Arms taper forward feature radius ends. Freestanding. Tapered black wooden legs. Covered in Luxhide bonded leather. Certified by Greenguard. Black. **GLB 829734** (829734)



**C**

**OfficestoGo**

**C Suburb Club Chair**

Thick, plush cushions are reversible and removable. Arms taper forward feature radius ends. Freestanding. Tapered black wooden legs. Covered in Luxhide bonded leather. Certified by Greenguard. Black. **GLB 829733** (829733)



## A Accession Sofa

Features bonded leather with Mahogany-stained legs. 5-year limited warranty. 75 x 34-1/2 x 31-1/4"H. Black.  
**LLR 68950** (1054501)



## B Accession Loveseat

Features bonded leather with Mahogany-stained legs. 5-year limited warranty. 55 x 34-1/2 x 31-1/4"H. Black.  
**LLR 68951** (1054477)

## C Accession Club Chair

Features bonded leather with mahogany-stained legs. 5-year limited warranty. 36 x 34-1/2 x 31-1/4"H. Black.  
**LLR 68952** (1054428)

## D Accession Club Chair with Shelf

Features bonded leather with mahogany-stained legs. 5-year limited warranty. 36 x 34-1/2 x 31-1/4"H. Black.  
**LLR 68953** (1054386)

## E Club Chair

Supportive back, nearly full-height arms and a thickly cushioned seat. 31.5 x 28.75 x 30.75"H. Black.  
**LLR 82096** (1053537) fabric  
**LLR 82098** (1053529) leather





**A** LORELL

**A Guest Chair**

Mahogany wood frame. Upholstered arms. Leather seat.  
24 x 25 x 35-1/2"H. Black.  
**LLR 20027** (1054759)

**B Wood Guest Chair**

Wood and bonded leather create the ideal guest chair. Solid wood frame construction provides durability and strength. 24 x 25-5/8 x 33-1/4"H. 5-year limited warranty.  
**LLR 40201** (1053818) black/espresso  
**LLR 40202** (1053826) black/mahogany



**C Soda Lounge Chair**

Both contemporary and retro design. Back design offers flexible movement. Generous proportions allow for a variety of seating positions. Chrome frame with clear polycarbonate glides. Backrest and seat fully upholstered and covered with fabrics. Black.  
**GLB 829736** (829736)



**B** LORELL

**D Soda Coffee Table**

1 in. thick thermally fused laminate surface with 2 mm matching edge band. Chrome frame with polycarbonate glides suitable for carpets, rubber, or concrete flooring. 30 in. diameter. White.  
**GLB 829737** (829737)



**E Duet™ Stackable Tables**

Suitable for any multi-use learning space that requires quick setup and minimal storage. Polymer top. Stackable steel frame, chrome finish.  
**GLB 576793** (576793) black  
**GLB 576801** (576801) ivory



**C** Offices to Go



**D** Offices to Go



**E** global



## A Metal Coat Rack

4 double hooks with chrome finish. Stabilizing levelling glides.  
Height: 60 in. Black.  
**GLB COS2BLK** (5595)

## B Coat Rack

8 hooked arms with rounded edges to help protect garments.  
Tubular steel construction with scratch-resistant. Powder coat finish.  
15 in diameter steel base. Height: 68 in. Black.  
**SAF 4241BL** (439588)

## C Coat Rack

Features four coat pegs and four hooks for accessories.  
Powder-coat finish for durability. Height: 63 in. Metal frame, Silver.  
**LLR 02587** (1053305)

## D Onyx™ Mesh Wall Rack

Five double hooks. Round hooks help protect garments.  
Durable powder coat finish. Black.  
**SAF 6403BL** (439562)

## E Wall Rack Coat Hook

Chrome-plated double steel hooks with ball tips to help protect garments. Wall mounting hardware included. Chrome.  
**SAF 4161** (439638) 3 hooks (18")  
**SAF 4162** (439646) 6 hooks (36")

## F Over-The-Door Coat Hook

Satin aluminum base with chrome hooks. Double steel hook with ball tips help protect garments. Fits over doors up to 1-3/4" thick.  
**SAF 4166** (526798)



**A** global



**B** SAFCO



Find Cubicle Panel Coat Hooks on **page 249**



**C** LORELL



**D** SAFCO



**E** SAFCO



**F** SAFCO



**A Rectangular Folding Table**

Resin surface with rounded corners. Granite finish.  
**DRH A6458** (205674) 48 x 24 in.  
**DRH A6457** (205690) 60 x 30 in.  
**DRH A6352** (205666) 72 x 30 in.  
**DRH A6321** (205633) 96 x 34 in. folds in center)

**B Rectangular Folding Table**

Made of high density polyethylene. Scratch resistant and weatherproof. Steel legs. For indoors and outdoors use. 29 in. H. Granite. Limited 2-year warranty.  
**HTW TLT2448GN** (1022714) 48 x 24 in.  
**HTW TLT3072GN** (1022722) 72 x 30 in.  
**HTW TLT3096GN** (1022730) 96 x 30 in.



**C Ultra-Lite Rectangular Folding Table**

For light duty use. Made of high density polyethylene. 1 in. tubular steel legs. Powder finish. Indoors or outdoors use. 29 in. H. Limited 5-year warranty.  
**LLR 66657** (1058098) 48 x 30 in.  
**LLR 66656** (1058114) 60 x 30 in.  
**LLR 66655** (1058130) 72 x 30 in.  
**LLR 66654** (1058148) 96 x 30 in.

**D Round Folding Table**

Made of high density polyethylene. Scratch resistant and weatherproof. Steel legs. For indoors and outdoors use. 29 in. H. Granite. Covered by HDL limited lifetime 2-year warranty.  
**HTW TLTR45GN** (1022756) 45 in.  
**HTW TLTR60GN** (1022748) 60 in.



**E Ultra-Lite Round Folding Table**

For light duty use. Made of high density polyethylene. 1 in. tubular steel legs. Powder finish. Indoors or outdoors use. 29 in. H. Limited 5-year warranty.  
**LLR 60327** (1058080) 48 in.  
**LLR 60326** (1058106) 60 in.  
**LLR 60325** (1058122) 71 in.

**F Ultra-Lite Square Folding Table**

For light duty use. Made of high density polyethylene. 1 in. tubular steel legs. Powder finish. Indoors or outdoors use. 29 in. H. Limited 5-year warranty. 36 x 36 in.  
**LLR 60328** (1058072)



**G Table Trolley Cart**

Transports rectangular tables up to 96 in. long. The steel construction features a powder coat finish. Charcoal grey. 30 x 45 x 75 in. H. Covered by Lorell limited 5 years warranty.  
**LLR 65956** (1058007)



# Folding Chairs | Cafeteria and Banquet Furniture

## A Resin Folding Chairs

Made of 100% resin. Set of 6 chairs. Oyster.  
**DRH A6311** (205716)



**B**



## B Toughlite TLT-FC6 Folding Chair

Lightweight ergonomically contoured folding chair. Weight capacity up to 330lbs. Box of 6. Putty.  
**HTW TLTFC6** (1019827)



## C Translucent Folding Chair

225 lb weight capacity. Heavy-duty tubular frame. Back rest and seat are made of injection-molded plastic that is translucent. Box of 4.  
**LLR 62530** (1053652)



## E Metal Folding Chair

Upholstered seat and back. Box of 4. Black.  
**DRH F133** (208587)



## F Metal Folding Chair

All metal. Box of 4. Black.  
**DRH F173** (208629)



## G Steel Folding Chair

Padded seat. Box of 4  
**LLR 62501** (1054402) beige  
**LLR 62526** (1053644) black



## H Steel Folding Chair

Padded back and seat. Box of 4. Black.  
**LLR 62532** (1053693)





**A** 



**B** 



**A Sonic Stacking Chair**

Poly seat and back. Armless. Chrome legs. Stackable up to 5 high on floor or 10 high on 6517WS dolly Black.  
**GLB 315432** (315432)

**B Sonic Stacking Chair With Armrest**

Poly back and fabric seat. With armrests. Chrome legs. Stackable up to 5 high on floor or 10 high on 6517WS dolly.  
**GLB 6513WSBLK** (507905) black  
**GLB 6513WSIVC** (507913) ivory

**C Maxx Staxx™ Stackable Chairs**

Contemporary design featuring sturdy elliptical frame. Polypropylene back and seat. Without armrests. Box of 2. Black.  
**HZN A-118** (137976)

**D Maxx Staxx™ Stacking Chair with armrests**

Contemporary design featuring sturdy elliptical frame. Polypropylene back and seat. With armrests. Box of 2. Black.  
**HZN A-118A** (138024)

**E Banquet Chair**

Vinyl upholstery. Black.  
**HZN A-117V** (375725)

**F Stacking Chair**

Vinyl back and seat. Box of 4. Black.  
**LLR 62502** (1054196)

**G Stacking Chair**

Injection molded plastic back and seat. Powder coat tubular frame. Box of 4. Black.  
**LLR 85567** (1054162)



**C**  



**D**  



**E** 



**F**  



**G**  

## A Popcorn Stacking Chair

Flexible backrest and supporting curves ensure comfort even when seated for extended periods. Features a durable 0.5" diameter steel rod frame with no front crossbar. One piece seat-back polypropylene shell. Wallsaver design. 20 x 23.5 x 32.5"H.

**GLB 436238** (436238) black  
**GLB 436345** (436345) ivory

Available in other colours,  
 contact us for more  
 information.



## B Duet™ Armless Stackable Chair

Frame made from durable solid chrome steel rod. Polypropylene seat and back.

**GLB 6621BLKCM** (376053) black  
**GLB 6621IVCCM** (376160) ivory

## C Duet™ Stacking Chair

High-density stacking chair designed by Zooley Chu. Frame is made from durable solid steel rod. Polypropylene seat and backs with fiberglass reinforced nylon arms. Glides are non-marking. A patented ganging feature allows chairs to be effortlessly locked together in neat tidy rows. Can be stacked and stored up to 40 high on an optional mobile dolly. Lifetime warranty.

**GLB 6620BLKCM** (507582) black  
**GLB 6620IVCCM** (507624) ivory

## D Duet™ Ganging Clamps

Available for use on standard armless models. These brackets snap on the front and rear of the sled base allowing these models to connect together in rows. Pack of 2. Black.

**GLB 6626** (507574)



## E Duet™ Stacking Chair Dolly

Stack chairs, with or without arms. Hold up to 40 chairs without arms, or 24 chairs with arms. Large casters and angled handle. Black.

**GLB 6624** (507566)

## F Chair Dolly

For stacking and transporting polypropylene chairs only. Stacks 34 high. Black.

**GLB 6715** (508028)

## G Dolly for Folding Chairs

Holds 42 steel folding chairs or 24 moulded folding chairs. 68 L x 30-3/4P x 35-3/4 in. H. Noir.

**LLR 62521** (1054436)





**A** 



**A Fileworks® 9300  
Lateral Filing Cabinets**

Fixed front drawers. Welded front corners. Snap-in recessed short pulls. Lock and suspension rods included. 36 in. wide.

- 2 drawers**
- GLB 93362F1HBL (387373) black
- GLB 93362F1HGR (474379) grey
- GLB 93362F1HNE (446013) nevada
- 3 drawers**
- GLB 93363F1HBL (387381) black
- GLB 93363F1HGR (446021) grey
- GLB 93363F1HNE (474387) nevada
- 4 drawers**
- GLB 93364F1HBL (387399) black
- GLB 93364F1HGR (629105) grey
- GLB 93364F1HNE (474395) nevada
- 5 drawers**
- GLB93365F1HBL (413765) black
- GLB 93365F1HGR (446047) grey
- GLB 93365F1HNE (629097) nevada

**B Fileworks® 9300 Plus  
Lateral Filing Cabinets**

Fixed front drawers. Welded front corners. Lock and suspension rods included. With full length recessed handles. 36 in. width.

- 2 drawers**
- GLB 9336P2F1HB (778431) black
- GLB 9336P2F1HG (497628) grey
- GLB 9336P2F1HN (778449) beige
- 3 drawers**
- GLB 9336P3F1HB (778456) black
- GLB 9336P3F1HG (497636) grey
- GLB 9336P3F1HN (778464) beige
- 4 drawers**
- GLB 9336P4F1HB (778472) black
- GLB 9336P4F1HG (497602) grey
- GLB 9336P4F1HN (778480) beige
- 5 drawers**
- GLB 9336P5F1HB (778498) black
- GLB 9336P5F1HG (497610) grey
- GLB 9336P5F1HN (778506) beige



**B** 



**C Fileworks® 9300  
Filing Cabinet Accessories**

- Filing bars (package of 2)**
- GLB FBB (236133)
- Dividers (package of 3)**
- GLB PD (413559)
- Side-to-side file bars (package of 2)**
- GLB HFB36EFC (508978)
- Adaptors for data binders (package of 2)**
- GLB EDPS/EFC (255877)



**C** 





## A Offices to Go™ MVL1900 Series Lateral Filing Cabinets

Quality and design features of high-end filing systems at an affordable price. Full pull handle for effortless opening. Limited lifetime warranty.

### 2 drawers

**GLBMVL1936P2B** (509018) black

**GLBMVL1936P2G** (509026) grey

**GLBMVL1936P2N** (509034) nevada

**GLB MVL1936005** (829696) white

### 3 drawers

**GLB 315648** (315648) black

**GLB 509042** (509042) grey

**GLB 315671** (315671) nevada

**GLBMVL1936013** (829699) white

### 4 drawers

**GLB315655** (315655) black

**GLB509059** (509059) grey

**GLB 315689** (315689) nevada

**GLB MVL1936009** (829698) white

### 5 drawers

**GLB 315663** (315663) black

**GLB 509067** (509067) grey

**GLB 315697** (315697) nevada

**GLBMVL1936011** (829697) white

• **Hanging file bars (package of 2)**

**GLB MVLFBBEGR** (509075) front to back

**GLB 509083** (509083) side to side

• **Set of 4 casters with support rails**

**GLB MVLMLKBLK** (509091)

• **Dividers (package of 3)**

**GLB MVLPD** (509109)



New colour - WHITE!

**A** Offices to Go



## B Lateral File

Core removable lock. Interlock system that allows only 1 drawer open at a time. Ball-bearing Suspension. Includes security Lock. Recessed Handle. Made steel. Letter, legal or A4 size. Contains 28% recycled content. Greenguard certified. Covered by Lorell limited lifetime warranty.

### 2 drawers

**LLR 60557** (1021237) black

**LLR 60558** (1021229) light grey

**LLR 60556** (1021211) putty

### 4 drawers

**LLR 60560** (1021253) black

**LLR 60561** (1021245) light grey

**LLR 60559** (1021492) putty

• **Front-to-back hanging file bars (package of 4)**

**LLR 60565** (1021773)

• **Dividers (box of 10)**

**LLR 60564** (1021765)



**B** LORELL

## C Fortress Serie Lateral File

All drawers above the bottom one have receding fronts and roll-out shelves. Bottom drawer has a fixed front. Letter, legal or A4 size folders. Ball-bearing Suspension. Locking Drawer. Recessed Handle. Contains 16% recycled content. Made steel. Greenguard Certified. Covered by Lorell limited lifetime warranty.

**LLR 43511** (1021179) black

**LLR 43510** (1021187) putty

**4 drawers. 42 x 19 x 52-1/2 in. H.**

**LLR 43515** (1021591) black

**LLR 43514** (1021583) putty

**5 drawers. 36 x 19 x 69 in. H.**

**LLR 43513** (1021195) black

**LLR 43512** (1021203) putty

**5 drawers. 42 x 19 x 69 in. H.**

**LLR 43517** (1021617) black

**LLR 43516** (1021609) putty



**C** LORELL



**A Lateral File**

Interlock system prohibits the extension of more than one drawer at a time for your safety. Each drawer has a magnetic label holder for easy identification where you need it. Ball-bearing Suspension. Includes security Lock. Recessed Handle. Made steel. Letter, legal or A4 size. Contains 28% recycled content. Greenguard certified. Covered by Lorell limited lifetime warranty.

**2 drawers. 36 x 19 x 28 in. H. 123 lbs.**

**LLR 60555** (1021286) black

**LLR 60448** (1021393) light grey

**LLR 60447** (1021401) putty

**LLR00037** (1021633) silver

**LLR00029** (1021625) white

**2 drawers. 42 x 19 x 28 in. H. 144 lbs.**

**LLR 60554** (1021310) black

**LLR 60439** (1021419) light grey

**LLR 60438** (1021427) putty

**3 drawers. 36 x 19 x 40 in. H. 153 lbs.**

**LLR 88028** (1021435) black

**LLR 88029** (1021443) light grey

**LLR 88027** (1021451) putty

**LLR00038** (1021659) silver

**LLR00030** (1021641) white

**3 drawers. 42 x 19 x 40 in. H. 173 lbs.**

**LLR 88031** (1021468) black

**LLR 88032** (1021476) light grey

**LLR 88030** (1021484) putty

**4 drawers. 36 x 19 x 52-1/2 in. H. 174 lbs.**

**LLR 60553** (1021294) black

**LLR 60445** (1021500) light grey

**LLR 60444** (1021518) putty

**LLR 00039** (1021674) silver

**LLR 00031** (1021666) white

**4 drawers. 42 x 19 x 52-1/2 in. H. 195 lbs.**

**LLR 60552** (1021328) black

**LLR 60436** (1021526) light grey

**LLR 60435** (1021534) putty

**5 drawers. 36 x 19 x 68 in. H. 202 lbs.**

**LLR 60551** (1021302) black

**LLR 60442** (1021542) light grey

**LLR 60441** (1021550) putty

**LLR00040** (1021690) silver

**LLR00032** (1021682) white

**5 drawers. 42 x 19 x 68 in. H. 230 lbs.**

**LLR 60550** (1021336) black

**LLR 60433** (1021567) light grey

**LLR 60432** (1021575) putty

**B Commercial Cabinet Dolly**

Ideal for lateral files or storage cabinets. It adjusts to widths of 30 in., 36 in. and 42 in. and depths of 18 in., 18-5/8 in., 19-1/4 in. and 24 in. Dolly rolls easily on heavy-duty casters with two locking for loading stability. Black metal. 42 x 24 x 4 in. H. Contains 28% total recycled content.

**LLR 59708** (1021758)



## A Fileworks® 2600 Plus Legal Size Vertical Filing Cabinet

Recessed full pulls. Full height sides, serve as supports for hanging folders. Mobile compression plate. Lock. 18" width. 26-9/16 in. depth.

**2 drawers, 29 in. H.**

**GLB 26252BLK** (686055) black

**GLB26252GRY** (509638) grey

**GLB 26252NEV** (679639) nevada

**4 drawers, 52 in. H.**

**GLB26452BLK** (679613) black

**GLB 26452GRY** (679647) grey

**GLB 26452NEV** (679621) nevada

## B MVL25 Series Letter Size Vertical File

Commercial quality. Keylock included with removable core.

Drawer fronts feature a recessed angled full pull. High side walls to accommodate hanging folders. Ball bearing suspension. Coated with environmentally friendly, recyclable paint, electrostatically applied for a durable finish. Meets or exceeds ANSI/BIFMA standards. Greenguard Certified. Lifetime warranty. 15 in. width. 25 in. depth.

**2 drawers, 29 in. H.**

**GLB MVL25201B** (509414) black

**GLB MVL25201G** (509422) grey

**GLBMVL25201N** (509430) nevada

**GLBMVL2520001** (829700) white

**4 drawers, 52 in. H.**

**GLBMVL25401B** (509471) black

**GLBMVL25401G** (509489) grey

**GLBMVL25401N** (509497) nevada

**GLB MVL2540001** (829701) white

• **Follower block**

**GLB MVLFBEGR** (509539)

## C MVL25 Series Legal Size Vertical File

Commercial quality. Keylock included with removable core.

Drawer fronts feature a recessed angled full pull. High side walls to accommodate hanging folders. Ball bearing suspension. Coated with environmentally friendly, recyclable paint, electrostatically applied for a durable finish. Meets or exceeds ANSI/BIFMA standards. Greenguard Certified. Lifetime warranty. 18-1/4 in. width. 25 in. depth.

**2 drawers, 29 in. H.**

**GLB MVL25251B** (509448) black

**GLB MVL25251G** (509455) grey

**GLB MVL25251N** (509463) nevada

**GLBMVL2525001** (829702) white

**4 drawers, 52 in. H.**

**GLB MVL25451B** (509505) black

**GLB MVL25451G** (509513) grey

**GLB MVL25451N** (509521) nevada

**GLBMVL2545002** (829703) white

• **Follower block**

**GLB MVLFBEGR** (509539)





**A Fileworks® 2600 Legal Size Vertical Filing Cabinet**

Conventional handles with security latch. Full height sides, serve as supports for hanging folders. Mobile compression plate. Lock. 18 in. width. 26-9/16 in. depth.

- 2 drawers**
- GLB 26251BLK (313064) black
- GLB 26251GRY (617506) grey
- GLB 26251NEV (414151) nevada
- 3 drawers**
- GLB 26351BLK (313072) black
- GLB 26351GRY (617498) grey
- GLB 26351NEV (414169) nevada
- 4 drawers**
- GLB 26451BLK (313080) black
- GLB 26451GRY (617480) grey
- GLB 26451NEV (414177) nevada

New colour - WHITE!



**B MVL Pedestal**

Includes side-to-side conversion bar for legal filing. Legal size. Locks included. 15 x 23 x 27 in. H.

- 2 drawers**
- GLB189233 (189233) black
- GLB189241 (189241) grey
- GLB 189258 (189258) nevada
- GLBMVLW23F002 (829704) white
- 3 drawers**
- GLB189209 (189209) black
- GLB189217 (189217) grey
- GLB189225 (189225) nevada
- GLBMVLW23B003 (829705) white

**C Mobile Pedestal File**

Features 2 filing drawers. Ball-bearing suspension. Includes security lock. Recessed handle. Made steel. Letter size. Contains 28% recycled content. Covered by Lorell limited lifetime warranty.

- 2 drawers - letter size - 15 x 20 x 27-3/4 in.**
- LLR49524 (1020866) black
- LLR49525 (1020874) light gray
- LLR49523 (1020882) putty
- LLR00053 (1021021) silver
- LLR00050 (1021013) white
- 2 drawers - legal size - 15 x 23 x 27-3/4 in.**
- LLR49530 (1020924) black
- LLR49529 (1020940) putty
- 3 drawers - letter size - 15 x 20 x 27-3/4 in.**
- LLR49521 (1020833) black
- LLR49531 (1020932) light grey
- LLR49522 (1020841) light gray
- LLR49520 (1020859) putty
- LLR00052 (1021005) silver
- LLR00049 (1020999) white
- 3 drawers - legal size - 15 x 23 x 27-3/4 in.**
- LLR49527 (1020890) black
- LLR49528 (1020908) light grey
- LLR49526 (1020916) putty



## A Commercial Grade Vertical File

Steel ball-bearing suspension provides smooth and quiet drawer performance. Heavy gauge steel. Factory installed core removable lock. Adjustable wire followers keeps files upright. Greenguard gold certified. Meets or exceeds ANSI/BIFMA industry standard. Limited lifetime warranty. 28% recycled content, 16% post-consumer.

**Letter size. 2 drawers. 28-1/8 in. H.**

LLR 42291 (1020536) black

LLR 42292 (1020544) light grey

LLR42290 (1020552) putty

**Letter size. 4 drawers. 52 in. H.**

LLR 42294 (1020569) black

LLR 42295 (1020577) light grey

LLR 42293 (1020585) putty

**Legal size. 2 drawers. 28-1/8 in. H.**

LLR 54859 (1020775) black

LLR 54860 (1020783) light grey

LLR 54858 (1020791) putty

**Legal size. 4 drawers. 52 in. H.**

LLR 54862 (1020809) black

LLR 54863 (1020817) light grey

LLR 54861 (1020825) putty



## B Large Capacity Commercial Grade Vertical File

Steel ball-bearing suspension provides smooth and quiet drawer performance. Heavy gauge steel. Factory installed core removable lock. Adjustable wire followers keeps files upright. 26-1/2 in. deep. Greenguard gold certified. Meets or exceeds ANSI/BIFMA industry. Limited lifetime warranty. 28% recycled content, 16% post-consumer.

**Letter size. 2 drawers. 28-3/8 in. H.**

LLR 60194 (1020478) black

LLR 60195 (1020486) light grey

LLR 60196 (1020494) putty

**Letter size. 4 drawers. 52 in. H.**

LLR 60191 (1020502) black

LLR 60192 (1020510) light grey

LLR 60193 (1020528) putty

**Letter size. 5 drawers. 61-3/8 in. H.**

LLR 48498 (1020627) black

LLR 48499 (1020635) light grey

LLR 48497 (1020643) putty

**Legal size. 2 drawers. 28-3/8 in. H.**

LLR 60661 (1020411) black

LLR 60662 (1020429) light grey

LLR 60660 (1020437) putty

**Legal size. 4 drawers. 52 in. H.**

LLR 60198 (1020445) black

LLR 60199 (1020453) light grey

LLR 60197 (1020460) putty

**Legal size. 5 drawers. 61-3/8 in. H.**

LLR 48501 (1020593) black

LLR 48502 (1020601) light grey

LLR 48500 (1020619) putty



## C 3-Drawer Vertical File

The lock secures the two top drawers. Assembly Required.

Letter size. Black steel. Covered by Lorell limited lifetime warranty. 14 x 18 x 35.5 in. H. Black. 28% recycled content, 16% post-consumer.

LLR 18573 (1021047)

## D Commercial Grade File Caddy

For any vertical cabinet file. Adjusts to fit letter or legal size.

For cabinets of 18 to 26-1/4 in deep and 14-1/4 to 28 in. wide. 11-3/8 x 16-5/8 x 4 H. Black. 28% recycled content, 16% post-consumer.

LLR 17573 (1020354)





**A Multi-Stor Storage/Filing Cabinet**

Combination storage cabinet with 3 shelves, One of which is adjustable and lateral filing cabinet with 2 fixed front drawer. 2 locks. 36 x 18 x 65-1/4 in. H.  
**GLB 422980** (422980) black  
**GLB 478503** (478503) grey  
**GLB 696104** (696104) nevada

**B Fileworks Storage Cabinet**

1 fixed shelf, 3 adjustable shelves. 36 x 18 x 72 in. H. Lock.  
**GLB 617514** (617514) black  
**GLB 475897** (475897) grey  
**GLB 617472** (617472) nevada

**C Storage Cabinet**

1 central fixed shelf, 1 adjustable shelf. 36 x 18 x 42 in. H.  
**GLB 629238** (629238) black  
**GLB 629246** (629246) grey  
**GLB 481127** (481127) nevada

**D Additional Shelf for 9300/9300P Storage Cabinet**

36 x 18 in.  
**GLB 9336FWSBL** (509356) black  
**GLB 9336FWSGR** (509364) grey  
**GLB 9336FWSNE** (509372) nevada



## A MVL Storage Cabinet

Four shelves, 1 fixed and 3 adjustable. Door front features a recessed angled full pull. Removable core cam lock and levelling glides included. Bottom pan can be used as a shelf. Meets or exceeds ANSI/BIFMA standards. 36 x 18 x 72 in. H.

**GLBMVLS72LBLK** (509380) black  
**GLB MVLS72LGRY** (509398) grey  
**GLB MVLS72LNEV** (509406) nevada  
**GLBMVLS72LDWT** (829706) white

New colour - WHITE!



## B Lateral Files Combo Unit

Features a lateral file, bookcase and printer stand. The top shelf adjusts 8 in. Two knockouts in back panel offer easy cable management. Ball-bearing suspension. Includes security lock. Recessed handle. Made steel. Letter, legal or A4 size. Black. 36 x 19 x 60 in. H. Greenguard certified. Covered by Lorell limited lifetime warranty. 28% recycled content, 16% post-consumer.

**2 storage and 1 filing drawer**  
**LLR66205** (1021344)  
**2 filing drawers**  
**LLR 66206** (1021352)

## C Lateral File With Box Drawer

Includes a personal storage compartment, two box drawers and a file drawer. Ball-bearing suspension. Includes security lock. Recessed handle. Made steel. Letter, legal or A4 size. Greenguard certified. Covered by Lorell limited lifetime warranty. Black. 30 x 19 x 28 in. H. 28% recycled content, 16% post-consumer.

**LLR 60933** (1021260)

**A** **OfficestoGo**



## D Lateral File Cabinet

Includes 3 versatile drawers. Ball-bearing slide suspension. Letter, legal or A4 size. Black. 36 x 19 28 in. H. Greenguard Gold certified. Covered by Lorell limited lifetime warranty. 28% recycled content, 16% post-consumer.

**LLR 60929** (1021278)

## E Locker

Strong, one piece design boasts a heavy gauge all steel construction so it can stand up to tough conditions in any environment. Units can be used as stand alone or can be linked together. Two-tone finish. 12 x 18 x 78 in. H.

**Single tier locker**  
**SAF 5522GR** (320606) grey  
**SAF 5522TN** (320655) tan

**Double tier locker**  
**SAF 5523GR** (320614) grey  
**SAF5523TN** (320663) tan

**Six tier locker**  
**SAF 5524GR** (320622) grey  
**SAF 5524TN** (320671) tan



**B** **LORELL**



**C** **LORELL**



Find Padlocks  
 on **pages 562-563**



**D** **LORELL**



**E** **SAFCO**



**A**  **SAFCO**



**A Industrial Metal Shelving**

Made of strong, welded wire construction. Includes 4 posts and snap-together clips, no tools required. 4 adjustable shelves. Open-wire design allows air circulation and prevents dust accumulation. Black powder coat finish.

- Complete unit**  
**SAF 5285BL** (112250) 36 x 18 x 72 in. H.  
**SAF 5294BL** (112243) 48 x 24 x 72 in. H.  
**Add-on kit - 2 posts and 4 shelves**  
**SAF 5286BL** (112268) 36 x 18 x 72 in. H.  
**SAF 5295BL** (112276) 48 x 24 x 72 in. H.

**B Wire Deck Shelving**

Features a boltless design. Total capacity of 2,300 lb. Easy-to-clean shelves are supported by a heavy-duty steel frame with a rust-resistant, powder-coat finish. Assembles vertically or horizontally. Wire mesh shelves. Black. Covered by Lorell limited lifetime warranty.

- 4 shelves**  
**LLR 99928** (1022318) 36 x 18 x 60 in. H.  
**5 shelves**  
**LLR 99929** (1022326) 36 x 18 x 72 in. H.  
**LLR 99930** (1022334) 48 x 18 x 72 in. H.



**B**  **LORELL**

**C Boltless Shelving**

Unique construction requires no nuts or bolts and assembles in minutes without tools. Steel construction with durable black powder coat finish. 5 shelves. Black.

- SAF 5245BL** (338103) 36 x 18 x 72 in. H.  
**SAF 5246BL** (320515) 48 x 18 x 72 in. H.

**D Riveted Steel Shelving**

Offers a boltless design for simple assembly. It holds up to 3,200 lb of evenly distributed weight on its black laminate shelving. Black laminate shelves included. Shelving assembles vertically or horizontally. Grey colour. Contains 30% recycled content. Covered by Lorell limited lifetime warranty.

- 4 shelves**  
**LLR 59700** (1022227) 36 x 18 x 60 in. H.  
**5 shelves**  
**LLR 59701** (1022235) 36 x 18 x 72 in. H.  
**LLR 59702** (1022243) 48 x 18 x 72 in. H.  
**LLR 59703** (1022251) 48 x 24 x 72 in. H.



**C**  **SAFCO**



**E Riveted Steel Shelving**

Capacity of 3,800 lb of evenly distributed weight with its heavy-duty, riveted steel construction. Boltless design assembles with rubber mallet in less than 30 minutes. Assembles vertically or horizontally. Tough powder coat finish. Black. 5 shelves. Contains 30% recycled content. Covered by Lorell limited lifetime warranty.

- LLR 61621** (1022276) 36 x 18 x 72 in. H.  
**LLR 61622** (1022284) 48 x 18 x 72 in. H.  
**LLR 60624** (1022292) 48 x 24 x 72 in. H.  
**LLR 60648** (1022300) 48 x 24 x 84 in. H.

Find Bookcases on **page 175**



**D**  **LORELL**



**E**  **LORELL**





## A Fireproof Lateral File

UL 1-Hour Fire & Impact Rated. ETL 1/2hr Media. Medeco High Security Key Lock. Chrome Handles. Limited lifetime warranty. Free replacement after fire guarantee. Letter and legal size. 31-3/16 in. width. 22-1/8 in. depth. Parchment

**2 drawers. 27-3/4 in. H.**  
**FIR 2-3122-CPA** (504852)  
**4 drawers. 52-3/4 in. H.**  
**FIR 4-3122-CPA** (504860)



## B Turtle Vertical Filing Cabinet

Perfect for your home, personal office or small business. UL 1-hour fire protection with impact rating. Standard 4-pin key lock. Limited lifetime warranty. Free replacement after fire guarantee. Letter or legal size. 17-3/4 in. width. 22-1/8 in. depth. Parchment.

**2 drawers. 27-3/4 in. H.**  
**FIR 2R1822CPA** (504910)  
**4 drawers. 52-3/4 in. H.**  
**FIR 4R1822CPA** (504928)



## C Classique 25 Fire Resistant File

U.L.I. certified 1 hour at 350°F (177°C). Lock. Adjustable suspension bars for letter or legal size documents. Putty. Interior dimensions: 10-1/2 x 15 x 20 in. H. Outside dimensions: 19-3/4 x 25 x 54 in. H. Outside dimensions: 19-3/4 x 25 x 28 in. H.

**2 drawers (380 lb)**  
**GDX GF-25-2-PU** (204362)  
**4 drawers (650 lb)**  
**GDX GF-25-4-PU** (204370)

## D Fire Safe Lateral File

U.L.I. classified. 1 hour at 350°F (177°C). Lock and suspension bars included. Legal size. Putty. Ext.: 38-3/4 x 23-1/2 in.

**2 drawers - 29 in. H.**  
**GDX GL-402-PU** (156448)  
**4 drawers - 55 in. H.**  
**GDX GL-404-PU** (156422)



## E Fireproof Storage Cabinet

For oversized documents, binders, storage boxes and end-tab filing. UL 1-Hour Class 350 Fire Rating. Oven-dried Gypsum Insulation. Field-Replaceable Steel Panels. Exterior Mounted Handles. High-Security UL listed Medeco® Lock. Made in the USA. Lifetime Limited Warranty. Free replacement after fire guarantee. 19-1/4 in. depth. 620 lb.

**36 x 44 in.**  
**FIR CF4436DAW** (505024) white  
**FIR CF4436-DPA** (505032) parchment  
**36 x 72 in.**  
**FIR CF7236DAW** (505065) white  
**FIR CF7236-DPA** (505073) parchment





**A** **SentrySafe**



**B** **SentrySafe**



**A Portable Security Safe**

Steel construction. Battery-powered digital locking system. Carrying handle. Interior: 12 x 8.9 x 4.3"H. Exterior: 13 x 10 x 4.4"H. **SEN P021E** (572644)

**B 1200 Fire Chest**

0.18 cu. ft. (5 liters). New contoured body design. UL classified for fire endurance for 1/2 hour at 843°C. Key lock. Carrying handle. Ext.: 11.2 x 14.3 x 6.1 in. H. Int.: 7.5 x 12 x 3.5 in. H. Black. **SEN 1200** (188706)

**C CHW20201 Waterproof / Fire-Resistant Chest**

UL classified. Resists 1/2 hour at 1550°F. (843°C). Water-resistant. ETL verified for water submersion up to 72 hours. Tubular key locking mechanism. Holds letter size documents. Int.: 8.5 x 12.8 x 4.4 in. H. Ext.: 14.3 x 15.4 x 6.6 in. H. **SEN CHW20201** (279554)



**C** **SentrySafe**



**D** **SentrySafe**



**D Security Fire File**

Holds letter size hanging files. Privacy key lock with two keys. UL classified fire protection 30 minutes at 1500 degrees Fahrenheit. ETL verified for fire protection of digital media 30 minutes. Black. 0.61 cu.ft. Int: 12 x 8.5 x 10.4 in. H. Ext: 15.3 x 12.1 x 13.6 in. H. **SEN 1170BLK** (1024066)

**E PL048E Electronic Security Safe**

Perfect for on-the-go security. Programmable electronic lock with override key. Automatic delay after multiple incorrect attempts. Steel tethering cable provides added theft deterrence. Steel construction. Requires 4 AA batteries. 0.5 cu. ft. Int.: 16.4 x 11.3 x 3.6 in. H. Ext.: 17.5 x 13.6 x 5.8 in. H. Black. **SEN PL048E** (163022)

**F Under Counter Drop Slot Safe**

Underdesk installation. Protects cash, receipts, deposit slips, keys, etc. Anti-fish slot. Dual key lock. Piano hinge. UC-25, 25 cu. ft.: int.: 5.8 x 10.5 x 6.5 in. H. Powder coat finish. Grey. **SEN UC025K** (115808)



**E** **SentrySafe**



**F** **SentrySafe**

**G Depository Safe**

Programmable electronic lock with time delay. Solid steel construction. Anti-drill door with relocking device. Anti-fish hopper. Three live locking bolts. Bolt down with pre-drilled holes. Black. 0.94 cu. ft. Int: 13.7 x 11.3 x 10.5 in. H. Ext: 14 x 15.6 x 20 in. H. **SEN DH074E** (1024009)



**G** **SentrySafe**

**A HL100ES Electronic Security Safe**

Steel. 11 cubic feet. Choose between re-programmable electronic lock key or card swipe reader. Master override key allows for backup access. Battery jump unit. 2 live locking. Fits up to 17 in. laptops. Interior LED light. Carpeted floor. Int.: 17.8 x 8.5 x 12.4 in. H. Bolt-down hardware included. Black.

**SEN HL100ESB** (279570)



**A** SentrySafe



**B** SentrySafe



**B X055 Electronic Security Safe**

Steel. 0.5 cubic feet. Electronic lock with override key. Carpeted floor. Int.: 13-5/8 x 8-5/8 x 8-1/2 in. H. Bolt-down hardware included. Black.

**SEN X055** (768184)

**C X125 Electronic Security Safe**

Steel. 1.2 cubic feet. Electronic lock with override key. Removable shelf. Fits most laptops. Access for power cord. Carpeted floor. Int.: 16-3/4 x 12-5/8 x 10-1/2 in. H. Bolt-down hardware included. Black.

**SEN X125** (768192)

**D Large Combination Fire/Water Safe**

UL classified fire protection. ETL verified protection in up to 5 in. off water for 24 hours. Dual mechanical dial and key lock. Multi-position tray. Digital media protection. Three one in. live locking bolts. Black. 8 cu.ft. Int: 12.6 x 11.5 x 9.6 in. H. Ext: 16.3 x 19.3 x 13.7 in. H.

**SEN SFW082DTB** (1023993)



**C** SentrySafe



**D** SentrySafe



**E XX-Large Combination Fire Safe**

Dual combination lock and key. Flexible file organizer and tray for important records. Door pocket, key rack and compartment for small items. 6 large 1 in. bolts - 60% bigger than traditional safes. UL Classified for Fire Endurance (1-hour at 1700°F/927°C). ETL Verified to withstand a 15-foot/4.5-meter drop. ETL Verified for 1-hour fire protection for digital media up to 1700°F/927°C. ETL Verified water protection up to 8 in. for 24 hours. May be bolted down (hardware included). Exterior: 18.6 x 19.3 x 23.8 in. H.

**SEN SFW205DPB** (511998)

**F Executive Fire-Safe®**

ETL Verified for Fire Endurance of 30 minutes at 1400°F. ETL Verified water resistant for 12 in. of water for 72 hours. Programmable electronic lock with override key. 7 oversized bolts with thicker door. Bolt down kit included. 2 multi-position shelves. Carpeted interior. 3.4 Cu.Ft. Exterior: 21.69 x 19 x 27.75 po. H.

**SEN EF3428E** (511980)



**E** SentrySafe



**F** SentrySafe



**G Grand Prix Fire Resistant Safe**

ULI listed, 1 hour at 350°F (177°C). Sargent & Greenleaf® combination lock. Beige.

**1 adjustable shelf. Int. : 15-1/2 x 12-1/2 x 17-1/2**  
**GDX GX-1-BEIGE** (156489) 175 lb

**1 adjustable shelf. Int. : 18-1/8 x 15-3/8 x 22-3/8"H.**  
**GDX GX-2-BEIGE** (156497) 250 lb

**2 adjustable shelves. Int. : 23-1/2 x 20-3/8 x 32-1/4"H.**  
**With casters.**

**GDX GX-3-BEIGE** (156372) 455 lb

**3 adjustable shelves. Int. : 23-1/2 x 20-3/8 x 42-1/4"H.**  
**With casters.**

**GDX GX-4-BEIGE** (413799) 575 lb



**G** GARDEX



**EXPRESS**  
14-28  
years/days

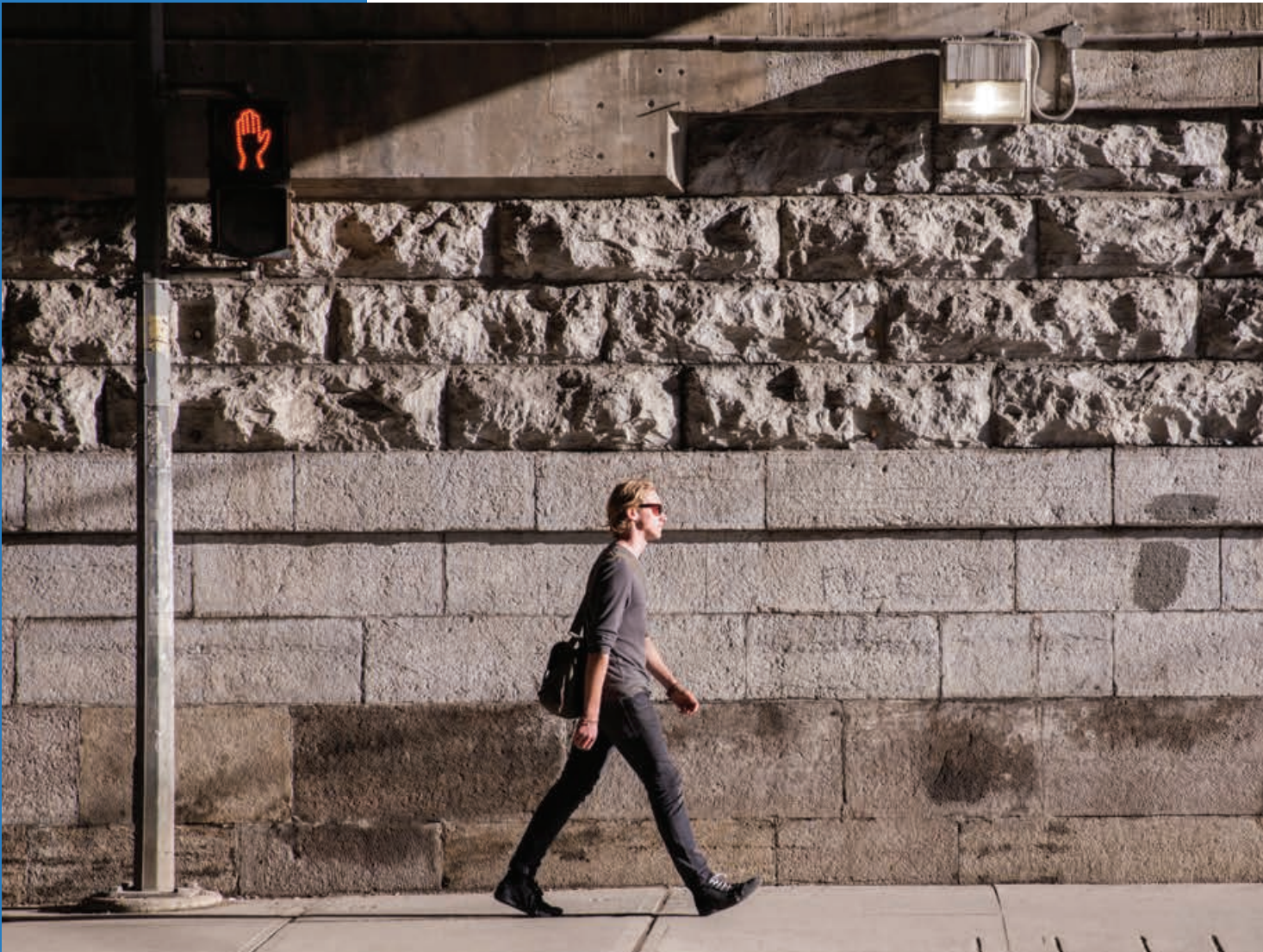

# Individuality

Workers want to inject their personality into their spaces. In this section you will find all the office tools to enhance each worker's individual task with a little bit of style.

# WORKPLACE TOOLS AND ACCESSORIES

## HYBRID WORK AND TRAVEL ACCESSORIES

Writing Cases .....	<b>220</b>
Business Backpacks .....	<b>221</b>
Business Briefcases .....	<b>224</b>
Travel Accessories .....	<b>228</b>
Fashion Business Cases .....	<b>230</b>

## DESK AND WORKSTATION ACCESSORIES

Desktop Organizers .....	<b>232</b>
Sorters .....	<b>242</b>
Desk Pads .....	<b>246</b>
Cubicle Panel Accessories .....	<b>248</b>
Wall Files .....	<b>250</b>
Lighting .....	<b>252</b>
Clocks .....	<b>255</b>

## BOARDS AND EASELS

Glass Boards and Accessories .....	<b>257</b>
Dry Erase Boards and Accessories .....	<b>259</b>
Chalkboards and Accessories .....	<b>265</b>
Bulletin Boards and Accessories .....	<b>266</b>
Easel and Conference Pads .....	<b>269</b>

## RETAIL, BUSINESS AND EVENT SUPPLIES

Literature Holders and Racks .....	<b>271</b>
Signs .....	<b>274</b>
Sign Holders, and Nameplates .....	<b>277</b>
ID Badges and Accessories .....	<b>281</b>
Entrance/Reception Supplies .....	<b>285</b>
Price/Label Guns and Accessories .....	<b>286</b>





**A** bugatti



**B** bugatti

**A WRC1503 Writing Case**

Vegan leather. Zip around closure. Inside document pocket. ID window. Two USB drive holders. Letter size writing pad included. 10 x 13-1/4 in. Black.  
**BUG323832** (323832)

**B WRC1512 Ring Binder Writing Case**

Vegan leather. Zip around closure. Front pocket for a quick access. Padded section for a 13 in. tablet. ID window. Two USB drive holders. Letter size writing pad included. 10 x 13 in. Black.  
**BUGWRC1512BLK** (376509)

**C WRC1511 Writing Case**

Vegan leather. Slot who can hold a tablet up to 13 in. ID window. One pen holder. Letter size writing pad included. 10 x 12-1/2 in. Black.  
**BUG 829873** (829873)

**D WRC5195 Writing Case**

Vegan leather. Pressure button closure. Padded section fits most 11 in. tablets. One inside pocket. Four pen/USB drive loops. 4 card slots. Letter size writing pad included. 12-3/4 x 13 in. Pink.  
**BUG 829876** (829876)



**C** bugatti



**D** bugatti



**E WRC5096 Writing Case**

Vegan leather. Zip around closure. Front pocket for a quick access. Features an adjustable tablet holder (up to 11 in.) and one pen holder. Letter size writing pad included. 10-1/2 x 13 in. Black.  
**BUG 829875** (829875)

**F WRC5043 Writing Case**

Vegan leather. Zip around closure. Section fits most 11 in. tablets. Calculator included. ID window. 4 card slots. 1 pen holder. 10 x 13-1/4 in. Brown.  
**BUG 829874** (829874)



**E** bugatti



**F** bugatti



**G RGB2391 Ring Binder Writing Case**

Textured vegan leather. Zip around closure. Padded tablet section fits most 13 in. tablets. One pen holder and one calculator included. ID Window. 4 card slots. Letter size writing pad included. 10 x 13-1/2 in. Black.  
**BUG 829868** (829868)

**H RGB1107 Ring Binder Writing Case**

Vegan leather. Zip around closure. Padded tablet section fits most 14 in. tablets. Inside document pocket. 2 pen holders. External handle. Legal size writing pad included. 13 x 15-1/4 in. Black.  
**BUG 515304** (515304)

**I RGB1105 Ring Binder Writing Case**

Vegan leather. Front open pocket for quick access. Zip around closure. 1 in. round-ring binder, card slots, I.D. window and pen holder. Inside document pocket. Letter size writing pad included. 13-1/2 x 11 in. Black.  
**BUG375394** (375394)



**G** bugatti



**H** bugatti

Legal size



**I** bugatti

## A BKP106 Business Backpack

Polyester. Up to 15.6 in. fully padded and secured laptop compartment. Multiple storage sections. Front zippered pocket for business accessories including tablet and quick access. Dual lateral expandable mesh pockets. Fully padded and ventilated mesh back. Adjustable padded shoulder straps. Carry handle. 11-3/4 x 7-1/4 x 16-3/4 in. H. Black. **BUG 378760** (378760)



**A** bugatti



**B** bugatti



## B BKP120 Business Backpack

Polyester. Up to 15.6 in. fully padded computer compartment. Multiple storage sections. Adjustable padded shoulder straps. Dual lateral pockets. Carry handle. Front zippered pockets for easy access. 11 x 7-1/4 x 18 in. H. Navy blue. **BUGBKP120NAVY** (515429)

## C BKP2267 Business Backpack

Rubberized vegan leather. Padded shoulder straps and back for extra comfort. One main compartment. Inside padded laptop up to 15.6 in. sleeve. Front adjustable buckle & drawstring for the main compartment. 12 x 6 x 18 in. H.

**BUG 829849** (829849) khaki

**BUG 829848** (829848) blue

**BUG 829850** (829850) sand



**C** bugatti

## D BKP110 Business Backpack

Polyester. Up to 17.3 in. fully padded laptop compartment. Multiple storage sections. Front zippered pocket for business accessories and quick access. Dual lateral pockets. Adjustable padded shoulder straps. Integrated Identity Block™ protection. Carry handle. 12 x 9 x 19 in. H. Black.

**BUG378273** (378273)



**D** bugatti



## E BKP113 Business Backpack

Polyester. Large size fits laptop up to 17.3 in. Large main compartment. Two side pockets. Organizer pocket. Tablet section. Soft padded back and shoulder straps. Solid metal top handle. 17-3/4 x 8-1/4 x 13 in. H. Black and grey.

**BUG379057** (379057)

## F BKP116 Business Backpack

Vegan leather. Up to 15.6 in. fully padded computer compartment. Padded back and shoulder strap. Integrated Identity Block™ protection. Dual lateral pockets. Carry handle. Front zippered pocket. 12 x 7 x 16.5 in. H.

**BUG515312** (515312) black

**BUG515320** (515320) cognac



**E** bugatti



**F** bugatti



## G BKP2428 Business Backpack

Polyester. Up to 15.6 in. fully padded laptop compartment. Large main compartment. Two front zippered pockets and two mesh side pockets. Adjustable, padded shoulder straps. 12.5 x 7.5 x 19 in. H.

**BUG 829851** (829851) black

**BUG 829852** (829852) khaki

## H BKP2159 Business Backpack

Nylon with vegan leather accents. Up to 15.6 in padded laptop compartment. Multiple interior organizational pockets. Interior pocket with RFID protection. Side pockets and water bottle compartment. Trolley pass-through. 2-1/2 x 5 x 16-1/4 in. H. Black.

**BUG805243** (805243)



**G** bugatti



**H** bugatti



**i** All Bugatti products can be personalized. Contact us for more information.

bugatti  
REBARN



**MADE FROM 100% RECYCLED BOTTLES**

*Helping the planet, one bottle at a time*



plastic  
bottles

converted  
to beads

transformed  
to thread

making  
of bags

water  
repellent  
too!



bugatti  
REBORN



All products are available in these 3 colours.

## A Reborn 2-in-1 Tote Bag

Polyester. Large main compartment with padded 15 in. laptop section. Retractable and padded rear shoulder straps. Several exterior pockets with organizer section. Interior elastic bottle holder. Integrated key ring. RFID protection. 5 x 14 x 16 in.

**BUG823686** (823686) black

**BUG829864** (829864) navy

**BUG823687** (823687) grey



## B Reborn Backpack

Polyester. Large main compartment. Padded section for laptop up to 14 in. Padded straps. Elastic bottle holder. Front compartment with key ring. Several exterior pockets with organizer section. Hidden back pocket. Internal tablet pocket. Rear strap to attach the bag to your suitcase. RFID protection. 5 x 14 x 16 in.

**BUG823731** (823731) black

**BUG823733** (823733) navy

**BUG823732** (823732) grey

## C Reborn Convertible Crossbody Bag

Polyester. Long adjustable shoulder strap. Zippered back pocket. Hidden front pocket. Snap closure for quick access. Internal pocket for tablet up to 11 in. Integrated key ring. RFID protection to secure your personal information. Large pocket under the front flap with magnetic closure. 2 x 11 x 12.2 in.

**BUG823720** (823720) black

**BUG823722** (823722) navy

**BUG823721** (823721) grey

A



B



## D Reborn Tote Bag

Polyester. Interior padded section that can fit a 14 in. laptop. Multiple interior pockets with organizer sections. Reinforced top carry handles. Trolley sleeve to easily slide the bag over your suitcase. RFID protection to keep your personal information secure. 18 x 7 x 13 in.

**BUG823685** (823685) black

**BUG829863** (829863) navy

**BUG829862** (829862) grey

C



D



## E Reborn Convertible Travel Bag

Polyester. Interior zippered pocket. Waterproof pocket with vertical zipper to keep your belongings dry. Integrated key ring. Adjustable and removable padded shoulder straps to go from backpack to travel bag. Drawstring shoe bag included. RFID protection to secure your personal information. 18 x 11 x 11 in.

**BUG823734** (823734) black

**BUG823736** (823736) navy

**BUG823735** (823735) grey

## F Reborn Slim Crossbody Bag

Polyester. Long adjustable shoulder strap. Front and back pocket for easy access. Interior padded section for your tablet up to 11 in. RFID protection to keep your personal information secure. 9 x 4 x 14 in.

**BUG829853** (829853) black

**BUG829855** (829855) navy

**BUG829854** (829854) grey

E



F





**A** b u g a t t i

15.6"



**B** b u g a t t i

17.3"

**A EXB529 Slim Briefcase**

2-tone polyester. Padded compartment for laptop up to 15.6 in. One front zippered pocket. Adjustable and removable shoulder strap. 15-1/2 x 1-3/4 x 11-1/2 in. H. Black and grey.  
**BUG378216** (378216)

**B EXB530 Briefcase**

Polyester. Compartment for laptop up to 17.3 in. Two main zippered compartments. Front pockets. Tablet sleeve. Removable shoulder strap. Carry handles. 17 x 5-1/2 x 12-3/4 in. H. Black and grey.  
**BUG378224** (378224)

**C EXB531 Briefcase**

Polyester. Flap over cover with buckle closure. Padded compartment protects laptop up to 15.6 in. Expandable compartment with zippered organizer section for your files. 16-1/2 x 4-3/4 x 12 in. H. Black.  
**BUG378232** (378232)

**D EXB509 Briefcase**

Polyester with vegan leather trim. Front zippered pocket with built-in organizer. Back zippered pocket with hidden trolley pass-through. Reinforced comfortable carry handles. Adjustable and removable shoulder strap. Compartment for 15.6 in. laptop. Expandable 2 in. 16-1/2 x 5-1/2 x 13 in. Black.  
**BUGEXB509-BK** (349845)



**C** b u g a t t i

15.6"



**D** b u g a t t i

15.6"

**E EXB2157 Briefcase**

Nylon with vegan leather accents. Up to 15.6 in padded laptop compartment. Interior pocket with RFID protection. Zippered exterior pocket for quick access. Reinforced handles. Adjustable and removable shoulder strap. 16-1/4 x 4 x 13-1/2 in.  
**BUG805227** (805227) black  
**BUG805235** (805235) khaki

**F EXB2020 Briefcase**

Vegan leather. Padded compartment fits up to 15.6 in laptop. Zippered closure. Multi-use built-in organizer. Front zippered pocket. Reinforced handles. Trolley pass-through. 16 x 2-3/4 x 10-1/2 in. Black.  
**BUG805276** (805276)

**G EXB501 Briefcase / Backpack**

Polyester. Can also be used as a backpack. Up to 15.6 in. padded laptop compartment. Dedicated padded tablet pocket. Front panel equipped with padded organizer. Hidden back zippered pocket. Adjustable and removable ergonomic padded tangle-free shoulder strap and/or adjustable padded shoulder straps for backpack option. Trolley pass-through. 15-3/4 x 4-1/4 x 12-1/4 in. H. Black.  
**BUG378257** (378257)



**E** b u g a t t i



15.6"



**F** b u g a t t i

15.6"



**G** b u g a t t i

15.6"

## A EXB502 Briefcase

Polyester with vegan leather accents. Up to 15.6 in. secured laptop compartment. Complete zippered front compartment with organizer. Front pocket with magnetic closure. Trolley pass-through. Padded carry handles. Removable and adjustable shoulder strap. 12 x 16 x 3.25 in. H. Black.

**BUGEXB502** (279034)



**A** bugatti



**B** bugatti



## B EXB1707 Briefcase

Polyester with vegan leather trim. Up to 17.3 in. padded laptop compartment. Two gusset briefcase with file dividers and mesh pockets. Front and back zippered pocket for quick access. Trolley pass-through. Removable and adjustable shoulder strap. 18 x 8 x 13 in. H. Black.

**BUGEXB1707** (378265)

## C EXB2436 Briefcase

Vegan leather. Large main compartment with two-way zipper. Integrated organizer panel. Interior pocket for electronic accessories. Padded compartment for 15.6 in. laptop. Adjustable and removable strap. Two reinforced handles. 17-1/4 x 5-1/2 x 13 in.

**BUG 829857** (829857) black

**BUG 829858** (829858) brown



**C** bugatti



**D** bugatti



## D MSG2505 Messenger Bag

Vegan leather. Flap with dual snap closure. Up to 15.6 in. padded laptop section. Adjustable crossbody strap. 15 x 3 x 11 in.

**BUG 829865** (829865) black

**BUG 829867** (829867) navy

**BUG 829866** (829866) grey

## E EXB5714 Briefcase

Vegan leather. Front zippered pocket with built-in organizer. Inside divider panel for more organization. Back zippered pocket with hidden trolley pass-through. Reinforced comfortable top carry handles. Adjustable and removable shoulder strap. Padded compartment fits most 15.6 in. laptops. 16-3/4 x 5-1/2 x 11-1/2 in. Black.

**BUG 829859** (829859)

## F EXB532 Briefcase

Vegan leather. Up to 15.6 in. fully padded computer compartment. Front zippered pocket. Integrated Identity Block™ protection. Adjustable shoulder straps. 16.5 x 5 x 12.5 in. H.

**BUG515353** (515353) black

**BUG515361** (515361) cognac

## G ATC2030 Expandable Attaché Case

Simulated leather. 4 to 5 in. expansion. Up to 15.6 in. padded laptop section. Integrated organizer panel. Combination locks. 17.5 x 4.5 x 13 in. H. Black.

**BUG ATC2030-BK** (740548)

## H ATC0103 Aluminum Attaché Case

Gun metal finish with aluminum accents. Up to 17.3 in. padded laptop section. Interior cushioned with poly foam and adjustable file dividers and tablet compartment. Complete organizer. Combination locks. 18 x 5 x 13 in. H. Black.

**BUGATC0103** (282285)



**E** bugatti



**F** bugatti



All Bugatti products can be personalized. Contact us for more information.



**G** bugatti



**H** bugatti



bugatti



*Designed to enhance your everyday.*



## EXECUTIVE COLLECTION Business cases on wheels

- A** BND456110-BK (BZCW456110) Black
- B** BUG377747 (BZCW053) Black
- C** BUGBZCW1645 (BZCW1645) Black

## A BKPW2620 Business Backpack

Polyester garnished with synthetic leather. In-line wheels. Up to 15.6 in. padded laptop compartment. Overnight section. Front zippered pocket for quick access. Adjustable padded shoulder straps and telescopic handle. Lateral zippered pockets. 15 x 9 x 18 in. Black.

**BUGBKPW2620** (282293)



**A** b u g a t t i



## B BZCW301 Business Case on Wheels

2-tone polyester. Padded compartment protects laptop up to 17.3 in. Secure section for overnight clothing. Double front organizer pockets. Large divider section. Button release locking telescopic handle. Protected corner wheels. Carry handle. 17-1/4 x 8-1/4 x 13-1/2 in. H. Black.

**BUG378703** (378703)



**B** b u g a t t i



## C BZCW0704 Business Case on Wheels

Vegan leather. In-line wheels with frontal stabilizing feet. Up to 17.3 in. padded computer section. Hard shell case with file dividers. Front zippered and lock flap compartment with organizer. Flap over closure with combination locks. Lateral quick access pocket. Telescopic handle. 19 x 9 x 15 in. H. Black.

**BUG BZCW0704** (282319)

## D BZCW456110 Business Case on Wheels

Vegan leather. Up to 17 in. laptop compartment. Lateral storage pockets and one front pocket. Retractable telescopic handle. Combination lock and key for the front compartment. 18-3/4 x 9 x 15-1/4 in. H. Black.

**BND456110-BK** (601823)



**C** b u g a t t i



## E BZCW053 Business Case on Wheels

Vegan leather. Up to 15.6 in. padded computer section. Dual front zippered compartments including organizer and mesh pocket. Top over closure with combination locks. Dual lateral pockets for quick access. Sturdy carry handles and a telescopic handle. In-line wheels with frontal stabilizing feet. 18 x 9 x 15.5 in. H. Black.

**BUG377747** (377747)

## F BZCW1645 Business Case on Wheels

Polyester. In-line wheels with frontal stabilizing feet. Up to 17.3 in. secured and padded computer section. Oversized hard shell case. Front main zippered around compartment with organizer. Hidden front zippered pocket for quick access. Dual zippered around closure for additional storage. Telescopic handle. 19 x 11 x 17-1/4 in. H. Black.

**BUGBZCW1645** (282301)



**D** b u g a t t i



**E** b u g a t t i



**F** b u g a t t i



All Bugatti products can be personalized. Contact us for more information.



**A** bugatti



**B** bugatti



**A HL1601 Hard Carry-On Case**

Lightweight polycarbonate and ABS. The shell flexes to absorb impact and flexes back to regain original shape. Telescopic handle system with multi-stage locking heights. Reinforced carry handles. Four multi-directional spinner wheels for effortless rolling. Built-in 3 digit combination TSA™ locks. Fully lined interior. 13 x 9 x 21-1/2 in. H. Black. **BUG374538** (374538)

**B SLG2430 Outland Duffle Bag**

Made of ultra-resistant textured polyester. Large main compartment. Lined interior with practical pockets and 2 full-width tightening straps. Padded front section with zip closure for up to 17.3 in. laptop. Bungee on the front pocket. Reinforced handles on the side, the bottom and the top of the duffel bag. Retractable telescopic handle. Two inline wheels to roll silently. 13.5 x 7.5 x 18.5 in. H. Black. **BUG 829869** (829869)



**C SLG5920 Carry-On Case**

Soft side luggage made from water-repellent material. Four multi-directional spinner wheels. Front section with multiple pockets for easy access. Up to 15.6 in. padded section for your lap top. Many inside pockets including including a waterproof removable pocket and a laundry bag. Includes 2 interior tightening straps. 21.5 x 15 x 9.2 in. Black. **BUG 829870** (829870)

**D HL14016 Carry-On Case**

Extra lightweight polyester and polypropylene. Four double spinner wheels for precise control and quiet rolling. Up to 14.1 in. padded laptop section. Lined interior including practical pockets to put your objects. Tightening straps. Telescopic handle. 14 x 8.25 x 16 in. Navy blue. **BUG 829861** (829861)



**C** bugatti



**D** bugatti



**E Reborn Travel Organizer**

Polyester. Two interior zipper compartments. External easy-access pocket. Interior mesh pocket. 9 x 6 x 4-3/4 in. Black. 100% recycled content. **BUG 829872** (829872)

**F Contrast Toiletry Bag**

Vegan leather. Several compartments. Interior pockets for organization. 6-1/2 x 8-1/2 x 4 in. **BUG 829877** (829877) black **BUG 829878** (829878) grey

**G TAC1400 Passport Wallet**

Fine Milled Napa leather. Fully integrated Identity Block™ protection. Passport holder and three card slots. 4 x 5-1/2 in. Black. **BUG377895** (377895)



**E** bugatti



**F** bugatti



Find Luggage Padlocks on **page 563**



**G** bugatti





# A bugatti

## Bugatti 2 in 1 Backpack & Briefcase from Traveller collection

Made of Polyester - Multiple compartments - Exterior front zippered pocket - Quick-access side zip pocket for small item - Hidden padded back pocket - Bottle holder - Key FOB - Padded 15.6" laptop compartment - Trolley pass-through - Easy to clean insulated bottom shoe & lunch zippered pocket - Top and side carry-handles - Padded and adjustable straps (can be hidden when not used), 12 x 6 x 17 in. H.

**BUG805334** (805334) black

**BUG805342** (805342) navy



### B Crossbody Bag

Vegan leather. Main compartment with zip-around opening. Up to 8 in. padded section tablet. Front pocket for easy access. Adjustable shoulder strap. 7 x 3 x 11 in. Black.

**BUG 829871** (829871)

### C Crossbody Bag

Vegan leather. Quick access front exterior pocket. Inside zippered pocket and organizer. 2 slip pockets. Adjustable and comfortable crossbody strap. 10 x 11-1/4 x 1-3/4 in. Black.

**BUG 829856** (829856)

### D Laptop Sleeve

Vegan leather. For laptop up to 14 in. Padded interior. Back pocket for quick and easy access. 14-1/4 x 3/4 x 10-1/2 in. H.

**BUG 599316** (599316) pink

**BUG 599308** (599308) black

### E TAC1421 Tablet Sleeve

Polyester with herringbone pattern. Zip around closure. Back zippered pocket. Padded section for 14" tablet. 13.25 x 1.5 x 10.25 in. H. Grey and black.

**For 14 in. tablet - 13-1/4 x 1-1/2 x 10-1/4 in.**

**BUG 378331** (378331)

**For 15.6 in laptop - 16 x 1-1/2 x 12 in.**

**BUG 378349** (378349)

### F Business Card Wallet

Vegan leather. ID window. Holds 50 cards. 4 x 1 x 2.75 in. H. Black.

**BUG BCC5000** (515577)

### G Business Card Holder

Polyester. Holds 128 cards. Black. 20% post-consumer recycled content.

**BUG BCC97358** (324053)



B bugatti



C bugatti



D bugatti



E bugatti



F bugatti



G bugatti



bugatti



## PURE COLLECTION Vegan leather ladies business tote

Classic and versatile, the **Bugatti** PURE business tote is designed to go through seasons with style and durability. Ideal as a business bag or as an everyday tote, you will love its quality and its versatility. Carry it on your shoulder or secure it to the handle of your suitcase while you're on the move.

### Tote Bag

#### DIMENSIONS

13.25 x 15 x 6.25 in



BUG 599357

BUG 599340

BUG 599332

*Designed to enhance your everyday.*





## A BKP2167 Moretti Business Backpack

Nylon with vegan leather details. Compartment for up to 14 in. laptop. Reinforced carrying handles. Removable strap. Wide, adjustable straps to provide adequate support. Zippered front pockets with organizational compartment. Trolley sleeve. 2 main compartments with zippers. 12-1/2 x 6 x 15 in.

**BUG 823718** (823718) black  
**BUG 823719** (823719) khaki



**A** b u g a t t i



**B** b u g a t t i



## B TTE2166 Moretti Nylon Business Tote Bag

Nylon with vegan leather details. Adjustable, padded and removable shoulder strap. Reinforced handles. Spacious main zippered compartment for laptop up to 14 in. Easy access side pockets. Attaches to the handle of a suitcase. 11-3/4 x 6 x 16-1/4 in.

**BUG823694** (823694) black

## C BKP2416 Opera Business Backpack

Vegan leather. Main compartment with zippered top and magnetic flap closure. Padded section for your laptop or tablet up to 13 in. Two inside pockets. Adjustable backpack straps for maximum comfort. Reinforced top handle for easy transport. 10.2 x 11.8 x 4 in.

**BUG 829882** (829882) black  
**BUG 829883** (829883) taupe



**C** b u g a t t i



**D** b u g a t t i



## E LBG705 Tote Bag

Vegan leather. Large main compartment with organizer pockets integrated. Up to 15.6 in. computer compartment. Integrated pencil holder. Trolley pass-through to slide it onto the telescopic handle. 16 x 6-3/4 x 12-1/2 in. H. Black.

**BUG349894** (349894)

## F BKP2382 Taylor Business Backpack

Vegan leather. Large main compartment with zipper. Reinforced handle. Padded section for up to 15.6 in. laptop. Adjustable shoulder straps. Adjustable and removable crossbody strap. Trolley pass-through.

16-1/2 x 12-1/4 x 6 in. Black.  
**BUG 829879** (829879)



**E** b u g a t t i



**F** b u g a t t i



**N**  
2023



**A** **BOSTITCH**

**N**  
2023



**B** **deflecto**

**N**  
2023



**C** **MERANGUE**

**A Konnect™ Stackable Pencil Cup**

Organizes sharpies, pens, pencils, markers, glasses, colored pencils, small notepads and other desk accessories. Plastic. 3-year limited warranty. 3-1/2 x 3-1/2 x 3-5/8 in. H. Accessories not included.

**BOS 829433** (829433) black  
**BOS 829432** (829432) white

**B Antimicrobial Pencil Cup**

Antimicrobial agent inhibits the growth of odour-causing microorganisms, and mold and mildew. 2.4 x 2.4 x 3.6 in. H. Black.

**DEF 63908** (832692)

**C Divided Pencil Cup**

3 compartments. Wire mesh. 4 x 6 in. H. Black.

**MGE MIL11998CA** (832989)

**D Mesh Pencil Cup**

Wire mesh. Jumbo size. Black.

**ROL 62557** (115873)

**E Ellype Crystal Pencil Cup**

Plastic. 4 compartments. Clear.

**GRN CEP2136111** (115931)

**F Ellype Pencil Cup**

Plastic. 4 compartments. Black. 90% recycled content.

**GRN CEP2136116** (230102)

**G Value Line Pencil Cup**

Made of 100% recycled plastic. Black.

**STX 70175U06C** (136366)

**H Mesh Pencil Cup**

Durable mesh wire with smooth finish. Black.

**WNN 12221** (231779)

**I Pencil Cup With Dividers**

Plastic. 3 sections. Black. 30% recycled content.

**DEF 34204** (238451)



**D** **ROLODEX**



**E** **cep**



**F** **cep**



**G** **STOREX**



**H** **Winnable**



**I** **deflecto**

## A Magnetic Pencil Cup

Sturdy modern design pen holder. Each compartment comes with 2 magnets so they can be attached together. Easy to assemble. 70% recycled content.  
**GMX 81000** (833141)

## B Plastic Pencil Cup

3 large compartments. 3 x 3 x 4-1/8 in. H. Made with 25% post-consumer recycled content. Black.  
**BSN 32355** (1024439)

## C Acrylic Pencil Cup

2-1/2 x 2-1/2 in. Transparent green tint.  
**LLR 80656** (1024462)

## D Mesh Paper Clip Holder

Durable mesh wire with smooth finish. Black.  
**WNN 12241** (231837)

## E Magnetic Paper Clip Dispenser

Magnetic top keeps paper clips easily accessible. Removable top and translucent base. Compact. Black/Clear  
**ACC 72351** (415349)

## F Magnetic Paper Clip Dispenser

Magnetic top keeps paper clips easily accessible. Removable top and translucent base. Compact. Black/smoke.  
**ACM 08301** (480954)

## G Mesh Paper Clip Holder

Wire mesh. Black.  
**ROL 62562** (759795)

## H Message Spike

Features rubber-tipped feet to protect surfaces. Black.  
**ACM 42146** (480756)

## I Memo Holder

Wire mesh. Holds 3 x 3 in. notes. Black.  
**LLR 84156** (1024397)



**A** GEMEXPONENT



**B** BUSINESS SOURCE®



**C** LORELL



**D** Winnable



**E** ACCO BRANDS



**F** WESTCOTT  
Depuis 1872 Since 1872®



**G** ROLODEX®



**H** WESTCOTT  
Depuis 1872 Since 1872®



**I** LORELL



**A** *cep*



**B** *STOREX*

**A Correspondence Tray**  
Plastic. Stackable. Letter size. Sold by each.  
**GRN CEP2111811** (115915) clear  
**GRNCEP2111816** (1024298) graphite

**B Value Line Correspondence Tray**  
Plastic. Stackable. Black. 100% recycled content.  
**STX 70172U12C** (136341) letter  
**STX 70171U12C** (136333) legal

**C Correspondence Tray**  
Plastic. Stackable. Black. Supports sold separately.  
100% recycled content.  
**KRR 12502** (220095)  
• Set of 4 risers  
**KRR 14000** (248781)

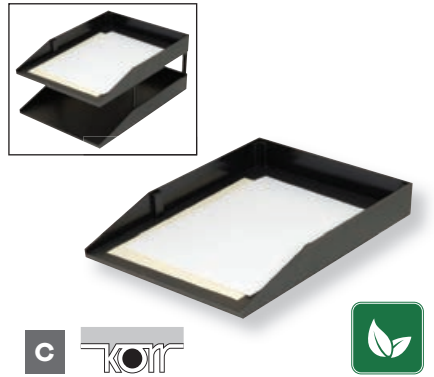

**C** *KOR*



**D** *cep*

**D Correspondence Tray**  
Large plastic tray. Stackable. Letter size. 4-1/2 in. deep. Black.  
**GRN CEP220R** (230078)

**E Mesh Correspondence Tray**  
Side loading. Stackable. Enamel wire mesh. Black.  
**WNN12321** (231860) letter  
**WNN 12326** (231894) legal

**F Correspondence Tray**  
Plastic. Letter size. Stackable. Black. 30% recycled content.  
**DEF 391104** (238535)

**G Correspondence Tray**  
Front loading. Plastic. Letter size. Stackable. Black.  
100% recycled content.  
**KRR 19002** (279190)



**E** *Winnable*



**F** *deflecto*

**H Stackable Correspondence Tray**  
Side loading. Stackable. Black. 100% recycled content,  
30% post consumer.  
**Letter size**  
**KRR 18002** (375360) by each  
**Legal size**  
**KRR27502** (618512) by each  
**KRR 27202** (543660) pkg 2

**I Correspondence Tray**  
Plastic Side loading. Stackable. Letter size. 25% post consumer  
recycled content.  
**BSN 42586** (1024371) smoke  
**BSN42587** (1024389) clear

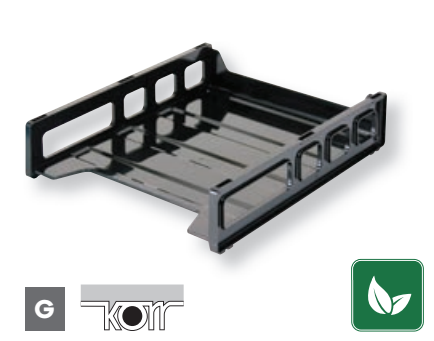

**G** *KOR*



**H** *KOR*

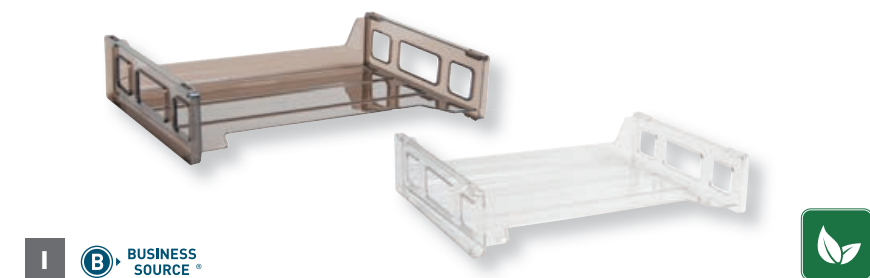

**I** *BUSINESS SOURCE*

## A Mesh Correspondance Tray

Wire mesh. Front loading. Letter size. Black.  
**ROL 22211ELD** (628552)



**A**  **ROLODEX®**

## B Mesh Stacking Tray

Wire mesh. Side loading. Letter size. Black.  
**ROL 62555** (759720)



**B**  **ROLODEX®**

## C Onyx® Letter Tray

Elegant mesh design. Made of steel with a powder-coat finish for durability. Letter size. Black.  
**SAF 3272BL** (1024306)

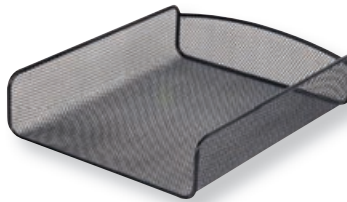

**C**  **SAFCO**

## D Antimicrobial Letter Desk Tray

SteriTouch® antimicrobial protection. Polystyrene. Letter size. Black.  
**DEF 63905** (832689)

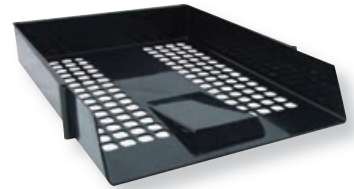

**D**  **deflecto®** 

## E Stacking Letter Tray

Durable lightweight acrylic with curved edges and non-skid feet. Transparent with hint of green.  
**LLR 80654** (1024322) by each  
**LLR 80655** (1024314) pkg 2



**F**  **deflecto®** 

## F Antimicrobial Letter Desk Tray

SteriTouch® antimicrobial protection. Polystyrene. Letter size. Black.  
**DEF 63906** (832690)



**E**  **LORELL**

## G Correspondance Basket

Front-loading wire desk tray has an indentation in the center of both ends for easier access. Wire design provides open visual access to documents and files. Deep tray allows for plenty of documents. Black.  
**ACM 42012** (535740) letter  
**ACM 42015** (560508) legal

## H Corporate Desk Tray Set

Sleek, ergonomic tray design features nonslip, anti-scratch feet. Organizer and pencil cup can be placed atop a tray or can be used alone. Plastic. Two letter-sized trays, risers, organizer and pencil cup included. 10 x 13-5/8 x 2-1/4 in. H. Black.  
**DEF 583004** (1024231)

## I Docutray Multi-Directional Stacking Trays

Holds letter, legal and A4 size documents. Interlocking design allows trays to self-stack in any direction. Curved entry lifts paper for easy access. Tray size: 10 x 13-3/4 x 2-1/2 in. Set of 2 trays. Black.  
**DEF 63904** (595926)

## J Side-Load Stacking Trays

Made from durable, break resistant plastic. Includes tall, metal risers. Tough enough to hold more than 1500 sheets of paper, heavy catalogues, and oversized files. 16-1/2 x 11-3/16 x 3-1/2 in. H. Package of 2. Black.  
**DEF 582704** (1024249)



**G**  **WESTCOTT**  
*Depuis 1872 Since 1872*

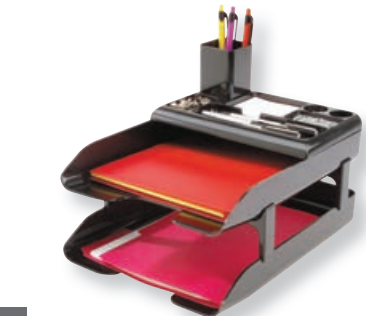

**H**  **deflecto®**

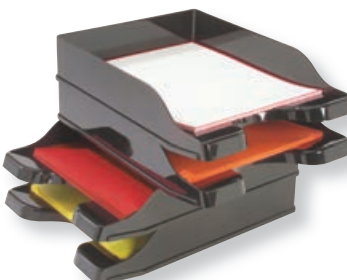

**I**  **deflecto®**

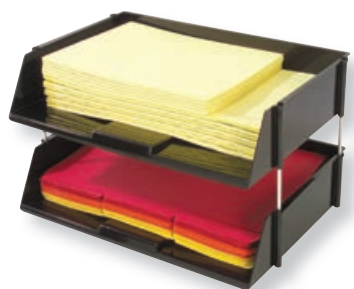

**J**  **deflecto®**



**A** **BOSTITCH**



**A Stackable Desk Organizer**

Modular design, pieces can be stacked together or used individually. Built-in USB ports and phone stand for device docking and charging. 2 storage trays, accessory tray, back channel. Cord wrap for easily managing wires and cables. Non-slip rubber feet protect surfaces. Includes 3 in. micro USB cord for power. 3-year limited warranty. 4-piece set.

**BOS 829429** (829429) black  
**BOS 829428** (829428) white

**B Antimicrobial Organizer**

SteriTouch® antimicrobial protection. Polystyrene. 5-1/2 x 4-7/10 x 3-2/3 in. Black.  
**DEF 63910** (832693)

**C Corner Desktop Organizer**

Four shelves with two side compartments. 10-7/8 x 11-1/4 x 13-1/8 in. H. Black.  
**MGE MIL11992C** (2992)



**B** **deflecto**



**C** **MERANGUE**



**D Value Line Desk Organizer**

Made of 100% recycled plastic. Black.  
**STX 70163U06C** (136457)

**E Mesh Desktop Organizer**

Wire mesh. 5-1/4 x 5-1/8 x 5 in. Black.  
**WNN 12171** (238386)

**F Small Desk Caddy**

Plastic. With dividers. Black. 30% recycled content.  
**DEF 38904** (238501)

**G Pizzaz Desktop Organizer**

Plastic. 4-1/2 x 4-1/2 x 5-3/4 in. 3 swivel drawers and 2 deep compartments. Black.  
**RUB 14095ROS** (542696)



**D** **STOREX**



**E** **Winnable**

**H Desk Organizer**

5 compartments and slot for notepad. 5-1/4 x 6-3/4 x 4-1/4 in. 100% recycled content, 30% post-consumer. Black.  
**KRR 67002** (286898)



**F** **deflecto**



**G** **Rubbermaid**



**H** **VICTOR**



## A Mesh Rotary Desk Organizer

Includes vertical compartments for writing instruments, scissors and more. Also includes low-profile horizontal compartments for paper clips, tacks and more. 6.6 x 6.6 x 6.6 in. Black.  
**MGE 833026** (833026)



**A** MERANGUE



**B** MERANGUE



## B Mesh Oval Supplies Caddy

Wire mesh. 8 compartments. Black.  
**MGE 833037** (833037)

## C All In One Caddy

6-compartment. Dedicated compartment slot in base for charger connection. Tape dispenser (tape not included). Removable centre divider for larger filing needs. 8-1/8 x 5-3/16 x 9-1/8 in. Black/silver.  
**DEF 35172** (1025288)

## D Desk Organizer

5 compartments. 6 x 6 x 6 in. H. Black. 25% recycled content.  
**BSN 11877** (1024851)

## E Revolving Desk Organizer

Spins like a Lazy Susan to keep your frequently used desktop tools and accessories within easy reach. Smooth finish resists scratches and marks to preserve its sleek appearance. Desk organizer is perfect for holding pencils, pens, markers, highlighters and more. Accessories not included. Black.  
**ACM 81010** (391318)



**C** deflecto®

**D** BUSINESS SOURCE®



## F Carousel Organizer

9 compartments. Storage organizer with clear canisters feature black snap-on lids and revolving base. 11 x 11 x 6-1/2 in. Accessories not included. Black.  
**DEF 39010104** (1025296)

## G Optimizers™ 4-Way Organizer

3 trays hold letters and folders. 2 removable drawers for small accessories. Wall mountable. Can accommodate letter size or A4 documents. 10 x 13-1/4 x 13-1/4 in. Clear.  
**RUB 94600ROS** (770412)



**E** WESTCOTT  
 Depuis 1872 Since 1872®



**F** deflecto®



**G** Rubbermaid



**A** deflecto



**B** deflecto

**A Interlocking Tilt Bins**

Modular units feature an interlocking design allowing you to mix and match sizes. Clear, removable bins keep supplies visible. Mounting hardware and labels included. Can also be mounted on cubicle walls with partition brackets (not included).

- 4 compartments**  
DEF 204040P (1025221) 23-5/8 x 6-5/8 x 8-1/8 in. H
- 5 compartments**  
DEF 205040P (311159) 23-5/8 x 5-1/4 x 6-1/2 in. H
- 6 compartments**  
DEF 206040P (311167) 23-5/8 x 3-5/8 x 4-1/2 in. H

**B Stackable Cube Organizer**

Modular organizers stack together with clips for a custom system. Drawers and dividers are removable. Includes 1 clip. 6 x 6 x 7-1/5 in.

- 2 drawers**  
DEF350101 (187146) transparent  
DEF 350104 (552240) black
- 4 drawers**  
DEF350301 (187153) transparent  
DEF 350304 (552257) black

**C Storage Cube**

Drawers open independently and are fully removable. Clear.

- 6 x 6 x 6 in.**  
BSN 82978 (1024827) 2 drawers  
BSN 82979 (1024900) X-cube  
BSN 82980 (1024843) open cube  
**6 x 7-1/4 x 6 in.**  
BSN 82977 (1024835) 4 drawers

**D Mesh Drawer Organizer**

Wire mesh. 6 compartments. 15-1/4 x 11-3/4 x 2-3/8 in. H. Black.

MGE MIL11984CA (832995)

**E Drawer Director™ Organizer**

Plastic. Extra capacity. 3 in. deep bins. 15 x 12 in. Black.

RUB 11906ROS (220657)

**F Regeneration® Drawer Tray Organizer**

9 compartments. 14 x 9 x 1-1/8 in. H. 25% post-consumer recycled content. Black.

RUB 45706 (257204)

**G Multi Compartment Organizer**

Hangs from file rails. 7 compartments will help organizing paper clips, pens, scissors, rubber bands and other small accessories.

7.8 x 3.3 x 12.5H in. Black.  
RUB 11916ROS (556332)



**C**  BUSINESS SOURCE®



**D** MERANGUE



**E** 



**F** 



**G** 





## A Mesh Business Card Holder

Enamel wire mesh. Black.  
WNN 12251 (231845)

## B Business Card Holder

Holds up to 50 cards. 3-3/4 x 1-1/2 x 1-7/8 in.  
DEF70101 (395632) clear  
DEF 90104 (561936) black

## C Acrylic Business Card Holder

Lightweight design with polished edges. Holds up to 70 cards.  
Durable acrylic.  
LLR 80657 (1025072)

## D Countertop Business Card Holder

Acrylic. Each compartment holds up to 50 cards. 4 compartments.  
3-7/8 x 4-1/8 x 3-1/2 in. Clear.  
DEF 70841 (738070)

## E Business Card Display

Acrylic. 4 compartments. Each compartment holds up to 50 cards.  
3-7/8 x 4-1/8 x 3-1/2 in. Black. 100% recycled content.  
DEF 90404 (166546)

## F Countertop Business Card Holder

Acrylic. Each compartment holds up to 50 cards. 8 compartments.  
7-7/8 x 3-5/8 x 3-7/8 in. Clear.  
DEF 70801 (561928)

## G Wall Mount Business Card Holder

Acrylic. Each compartment holds up to 80 cards. 6 compartments.  
8-3/8 x 1-1/2 x 9-3/4 in. Clear.  
DEF 70601 (552273)

## H Outdoor Business Card Holder

Mount to store front doors, vehicle windows and outdoor signs.  
Adheres to glass or smooth surfaces with the included adhesive tape  
without damaging paint. Clear plastic. Detachable mounting bracket.  
Hold 50 cards. 4-1/4 x 2-7/8 in. H.  
DEF 70901 (1040997)



**A** Winnable



**B** deflecto



**C** LORELL



**D** deflecto



**E** deflecto 



**F** deflecto



**G** deflecto



**H** deflecto

Antimicrobial protection

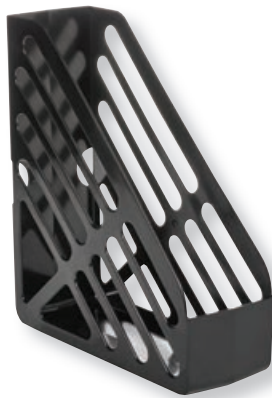

**A** **deflecto**



**B** **cep**



**A Antimicrobial Magazine File**

Accepts A4, magazines, books, folders. Extra wide for increased capacity. Finger hole for easy retrieval. 10-1/2 x 4 x 12 in. Black. **DEF 63907** (832691)

**B Magazine File**

Plastic. 3-3/10 x 11 x 12-4/5 in. **GRN CEP2136911** (115949) clear **GRN CEP2136916** (1024264) graphite

**C Value Line Magazine File**

Made of 100% recycled plastic. Black. **STX 70167U06C** (136317) by each **STX 70168U06C** (543165) pkg 2

**D Orderly™ Magazine File**

Plastic. Can be used vertically or horizontally. 9-5/8 x 3 x 12-1/2 in. H. Black. 100% recycled content. **FEL 00434** (191486)

**E Jumbo Magazine File**

Plastic. 6-1/4 x 10 x 11-7/8 in. H. 30% recycled content. **DEF 34904** (238485)

**F Large Book Bin**

Large book bins hold books, magazines, files, folders, etc. Sides of bins connect together for safe storage. Made of sturdy and drop resistant plastic. Front and rear handles for easy gripping, even with little hands. Clear pouches included for labeling. 14.3 x 5.3 x 7 in. H. Black. **STX 70109U06C** (596973)

**G Vertical Desk Organizer**

Made of durable high impact plastic. Snap in dividers create adjustable compartments. Package includes 1 file and 2 dividers. Black. **PFX 23004** (528000)



**C** **STOREX**



**D** **Fellowes**



**E** **deflecto**



**F** **STOREX**



**G** **Oxford™**

## A Mesh Bookends

Elegant look with mesh screens. 7 x 5.4 x 5.3 in. Package of 2. Black.  
**LLR 84242** (1025411)



## B Steel Bookends

Heavy gauge steel with smooth edges. Non-skid poly base will not scratch or stain surfaces. Package of 2. Black.  
**BSN 42550** (1025379) 5.3 x 5 x 4.8 in.  
**BSN 42551** (1025403) 8.5 x 9 x 6 in.



## C Mesh Magazine File

Features double-rimmed smooth edges and a powder coat finish. 12.3 x 3.2 x 10 in. Black.  
**MGE MIL11964CA** (832993)



## D Magazine File

Durable mesh wire with smooth finish. 9-7/8 x 2-3/4 x 12-3/8 in. Black.  
**WNN 12262** (535708)

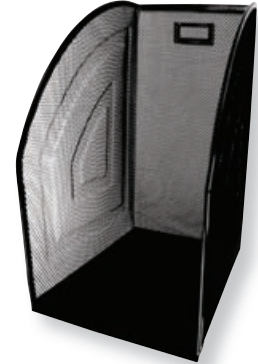
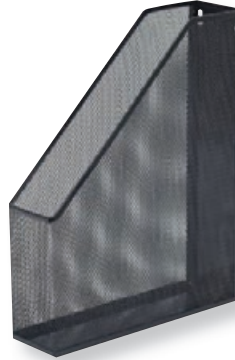

## E Magazine File

Checker design. Easy assembly. Made of thick and sturdy cardboard. 70% recycled content.  
**GMX 81002** (833143)

## F Magazine File

Corrugated cardboard. 65% recycled content, 59% post-consumer waste.  
**FEL 07223** (212894) 4 x 11-3/4 x 9"  
**FEL 07224** (212902) 4 x 10-3/8 x 12-3/4"

## G Decorative Magazine File

To store magazines, periodicals and folders. Letter size. 4-1/4 x 11-3/8 x 12-7/8"H. Package of 6 colours. 60% recycled content. SFI certified.  
**FEL 3381901** (235150)

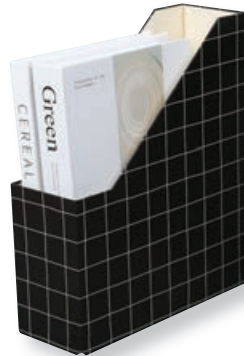



**A** **Winnable**



**B** **LORELL**

**A Mesh Mini Sorter**  
Mesh enamelled wire. Black.  
**WNN 12231** (231795)

**B Acrylic Mini Sorter**  
Durable lightweight acrylic. Nonskid feet. 2 sections.  
Transparent with green tint.  
**LLR 80659** (1024942)



**C** **cep**



**D** **MERANGUE**

**C Plastic Mini Sorter**  
Plastic. 3 compartments.  
**GRNCEP2135016** (1074970) graphite  
**GRN CEP2135011** (115923) clear

**D Mesh Super Sorter**  
7 compartments. Enamel wire mesh. 9-1/2 x 12-1/4 x 8-1/8 in. Black.  
**MGE MIL12002CA** (832996)

**E Onyx® Desk File Sorter**  
Wire mesh. Each upright section is 2 in. wide. Greenguard certified.  
Black.  
**SAF 3256BL** (1024637) 5 sections  
**SAF 3253BL** (1024653) 8 sections

**F Mesh Sorter**  
5 compartments Enamel wire mesh. Black.  
**WNN 12232** (231803)



**G Vertical Desk Sorter**  
3 compartments. Wire mesh. For letter size documents.  
12-5/8 x 3-1/2 x 11-1/2 in. Black.  
**WNN 12271** (535716)

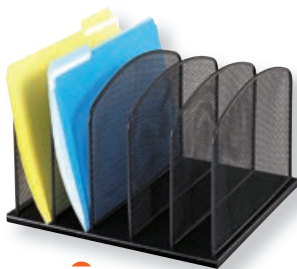

**E** **SAFCO**

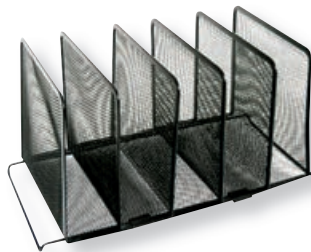

**F** **Winnable**

**H Steel Vertical Sorter**  
6 compartments and rubber feet. 11-1/4 x 12-1/4 x 8 in. Black.  
**SAF 3155BL** (288167)

**I Desk File Sorter**  
Plastic. 6 sections. 30% post-consumer recycled content. Black.  
**KRR 60002** (220079)

**J Desk Sorter**  
7 sections. Made of durable plastic. 8-3/4 x 5-1/2 x 4-3/4 in. H. Black.  
Contains 25% recycled content.  
**BSN 11876** (1024983)

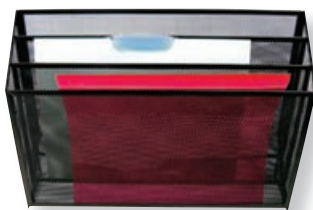

**G** **Winnable**

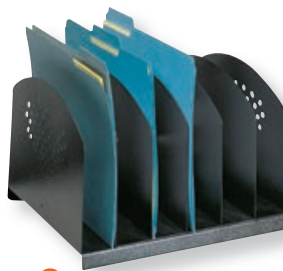

**H** **SAFCO**

**K Wire Desktop Sorter**  
Black.  
4 sections - 13 x 11 x 7-3/4 in.  
**ACM 42604** (231217)  
6 sections - 18 x 11 x 7-1/2 in.  
**ACM 42606** (231225)  
9 sections - 23-1/2 x 11 x 7-1/2 in.  
**ACM 42609** (1024488)  
12 sections - 32 x 11 x 7-3/4 in.  
**ACM 42612** (187559) 32 x 11 x 7-3/4 in.

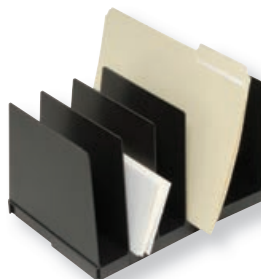

**I** **KOR**



**J** **B BUSINESS SOURCE**



**K** **WESTCOTT**  
Depuis 1872 Since 1872

**A 3-Tier Mesh Sorter**

Wall mounted or desktop use. Includes mounting hardware.  
12-3/4 x 3-1/2 x 11-1/2 in. H. Black.  
MGE MIL13190CA (832990)



**A** MERANGUE



**B** MERANGUE



**B 3-Tray Sorter**

Black wire mesh. Letter size. Black.  
MGE 832991 (832991)

**C Onyx™ Stackable Sorter**

Steel mesh construction. 9-1/2 x 12-1/4 x 1-3/4" horizontal pockets.  
Fits letter size documents or folders. Stackable. Black.  
12 compartments - 30 x 12 -3/4 x 11-1/4 in.  
SAF 9430BL (187286)  
3 compartments - 8 x 9-1/4 x 11-3/4 in.  
SAF 3271BL (596874)  
6 compartments - 10-1/4 x 12 -3/4 x 15-1/4 in.  
SAF 9431BL (237966)

**D Onyx® Horizontal Hanging Organizer**

Fits up to 1 3/4 in. thick desktop and secures with the included tightening screw. 4 compartments and a pencil tray.  
10-1/4 x 12-3/8 x 14-3/8 in. H. Black.  
SAF 3240BL (1024793) with letter tray  
SAF 3242BL (1024801) no letter tray

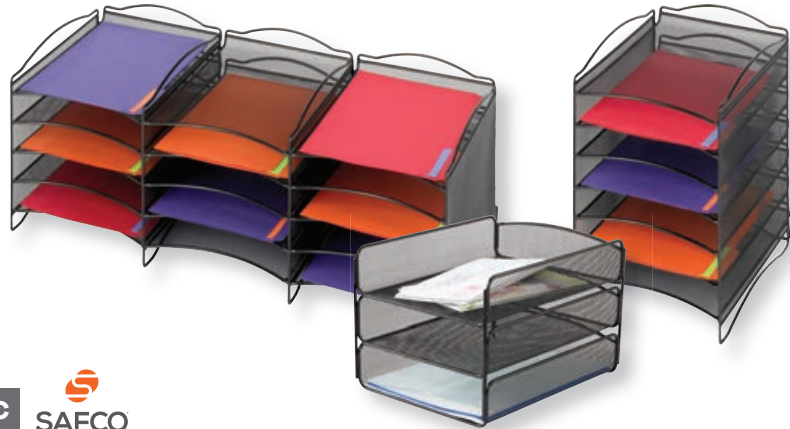

**C** SAFCO

**E Mesh 3-Tier Letter Tray**

Enamel mesh wire. 12-1/2 x 9-1/4 x 12-3/4 in. H. Black.  
WNN 12341 (231936)

**F Steel Sorter**

All steel. Rubber base. Accepts letter size documents. Black.  
6 shelves - 12 x 9-1/2 x 13-1/4 in.  
SAF 3128BL (555961)  
8 shelves - 12 x 9-1/2 x 17-3/4 in.  
SAF 3129BL (828106)

**G Optimizers™ 2-Way Organizer**

Rounded tiered design allows for easy file access. Stands upright or lays flat for various filing options. 5 letter size compartments. Clear.  
RUB 94610ROS (115899)



**D** SAFCO

**E** Winnable



**F** SAFCO

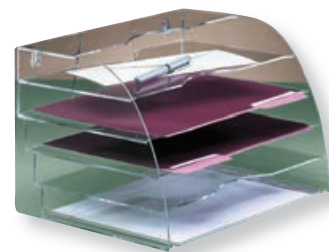

**G** Rubbermaid



**A**  **SAFCO**



**B**  **SAFCO**

**A Onyx™ Organizer With 3 Drawers**

Black wire mesh with powder coat finish. Horizontal tray is letter size.  
**SAF 3252BL** (116038)

**B Onyx™ Desktop Organizer**

Corner organizer for binders and folders. Black wire mesh with powder coat finish.  
**SAF 3261BL** (116046)

**C Mesh Combination Sorter**

2 horizontal letter-size file trays. 6 vertical file sections 2 in. wide. Black  
**SAF 3255BL** (544726)

**D Horizontal/Vertical File Sorter**

Durable mesh wire with smooth finish. Letter size.  
16-1/2 x 9 x 6-1/2 in. Black.  
**WNN 12212** (549972)



**C**  **SAFCO**



**D** **Winnable**

**E Steel Combination Sorter**

Combines 3 horizontal with 3 vertical filing compartments. Resistant powder coat finish for durability. Rubber feet included to protect work surface. 16-1/4 x 11-1/4 x 8-1/2 in. Black.  
**SAF 3167BL** (564708)

**F Onyx™ Vertical/Horizontal Desk Organizer**

Steel mesh design. 5 vertical file sections. 3 horizontal letter paper trays. 13 x 11-1/2 x 9-1/2 in. Black.  
**SAF 3266BL** (596882)

**G Onyx® Mesh Desk Organizer**

Contains three vertical sections and two slide out baskets for small items. Greenguard Certified. 17 x 6-3/4 x 7-3/4 in. H. Black.  
**SAF 3263BL** (1024752)

**H Onyx® Mesh Desk Organizer**

Contains two vertical file sections and two horizontal shelves for letter-size documents. Greenguard certified. 17 x 10-3/4 x 7-3/4 in. H. Black.  
**SAF 3264BL** (1024744)

**I Divided Desktop Organizer**

Four-tiered space for file folders. One plastic tray providing storage for small items, one pen cup hangs on the side and three extra-deep trays. 12-7/8 x 14-3/8 x 15-3/4 in. H. Black.  
**LLR 95251** (1024595)

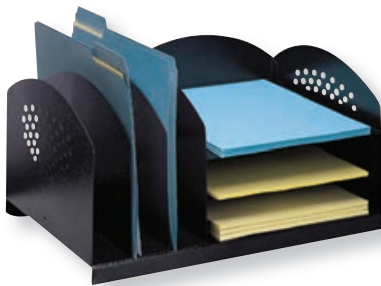

**E**  **SAFCO**

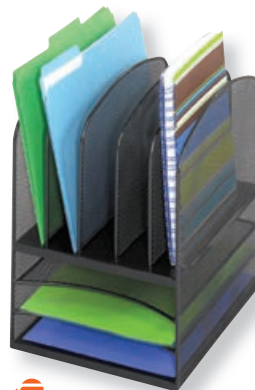

**F**  **SAFCO**

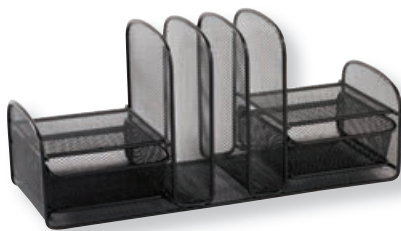

**G**  **SAFCO**



**H**  **SAFCO**

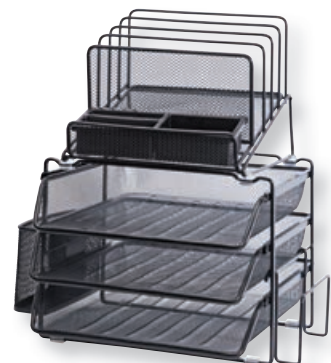

**I**  **LORELL**

**A Slant Desk File Sorter**

Wire mesh. 5 sections. Black.  
MGE MIL50672CA (832997)



**A** MERANGUE



Magnetic

**B Magnetic 3-Tier Mesh Sorter**

Wall mounted or desktop use. 12-3/4 x 3-1/2 x 11-1/2 in. H. Black.  
MGE 832994 (832994)



**B** MERANGUE



**C Onyx® Slant Desk File Sorter**

Wire mesh. Each slanted section is 1 in. wide.  
Greenguard Certified. Black.  
SAF 3258BL (1024645) 8 sections

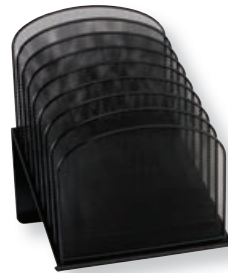

**C** SAFCO

**D Mesh Step Sorter**

Mesh enamelled wire. Black.  
WNN 12201 (231761)



**D** Winnable

**E Wire Step File**

Ideal for sorting letter or legal documents. Includes 8 stepped  
sorter compartments. 100% recyclable. Black.  
FEL 72614 (233882)

**F Wire Step File**

Sleek, open design helps keep your files in clear view and organized.  
8 sections. Black.  
ACM 42017 (394866)



**E** Fellowes

**G Value Line Vertical Sorter**

Plastic. 100% recycled. 6 compartments. 7 x 10 x 7-1/4 in. H. Black.  
Made in Canada.  
STX 70164U06C (136309)



**F** WESTCOTT  
Deposited Since 1872

**H Step Sorter**

Create an environmentally responsible, coordinated office  
with this group of plastic desk accessories. 30% recycled content.  
DEF 34504 (238469)

**I Optimizers™ Desk Sorter**

6 compartments inclined for easy viewing. Durable plastic.  
Also hangs on wall.  
RUB 96600ROS (770487) clear

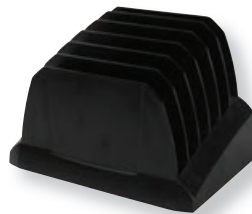

**G** STOREX



**J 6-Section Desk/Wall Organizer**

Extra-thick plastic. 3-tier design. Hangs on a wall or can lie flat  
on desktop. Letter size. 26.7 x 2.8 x 11.5"H.  
RUB 96060ROS (228718) black



**H** deflecto



Can be wall mounted



**I** Rubbermaid



**J** Rubbermaid

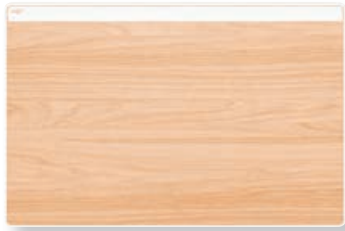

**A** *cep*

**N**  
2023



**B** **quartet**

**N**  
2023

**A Silva Desk Pad**

Phthalate-free PVC. Anti-glare transparent cover. Anti-slip soft foam base. Ideal surface for writing and computer mouse movement. Holds photo, calendar or notes in place. 23 x 15 in. Clear and beech. **GRN CEP800** (832987)

**B Glass Desk Pad**

Durable tempered glass. Non-porous, clear glass surface is easy to erase and will not stain or ghost. Can support up to 100 lbs. Rubber feet hold glass in place to avoid shifting. Write-on with glass dry-erase marker. Limited 10-year warranty. 36 x 24 x 1/4 in. Clear. **QRT Q0936240** (827993)

**C Glass Desk Pad**

Durable tempered glass. Non-slip silicone pads for stability. Will not easily scratch or discolour. Smooth writing surface. Easy to clean. Clear. **FLR FCDE1924G** (832981) 19 x 24 in. **FLR FCDE2036G** (832982) 20 x 36 in.

**D Duraglas® Desk Pad**

Transparent, anti-glare. Ideal for keeping notes close at hand. For use where desk surface needs to remain visible. Soft anti-slip back. **DBL 7112-19** (166090) 16 x 21 in. **DBL 7113-19** (166108) 19 x 26 in.



**C** **DESKTEX** BY GREENSIDE GROUP

**N**  
2023



**D** **DURABLE**

**E Polycarbonate Desk Pad**

Polycarbonate. Phthalates-free. Non-toxic. Durable. Anti-slip backing. Will not curl, crack or discolour. Lightly embossed surface for easy-glide mouse control. Easy to clean. Heat-resistant. Clear. **FLR FPDE1722RA** (832977) 17 x 22 in. **FLR FPDE1924RA** (1024116) 19 x 24 in. **FLR FBDE2036RA** (832978) 20 x 36 in. **FLR FPDE2949RA** (832979) 29 x 59 in. **FLR FPDE3571RA** (832980) 35 x 71 in.

**F World Map Desk Pad**

PVC. World map encapsulated under a welded transparent cover. Non-slip base. Comfortable writing surface. 15-3/4 x 20-3/4 in. **DBL 7211-19** (833003)



**E** **DESKTEX** BY GREENSIDE GROUP

**F** **DURABLE**

**N**  
2023



**G Transparent Desk Pad Protector**

Heavyweight clear vinyl. **GMX 924** (23234) 19 x 24 in. **GMX 930** (23242) 20 x 30 in. **GMX 936** (23259) 20 x 36 in.



**G** **GEMEX**





## A PVC Desk Pad

PVC. Flexible. Smooth writing surface. Contoured edge.  
Soft anti-slip backing. 20 x 36 in. Black.  
**DBL 7103-01** (833000)

## B Desk Pad With Clear Overlay

PVC. Flexible. Clear overlay welded at top edge keeps notes in view.  
Anti-slip foam backing. Smooth writing surface. 20 x 36 in.  
**DBL 7203-01** (833001) black  
**DBL 7203-10** (833002) grey



**A** DURABLE



**B** DURABLE



## C PVC Desk Pad

PVC. Phthalate-free. Non-toxic. Durable. Non-slip base. Smooth surface ideal for writing and computer mouse mobility. Will not dent, scratch or stain. Easy to clean.

**19 x 24 in.**  
**FLR FPDE1924BV** (832985) black  
**FLRFPDE1924CV** (832983) clear  
**20 x 36 in.**  
**FLR FBDE2036BV** (832986) black  
**FLRFBDE2036CV** (832984) clear



**C** DESKTEX BY GREENSIDE GROUP



## D Anti-Static Desk Pad

PVC. Phthalate-free. Non-toxic. Protects computer and other electronics from damage caused by static electricity. Durable. Easy to clean. Clear.

**FLR 832976** (832976) 12 x 18 po  
**FLR FPDE31924V** (832974) 19 x 24 in.  
**FLR FBDE32036V** (832975) 20 x 36 in.

## E Clear Desk Pad

Superior writing surface that will not dent, scratch or stain. The smooth surface reduces writing fatigue. The non-glare, no-slip surface provides a perfect way to protect your personal photographs and important reference materials. Resists copy lifting.

**LLR 39652** (1024207) 19 x 24 in.  
**LLR 39650** (1024158) 20 x 36 in.

**C** DESKTEX BY GREENSIDE GROUP



## F Ecotex® Clear Desk Pad

Suitable for wood or leather desk surfaces. Slightly embossed surface is perfect for mousing performance. Light tint due to being 100% recycled. 19 x 24 po. Clair

**FLR FPDE1924P** (563478)

## G Anti-Static Desk Pad

Made with renewable plant sources. Superior writing surface will not dent, scratch or stain. Greenguard certified; phthalate and cadmium free. Black.

**LLR 39655** (1024140) 19 x 24 in.  
**LLR 39654** (1024173) 20 x 36 in.



**D** DESKTEX BY GREENSIDE GROUP



**E** LORELL





**F** DESKTEX BY GREENSIDE GROUP



**G** LORELL



 <p><b>A</b> <b>Fellowes</b></p>	 <p><b>B</b> <b>vlb</b></p>	 <p><b>C</b> <b>LORELL</b></p>	<p><b>A Partition Additions™ Spring Clips</b> Package of 4. Black. 75% pre-consumer recycled content. <b>FEL 75270</b> (737403)</p> <p><b>B Panel Wall Clips</b> Spring clip with pins to keep paper in place on fabric and cork panels. 20 per box, Cream. <b>VLB 75301</b> (549873)</p> <p><b>C Cubicle Pencil Cup</b> Mounts on fabric panel or other vertical surface. Black. 30% post-consumer recycled content. <b>LLR 80668</b> (1025163)</p> <p><b>D Cubicle Nameplate Holder</b> 8-1/2 x 2 in. Clear. <b>DEF 587501</b> (561910)</p>
 <p><b>D</b> <b>deflecto</b></p>		 <p><b>F</b> <b>WESTCOTT</b> <i>Depuis 1872 Since 1872*</i></p>	<p><b>E Cubicle Nameplate Holder</b> 15/16 x 2-5/8 in. Black. 30% post-consumer recycled content. <b>LLR 80669</b> (1025189)</p> <p><b>F Hanging Step File</b> High quality wire. Universal bracket allows for easy mounting partitions 1-1/2 in. to 3 in. wide. 6 compartments. Black. <b>ACM 42019</b> (394957)</p>
 <p><b>E</b> <b>LORELL</b></p>		 <p><b>F</b> <b>WESTCOTT</b> <i>Depuis 1872 Since 1872*</i></p>	<p><b>G Hanging Triple Letter Tray</b> High quality wire. Universal bracket allows for easy mounting partitions 1-1/2 in. to 3 in. wide. 3 letter size trays. Black. <b>ACM 42023</b> (394965)</p> <p><b>H Vertical File Organizer</b> High quality wire. Universal bracket allows for easy mounting partitions 1-1/2 in. to 3 in. wide. 3 letter size pockets. 12-5/8 x 4-5/8 x 22-13/16 in.H. Black. <b>ACM 42028</b> (394973)</p>
 <p><b>G</b> <b>WESTCOTT</b> <i>Depuis 1872 Since 1872*</i></p>	 <p><b>H</b> <b>WESTCOTT</b> <i>Depuis 1872 Since 1872*</i></p>	 <p><b>I</b> <b>STORAX</b></p>	<p><b>I Partition File With Hangers</b> Unbreakable plastic. Hanger accommodates partitions 1-1/2 to 3-1/2 in. thick. Set of 3 pockets. Black. 100% post-consumer recycled content. <b>STX70315B06C</b> (277178) letter <b>STX 70316B06C</b> (277186) legal</p> <p><b>J Vertical File Organizer</b> With hangers. Mesh. 3 letter size pockets. Black. <b>ROL 21961</b> (736868)</p> <p><b>K Cubicle File Pocket</b> Letter size or A4 size. Black. 30% post-consumer recycled content. <b>LLR 80663</b> (1025635) by each <b>LLR 80666</b> (1025627) pkg 3 • Partition hangers - package of 2 <b>LLR 80674</b> (1025171)</p>
 <p><b>J</b> <b>ROLODEX</b></p>	 <p><b>K</b> <b>LORELL</b></p>		

## A Arc™ Cubicle Board

Aluminum frame. Mounts to cubicle or drywall. Height adjustable mounting clips.

### Cork bulletin board

**QRT 3413803882** (790865) 30 x 18 in

### Combination board

**QRT 3413803878** (790832) 30 x 18 in

### Magnetic dry-erase calendar

**QRT 3413803879** (278481) 30 x 18 in

### Magnetic dry erase whiteboard

**QRT 3413803881** (790857) 24 x 14 in

**QRT 3413803880** (790840) 30 x 18 in



## B Combination Cubicle Board

Dry-erase board and cork board. Magnetic lacquered steel dry erase surface. Aluminum frame. Mounting hooks included. 10 years surface warranty.

### Whiteboard - 36 x 18 in.

**BVC XA10003700** (1040055)

### Planning calendar - 24 x 18 in.

**BVC MB3507186** (1042191)

## C Magnetic Dry Erase Board

High-impact plastic. 3 medium size magnets included. 16 x 13 in.  
**LLR 80664** (1039809)

## D Cubicle Sign Holder

Includes mounting clips for fabric cubicles. Hold letter size documents. Clear.

**DEF 588601** (1040989)

## E Over the Panel Coat Hook

Plastic with reinforced steel back plates. Mounting hardware included and concealed within hook. Fits panels from 1-1/2 up to 3-1/4 po and doors up to 1-3/4 in. Black.

**SAF 4224BL** (358390) single

**SAF 4225BL** (428318) double

## F Onyx™ Partition Mesh Coat Hook

Wire mesh construction. Curved hook. Fits over partitions and doors up to 1-1/2 to 2-1/2 in. thick. Black.

**SAF 4229BL** (439620)

## G Coat Hook

For partitions 1-1/2 in. to 3 in. wide. 2 hooks. Black.

**ACM 42021** (394940)



Find board accessories on **pages 263, 264 and 286**





**A** **deflecto**



**B** **deflecto**

**A DocuPocket® Unbreakable Wall Pockets**

Unbreakable plastic will not crack or break. Includes mounting hardware.

- Letter size**  
**DEF63201** (499012) clear  
**DEF 63202** (530907) smoke  
**Legal size**  
**DEF 64301** (1025552) clear  
**DEF 64302** (1025569) smoke

**B EZ Link® Stackable DocuPocket®**

- Black.  
**Single file**  
**DEF 73204** (100248) letter  
**DEF 74304** (100289) legal  
**3-file set**  
**DEF 73604** (100255) letter  
**DEF 74104** (100271) legal  
**7-file set**  
**DEF 73704** (100263) letter  
**DEF 74704** (100297) legal  
 • **Set of 2 adjustable brackets**  
**DEF OPBKT04** (138487)



**C** **deflecto**



**D** **deflecto**

**C EZ Link® Single DocuPocket®**

Single wall file holds a generous amount of materials. EZ Link® mounting screws included. Multiple pockets stack together with linking pins.

- Letter size**  
**DEF 73201** (1025536) clear  
**DEF73202** (1025544) smoke  
**Legal size**  
**DEF 74301** (1025510) clear  
**DEF 74302** (1025528) smoke

**D EZ Link® Stackable DocuPocket®**

- 3-file set. Letter size.  
**DEF73601RT** (523522) clear  
**DEF 73602RT** (544536) smoke  
 • **Set of 2 adjustable brackets**  
**DEF 391204** (1025619)

Magnetic

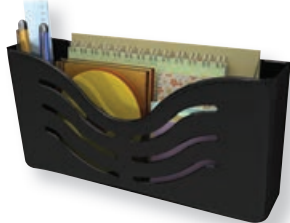

**E** **deflecto**



**F** **deflecto**

**E Magnetic Supply Organizer**

For use on magnetic surfaces. Includes removable divider, magnets, mounting screws and push pins. 10 x 5 x 2-5/8 in. Black.  
**DEF 73304H** (523514)

**F DocuPocket® Vertical Wall Pocket**

Letter size. Made of strong, unbreakable plastic. Includes mounting hardware. 10-1/4 x 10 x 4 in. Clear.  
**DEF 63001** (595884)

**G Stand-Tall® Wall Mount File Pocket**

Break resistant. High tension bracket keeps literature upright. Over 2 po capacity. 9-1/4 x 1-3/4 x 10-5/8 in. Clear.  
**DEF 65501** (288886)

**H Mesh Wall File**

Metal wire mesh. Letter size. Black.  
**ROL 21931** (638858)



**G** **deflecto**



**H** **ROLODEX**

## A Wall File

Made from unbreakable polycarbonate.  
**Single file, letter size**  
**RUB 65972ROS** (662866) clear  
**RUB 65970ROS** (629469) smoke  
**Single file, legal size**  
**RUB 65980ROS** (662882) clear  
**Set of 3 files, letter size**  
**RUB 65976ROS** (662874) clear  
**RUB 65974ROS** (629477) smoke



**A** Rubbermaid

Magnetic



**B** Rubbermaid



## B Unbreakable Magnetic Wall File

Made of durable polycarbonate. Letter size. Sticks to any metal surface.  
**RUB65986** (662890) clear  
**RUB 65988** (662908) smoke

## C Black Magic Magnetic Wall File

Made from steel mesh with four heavy-duty magnets to attach to metal surfaces. Letter size. Black.  
**SAF 4176BL** (1025478)



**C** SAFCO

Magnetic



**D** SAFCO

## D Onyx™ Wall Pockets

Steel-mesh construction with black powder finish. Mounting hardware included. Black.  
**Single file**  
**SAF 5651BL** (138511) letter  
**SAF 5653BL** (138537) legal  
**Set of 3 pockets**  
**SAF 5652BL** (138529) letter

## E Steel Wall Pocket

Steel pockets. Powder-coated finish. Black.  
**Single file**  
**SAF 3170BL** (773721) letter  
**SAF 3171BL** (773739) legal  
**Set of 3 pockets, letter size**  
**SAF 3172BL** (774166)



**E** SAFCO



**F** SAFCO



**G** STOREX

## F 7-Compartment Wall File

Sturdy steel with black powder coat finish. For letter/legal filing.  
 9-1/2 x 2 x 21-3/4 in. H.  
**SAF 3185BL** (187278)

## G Unbreakable Wall File

Polycarbonate  
**Single file, legal size**  
**STX 70321U06C** (277194) clear  
**STX 70361U06C** (277228) black  
**Set of 3 files, letter size**  
**STX 70313U06C** (277160) clear  
**STX 70353U06C** (277202) black



**H** STOREX



**I** STOREX

Magnetic



## H Wall Files

Three types of mounting hardware included: wall anchors and screws, double sided tape, and pocket clips. Tough poly construction. Holds file folders and documents. PVC and BPA free.

**Set of 2 files, letter size.**  
**STX70209B06C** (172478) black  
**STX 70214B06C** (172494) smoke  
**STX70223B06C** (239186) clear  
**Set of 2 files, legal size.**  
**STX70210B06C** (172486) black  
**STX70210B06C** (172502) smoke  
**STX70224B06C** (239194) clear  
**Set of 6 files, letter size.**  
**STX 70216B04C** (172528) black  
**STX 70218B04C** (172544) smoke  
**STX 70262B04C** (428003) clear  
**Set of 6 files, legal size.**  
**STX 70217B04C** (172536) black  
**STX 70219B04C** (172551) smoke  
**STX 70261B04C** (427997) clear

## I Magnetic Wall File

Made of sturdy and durable plastic. Mounts on any metal surface. Holds 500 sheets of paper. Black.  
**STX 70227B06C** (427989) letter  
**STX 70226U06C** (189084) legal

## J Mesh Wall File Set

Set of 3 wall files. Enamel wire mesh. Letter size.  
 14 x 3-1/4 x 8-1/2 in. H. Black.  
**WNN 11951** (231738)



**J** Winnable

 <p><b>A</b></p> <p>CHAIRES HORIZON SEATING</p> <p><b>N</b> 2023</p> <p></p>	 <p><b>B</b></p> <p>Dainolite </p> <p><b>N</b> 2023</p> <p></p>	<p><b>A Multifunctional Foldable LED Light</b> 6 brightness levels. No glaring, ghosting, or flickering. Multi-angle adjustable head and arm. 80% less energy than incandescent lamps. Timer &amp; Memory Function: 30 mins/60 mins. Built-in USB port. <b>HZN TL01S</b> (828074) silver <b>HZN TL01B</b> (828075) black</p> <p><b>B LED Desk Lamp</b> Integrated LED light. Integrated dimming system. Produces up to 90% more efficient light than incandescent lighting. Adjustable arm with eye-catching design. 8 watts. 450 lumens. 22 in. high. Black. <b>DIN 829389</b> (829389)</p>
 <p><b>C</b></p> <p>Dainolite </p> <p><b>N</b> 2023</p> <p></p>	 <p><b>D</b></p> <p>Dainolite </p> <p><b>N</b> 2023</p> <p></p>	<p><b>C LED Table Lamp with Magnifier</b> Adjustable LED lighting, with its convenient and versatile range of formats, will add both style and directional illumination to living rooms, bedrooms and office spaces. 18 x 6 x 20 in. Black. <b>DIN 121LEDT-BK</b> (829390)</p> <p><b>D 8W Table Lamp</b> Design features an integrated LED light. An easy-care plastic base in black holds an adjustable arm, with an adjustable round LED at the top. Modern. 5.5 x 5.5 x 15 in. Matte black. <b>DIN 829391</b> (829391)</p>
 <p><b>E</b></p> <p><b>BOSTITCH</b></p> <p><b>N</b> 2023</p> <p></p>	 <p><b>F</b></p> <p><b>BOSTITCH</b></p> <p><b>N</b> 2023</p> <p></p>	<p><b>E LED Konnect Desk Lamp</b> Built-in USB port. Flexible silicone collar to easily position the light area. Dimmer function with three (3) brightness levels. Easy to use, touch sensitive power control. 7 x 7 x 9 in. <b>BOS 829417</b> (829417) black <b>BOS 829418</b> (829418) gray <b>BOS 829416</b> (829416) white</p> <p><b>F LED Konnect Desk Lamp with Wireless Charger</b> Wireless charging pad. Two built-in USB ports to quickly power up Qi-enabled devices and various electronics. 5 dimmable brightness levels. Swiveling lamp head folds 180° and rotates 90°. Flicker-free light zone. 400 lumens. 5W. Gold. <b>BOS 829419</b> (829419)</p>
 <p><b>G</b></p> <p><b>DAC ERGONOMICS</b></p> <p>Integrated air purifier</p> <p><b>N</b> 2023</p> <p></p>	 <p><b>H</b></p> <p><b>Royal Sovereign</b></p> <p><b>N</b> 2023</p> <p></p>	<p><b>G MP-331 LED Desk Lamp</b> Integrated air purifier with replaceable HEPA filter. 2 USB charging ports. 3 dimmable lighting modes (natural, white, yellow). 7-colour mood light integrated at the base. 40-minute auto-off timer. 220 lumens. 17.5 in. high. White. <b>DTA 02358</b> (829421) • Package of 2 HEPA MP-334 filters <b>DTA 02380</b> (829422)</p> <p><b>H LED Desk Lamp with Wireless Charging</b> Multi-angle adjustments, including light temperature. Touch sensor controls, independent night light and a fast charging Qi compatible wireless charging base. 180° left/right and 115 up/down head rotation. Black. <b>RSI RDL1400QI</b> (829468)</p>
 <p><b>I</b></p> <p><b>Royal Sovereign</b></p> <p>UV-C sterilizer drawer</p> <p><b>N</b> 2023</p> <p></p>	 <p><b>J</b></p> <p><b>DAC ERGONOMICS</b></p> <p><b>N</b> 2023</p> <p></p>	<p><b>I LED Desk Lamp with Wireless Charging</b> Adjustable light angle and brightness control. Includes convenient wireless charging of Qi enabled devices and nightlight option. Use the UV-C drawer to safely and effectively sterilize 99.9% of germs and bacteria from your smartphone and other items. White. <b>RSI 829469</b> (829469)</p> <p><b>J LED Monitor Lamp</b> Clips to nearly any monitor. 3 dimmable lighting modes. 40 minute auto-off timer. USB power cable included. Black. <b>MP-333 - 11 in. wide - 150 lumens</b> <b>DTA 02362</b> (829424) <b>MP-332 - 15 3/4 in. wide - 200 lumens</b> <b>DTA 02360</b> (829423)</p>

**A LED Desk Lamp: 5-in-1**

Adjustable light mode. Each light temperature mode is dimmable. 120° up/down head rotation. 90° arm rotation. USB port. Magnetic charging base. AirPods charging base. Black.  
**RSI RDL1100UQI** (829470)



**B Puck LED Desk Lamp**

Task lamp designed for small spaces. 3 watts, 250 lumens. Adjustable head lamp for better lighting. Acrylic accents. 5" base, 14-1/4" high. Silver/black.  
**BOS VLED1510** (350454)



**C Umbriel LED Desk Lamp**

Fully flexible goose neck for light where you need it. Dimmable with multi-level touch on/off. USB port conveniently charges your devices. Swivel lamp head. Contains no mercury or harmful chemicals. 5 watts, 380 lumens. 16.5"H. Black.  
**BOS VLED1505** (429506)



**D RDL-150QI LED Desk Lamp**

With wireless charging station. Swing arm and 3-way multi-angle lamp head. Wireless charger included. Touch controls and stepless dimming. 3 light modes. Up to 40,000 hours LED life. 550 lumens, 10 watts.  
**RSI RDL150QI** (596924)



**E LED Desk Lamp with 340° Rotating Head**

Metal construction with heavy weighted base. 3 brightness levels. Lamp head 340° rotation, 90° swivel. Flicker-free and glare-free lighting. 5 watts, 450 lumens. 18 in. high.  
**DTA 02345** (597005) white  
**DTA 02341** (597013) black

**F RDL-75U LED Desk Lamp**

The adjustable gooseneck and swivel lamp. Touch sensor controls. Stepless dimming. Power on indicator light strip. USB charging port included. 3 brightness levels. 8 watts, 480 lumens. 15 in. high.  
**RSI RDL75UB** (805722) black  
**RSI RDL75UW** (805714) white



**G Sport LED Desk Clamp Lamp**

Fully flexible goose neck for positional lighting. Soft touch silicone finish with acrylic accents. Clamp has suction pads and will open to 2". High powered LED, 5.5 W, 500 lumens. 13-3/4"H. Black.  
**BOS 429530** (429530)

**H RDL-140Qi LED Desk Lamp**

Stepless dimming. Includes independent night light. Touch sensor controls. Wireless charging for Qi supported devices. 3 brightness levels. 10 watts, 600 lumens. 17.7 in. high.  
**RSI RDL140QIB** (805730) black  
**RSI RDL140QIW** (805748) white

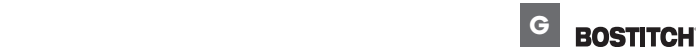

**BOSTITCH**

**A Swing Arm LED Lamp with Clamp**

Fully adjustable swing arm. Attached clamp for desktop mounting. Extensive 36-in reach easily clears monitors and other objects. All-metal durable construction. Flicker-free light zone. White.

**BOS VLF100-WHT** (829420)



**B LED Magnifier Clamp Lamp**

8 watts. 760 lumens. Extension of 47 in. 5" diameter lens, 5 diopter lens.

**DIN DMLED10ABK** (579698) black

**DINDMLED10AWH** (579706) white



SEQUENCE	CODE	REFERENCE	ENERGY STAR CERTIFIED	DESCRIPTION	COMMON INDUSTRY #	SIZE	WATTS	VOLTS	PACKAGE	PRICE
C	SDN S8449	1042779		Tube T8, 48", High Perf, 4100K, CRI 85, Meets RoHS, 2950 Lumens	F32T8/84/ENV	48"L x 1" Dia.	32	120	6	
D	SDN S3408	1042720		Reflector Flood, 65BR30, Indoor, 2,000 Hr, 685 Lumens	65BR30/FL	5.38"L x 3.75" Dia.	65	130	1	
E	SDN S2248	1042738		Reflector Flood, Halogen/Xenon, 60PAR38, Indoor/Outdoor, 1090 Lumens	60PAR38/HAL/XEN/FL/120V	5.38"L x 3.75" Dia.	60	120	1	
E	SDN S2259	1042746		Reflector Flood, Halogen/Xenon, 80PAR38, Indoor/Outdoor, 1600 Lumens	80PAR38/HAL/XEN/FL/120V	5.38"L x 3.75" Dia.	60	120	1	
F	SDN S7247	1042647		CFL, Reflector Flood, R30, Indoor, 2700K, CRI 82, 700 Lumens	15R30/E26/2700K/120V/1Pk	5.38"L x 3.75" Dia.	15W=65	120	1	
G	SDN S7201	1042655		CFL, Reflector Flood, PAR38, Indoor/Outdoor, 2700K, CRI, 1100 Lumens	23PAR38/E26/2700K/120V	5.04"L x 4.75" Dia.	23W=90	120	1	
H	SDN S29596	1042754		LED, 95A19, Warm White, 2700K, Non-Dimmable, 15,000hr, 800 Lumens	95A19/LED/27K/ND	4.38"L x 2.38" Dia.	9.5W=60	120	4	
I	SDN S9496	1042761		LED, 65WMR16, 3000K, Dimmable, 25,000hr, 500 Lumens	65WMR16/LED/40/30K/12V	2.56"L x 1.97" Dia.	6.5W=50W	12	1	
J	SDN S8310	1072621		CFL, Mini-Twin T4 Tube, 13W, 2 Pin GX23 Plug (Exit Sign), CRI 82, 800 Lumens	CFS13W/827	7.64"L x 1.38"W x .87"D	13W=60	120	1	
K	SDN S6235	1042670		CFL, T2 Spiral Tube, 13W, 2700K, CRI 82, 12,000 hrs, 900 Lumens	13T2/E26/2700K/120V	4.13"L x 1.81" Dia.	13W=60	120	4	
L	SDN S7335	1042662		CFL, T4 Spiral Tube, 40W, 4100K, CRI 82, 2600 Lumens	40T4/E26/4100K/120V	7.28" L x 2.64" Dia.	40W=150	120	1	
M	SDN S7291	1072639		CFL, A19, 15W, 2700K, CRI 82, 800 Lumens	15A19/E26/2700K/120V	5.39"L x 2.64" Dia.	15W=60	120	1	
N	SDN S2405	1042688		A19, Halogen/Xenon 29W, "Soft White", =40W, 430 Lumens	29A19/HAL/ES/SW/120V	4.44"L x 2.38" Dia.	29W=40	120	2	
N	SDN S2406	1042696		A19, Halogen/Xenon 43W, "Soft White", =60W, 750 Lumens	43A19/HAL/ES/SW/120V	4.44"L x 2.38" Dia.	43W=60	120	2	
N	SDN S2407	1042704		A19, Halogen/Xenon 53W, "Soft White", =75W, 1050 Lumens	53A19/HAL/ES/SW/120V	4.44"L x 2.38" Dia.	53W=75	120	2	
N	SDN S2408	1042712		A19, Halogen/Xenon 72W, "Soft White", =100W, 1490 Lumens	72A19/HAL/ES/SW/120V	4.44"L x 2.38" Dia.	72W=100	120	2	



**A Wall Clock**

12/24 hour. 12 in. diameter with black rim. Quartz movement. Requires one AA battery (not included). Black.  
**GBC 9847027** (290254)



**A** Bates

**B Wall Clock**

12" diameter. Glass lens. Metal hands. Quartz sweep silent movement. Uses one AA battery (not included).  
**SWI 23001** (546747) black  
**SWI 27007** (550806) faux wood finish

**C Wall Clock**

10" diameter display with glass. Quartz precision. Uses 1 AA battery, not included.  
**GCI 81042** (789271) black  
**GCI 81042W** (789289) white

**D Wall Clock**

12/24 hr. display with glass. 12" diameter. Quartz precision. Uses 1 AA battery, not included. Black.  
**GCI 81298** (789305)

**E Wall Clock**

Plastic cover. Quartz movement. Black frame. Requires one AA battery (not included). 9 in. diameter.  
**LLR 60987** (1042969)

**F Quiet Wall Clock**

Features large 3D numbers showcased in a slender profile. Super-quiet. Requires one AA battery (not included). 12 in. diameter. Black frame.  
**LLR 61011** (1042993)

**G Digital Timer**

Jumbo LCD display. 60 minute register. 30-minute alarm. Requires 1 AAA battery, included.  
**BML DT122** (169565)



**B** *Swingline*



**C** **GEO**



**D** **GEO**



**E** **LORELL**



**F** **LORELL**



**G** **BIOS**  
H<sub>2</sub>O



# Work. Collaborate. Create.



# Anywhere.

Quartet® has the tools and solutions you need to be productive from anywhere. At the office, at home or on the go, Quartet® will help you work, collaborate and create.



Glass dry-erase boards provide professional, upscale appeal without sacrificing any of the durability of a classic whiteboard. Magnetic boards offer dual functionality as a magnetic bulletin board, while others are non-magnetic for standard functionality. Frameless board design blends seamlessly into any environment. Glass boards leave no ink trace. Available in multiple sizes and colours.



## A InvisiMount™ Vertical Glass

### Dry-Erase Board

Frameless board design blends seamlessly into any environment. Tempered glass will not stain or ghost. Magnetic surface allows board to double as a display surface for printed documents and notes. 20-year warranty. White.

**QRT Q012850IMW** (829490) 28 x 50 in.

**QRT Q014274IMW** (829491) 42 x 72 in.

**QRT Q014885IMW** (829492) 48 x 85 in.



## B InvisiMount™ Magnetic Glass

### Dry Erase Board

Frameless board design blends seamlessly into any environment. Tempered glass will not stain or ghost. Magnetic surface allows board to double as a display surface for printed documents and notes. 20-year warranty. White.

**QRT 3413822330** (385161) 39 x 22 in.

**QRT 3413822331** (385179) 50 x 28 in.

**QRT 3413822332** (385187) 74 x 42 in.

**QRT 3413822333** (385195) 85 x 48 in.

## C Infinity™ Glass Dry Erase Board

Frameless design. Highly durable tempered glass surface resists ghosting, staining, scratching and denting. For frequent use. Easy to install vertical or horizontal with included pass-through mounting hardware. Marker tray included. 15-year warranty.

### Magnetic, white

**QRT 20113** (249219) 18 x 24 in.

**QRT 20114** (249227) 36 x 24 in.

**QRT 20115** (249235) 48 x 36 in.

**QRT 20116** (249243) 72 x 48 in.

### Magnetic, black

**QRT 20118** (249250) 18 x 24 in.

**QRT 20119** (249268) 36 x 24 in.

**QRT 20121** (249276) 48 x 36 in.

**QRT 20122** (249300) 72 x 48 in.

### Non-magnetic, frosted

**QRT 20108** (279752) 36 x 24 in.

**QRT 20109** (279836) 48 x 36 in.

**QRT 20111** (279844) 72 x 48 in.

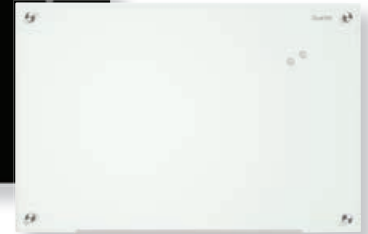
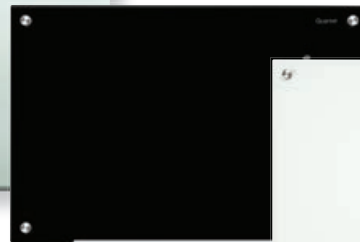
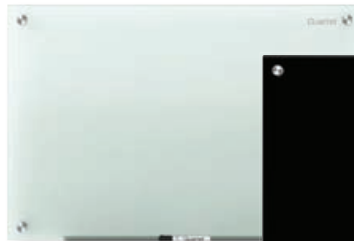

## D Dry Erase Glass Board

Solid glass panel will not stain. Ultra-white frosted surface. Works with all dry erase markers. Steel bolts hide the mounting hardware (included). Limited lifetime warranty.

**LLR 52502** (1039882) 36 x 48 in.

**LLR 52500** (1039890) 36 x 72 in.





**A** MasterVision®



**B** MasterVision®



**A Magnetic Dry Erase Glass Board**

Durable magnetic glass surface. Easy to clean and maintain. Never stains. Suitable for extensive use. White.  
**BVC GL040107** (831288) 18 x 24 in.  
**BVC GL080107** (831289) 36 x 48 in.

**B Magnetic Glass Dry Erase Board**

Frameless. Durable magnetic glass surface. Easy to clean and maintain. Never stains. Suitable for extensive use. No visible mounting hardware. 24 x 36 in. White.  
**BVC GL070101** (831290)

**C Glass Desktop Dry Erase Pad**

Designed to maximize space between keyboard and monitor. Tempered safety glass will not stain or ghost. Built-in marker tray. Accessory drawer under the pad. White. 18 x 6 in.  
**QRT 3413829987** (424614)



**C** quartet



**D** quartet

**D Desktop Glass™ Dry Erase Easel**

Frameless glass easel. Replaces paper notes. Position easel upright to keep notes in view. 11 x 9 in. White.  
**QRT 3413829986** (585638)

**E Desktop Glass™ Dry-Erase Panel**

Self-standing 17 x 23 in. dry erase magnetic panel. Two-sided surface.  
**QRT 3413826909** (585646)

**F Max Clean™ Dry Erase Board Eraser**

Works on all dry erase surfaces, optimized for use on glass boards. Store in the included magnetic caddy, or place directly on a magnetic surface. 6 x 2-3/8".  
**QRT 3413899250** (572651)

**G Glass Board Eraser**

Super strong magnet for use on glass boards. 5 x 2 in.  
**LLR 52559** (1040211)

**H Large Rare Earth Magnets for Glass Board**

Very strong. Package of 6.  
**QRT853917** (279893) clear  
**QRT 3413885392** (597419) assorted colours

**I Glass Dry Erase Board Cleaner**

Fast drying formula. Eco-friendly. Phosphate free. 503 ml.  
**QRT 3413826651** (597401)



**E** quartet



**F** quartet



**G** LORELL



**H** quartet



**I** quartet



## A Prestige® 2 Porcelain

### Magnetic Dry Erase Whiteboard

DuraMax® porcelain will not scratch, dent, stain or ghost. Aluminum frame. Pass-thru mounting hardware included. Full length marker tray. Lifetime surface warranty.

**QRT 20146** (247734) 48 x 36 in.

**QRT 3413820149** (247759) 72 x 48 in.

**QRT 20156** (247775) 96 x 48 in.



## B Classic Premium

### Magnetic Dry-Erase Board

DuraMax® porcelain will not scratch, dent, stain or ghost. Mounting hardware included. 4 assorted markers and marker tray included. Aluminum frame. Lifetime surface warranty.

**QRT 25430** (494393) 36 x 24 in.

**QRT 25440** (494401) 48 x 36 in.

**QRT 25470** (494419) 72 x 48 in.

**QRT 25480** (606418) 96 x 48 in.

## C Prestige® 2 Total Erase®

### Magnetic Dry Erase Whiteboard

Highly durable magnetic surface resists ghosting, staining, scratching and denting. Light grid pattern guides straight writing. Pass-thru mounting system. Full length marker tray. 20-year warranty.

#### Aluminum frame

**QRT 20057** (247833) 48 x 36 in.

**QRT 20058** (247866) 72 x 48 in.

**QRT 20059** (247908) 96 x 48 in.

#### Graphite frame

**QRT 20061** (247924) 48 x 36 in.

**QRT 20062** (247932) 72 x 48 in.



## D Magnetic Dry Erase Whiteboard

Premium scratch resistant porcelain surface. Tray clips onto frame in any position. Can be mounted horizontal or vertically. Mounting hardware included.

**BVC CR0601170** (831291) 36 x 24 in.

**BVC CR0801170** (831292) 48 x 36 in.

**BVC CR1201170** (831293) 72 x 48 in.

## E Infinity™ Magnetic Glass

### Dry Erase Calendar Board

Frameless design. Highly durable magnetic surface resists ghosting, staining, scratching and denting. Perpetual one month calendar. English. 15-year warranty.

**QRT 20078** (279877) 36 x 24 in.

**QRT 20106** (279885) 48 x 36 in.

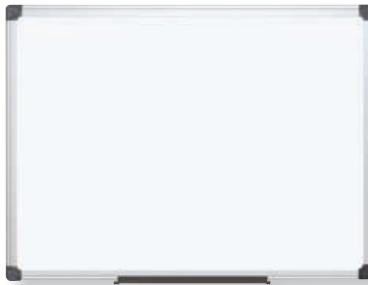

## F Prestige® 2 Magnetic Calendar

### Dry Erase Whiteboard

Durable Total Erase® surface. Moderate use. Easy-to-use mounting hardware. Full length marker tray. Quartet dry-erase marker included. Undated calendar. English.

#### 1 month

**QRT 20128** (279901) 36 x 24 in.

#### 3 months

**QRT 20127** (279968) 36 x 24 in.

#### 4 months

**QRT 20125** (280032) 48 x 36 in.



Glass board





**A** 

**N**  
2023



**B** 

**A Classic Magnetic Dry Erase Whiteboard**

Smooth, durable surface that stands up to moderate use. Aluminum frame. Attached marker tray. Mounting hardware included. 5-year warranty.

- QRT SM531** (829493) 24 x 18 in.
- QRT SM533** (829494) 36 x 24 in.
- QRT SM534** (829495) 48 x 36 in.
- QRT SM537** (829496) 72 x 48 in.
- QRT SM538** (829497) 96 x 48 in.

**B Standard Dry Erase Whiteboard**

Anodized aluminum frame. White melamine surface. Can be mounted horizontally or vertically. Non-magnetic. Marker tray included.

- QRT 53100** (606426) 24 x 18 in.
- QRT 53300** (606434) 36 x 24 in.
- QRT 53400** (606442) 48 x 36 in.
- QRT 53500** (426114) 60 x 36 in.
- QRT 53700** (606459) 72 x 48 in.
- QRT 53800** (606467) 96 x 48 in.



**C** 



**D** 

**C Economy Magnetic Dry Erase Whiteboard**

Durable melamine surface. Mounting hardware and marker tray included. Aluminum frame. Can also be hung from cubicle walls (hangers sold separately).

- QRT 23230** (417295) 36 x 24 in.
- QRT 23340** (417311) 48 x 36 in.
- QRT 23460** (44271) 72 x 48 in.
- QRT 23480** (417345) 96 x 48 in.

- **Package of 2 partition hangers**
- QRT 75010** (278382)

**D Economy Dry Erase Whiteboard**

Durable melamine surface. Can be mounted horizontally or vertically. Mounting hardware and marker tray included. Aluminum frame.

- QRT 32123** (135129) 24 x 18 in.
- QRT 32230** (179010) 36 x 24 in.
- QRT 32347** (181925) 48 x 36 in.
- QRT 25146** (44222) 72 x 48 in.
- QRT 25148** (44230) 96 x 48 in.



**E** 



**F** 

**E Matrix® Magnetic Dry Erase Whiteboard**

Modular design allows to connect multiple boards together. Full width marker tray. Wall mounting hardware included. Can also be hung from cubicle walls (hangers sold separately). 5-year warranty.

- QRT M1616** (736918) 16 x 16 in.
- QRT M2316** (736926) 23 x 16 in.
- QRT 02843** (736934) 23 x 23 in.
- QRT M3423** (736942) 34 x 23 in.
- QRT M4831** (736959) 48 x 31 in.

- **Package of 2 partition hangers**
- QRT MCH10** (737015)

**F Dry Erase Magnetic Whiteboard**

Includes a marker, two magnets and mounting hardware.

- Silver frame**
- QRT 03869** (521369) 8.5 x 11 in.
- White frame**
- QRT 03801** (545913) 11 x 17 in.
- QRT 03803** (538116) 17 x 23 in.



**H** 

**H Dry Erase Whiteboard**

Magnetic surface and plastic frame. Includes magnetic marker, two magnets and mounting hardware. Assorted frame colours.

- QRT 3413803799** (237651) 8-1/2 x 11 in.
- QRT 3413803800** (237636) 11 x 14 in.

**G Espresso™ Home Décor Dry Erase Whiteboard**

Dry-erasable surface. Dark frame. Includes 2-pc magnet, marker and eraser. Hanging hardware included.

- QRT 3413803830** (163659) 11 x 17 in.
- QRT 3413803831** (163667) 17 x 23 in.
- QRT 6447415516** (163592) 24 x 36 in.

## A Double-Sided Dry Erase Whiteboard

Non-magnetic melamine dry-erase surface. For occasional use. Double-sided board allows you to flip it over for twice the life. Market tray and mounting hardware included. Aluminum frame. 80% post-consumer content.

**BVC MA0300790** (1039908) 36 x 24 in.  
**BVC MA0500790** (1039791) 48 x 36 in.  
**BVC MA2700790** (1039916) 72 x 48 in.

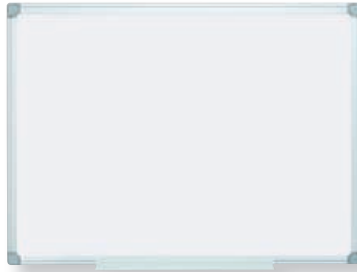

**A** MasterVision®



**B** LORELL

## B Aluminium Dry-Erase Boards

Magnetic white board with aluminium frame and galvanized steel backing. Foam bars along sides to post notes with push pins. Comes with a marker tray.

**LLR 52511** (1039841) 24 x 36 in.  
**LLR 52512** (1039859) 36 x 48 in.  
**LLR 52513** (1039866) 48 x 72 in.

## C Aluminum Frame Dry-Erase Boards

White coated styrene surface that is easy to write on with dry erase markers and just as easy to erase. Hanging hardware and marker tray included.

**LLR00586** (1039932) 24 x 36 in.  
**LLR00587** (1039940) 36 x 48 in.  
**LLR 00502** (1039958) 48 x 72 in.  
**LLR 00503** (1039965) 48 x 96 in.



**C** LORELL



**D** LORELL

## D Economy Aluminum Frame Melamine Boards

White melamine surface that is easy to write on with dry erase markers and just as easy to erase. Hanging hardware and marker tray included.

**LLR 19769** (1040518) 18 x 24 in.  
**LLR 19770** (1040039) 24 x 36 in.  
**LLR 19771** (1040047) 36 x 48 in.

## E Wood Frame Dry-Erase Boards

Feature brown wood frames and melamine surface. Marker tray included.

**LLR 84167** (1040062) 24 x 36 in.  
**LLR 84168** (1040070) 36 x 48 in.  
**LLR 84169** (1040088) 48 x 72 in.  
**LLR 84170** (1040096) 48 x 96 in.



**E** LORELL



**F** LORELL

## F Aluminum Frame Dry Erase Board

Laminated styrene dry erase boards with sturdy aluminium frame. Surface resists scratching. Marker tray included.

**LLR 55650** (1067602) 18 x 24 in.  
**LLR 55651** (1067610) 24 x 36 in.  
**LLR 55652** (1067628) 36 x 48 in.  
**LLR 55653** (1067636) 48 x 72 in.  
**LLR 55654** (1067644) 48 x 96 in.



**G** LORELL

## G Signature® Series Magnetic Dry-Erase Boards

Coated steel surface. Framed board includes marker tray, hanging hardware, eraser and dry-erase marker. Limited 5 year warranty.

**LLR 69652** (1039999) 36 x 48 in.  
**LLR 69653** (1039817) 48 x 72 in.  
**LLR 69654** (1039825) 48 x 96 in.

## H Magnetic In/Out Board

Easy to update and change steel backed magnetic personnel board works with both wet and dry-erase markers. Features aluminum frame. Bilingual.

**24 x 18 in., 15 names.**  
**QRT 72028** (738146)  
**24 x 36 in., 36 names.**  
**QRT 72029** (757351)

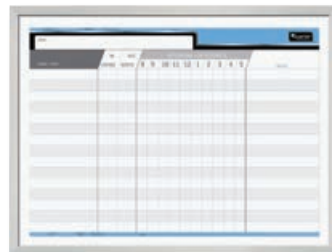

**H** quartet

## I Magnetic In/Out Board

Durable porcelain surface with black frame. Includes magnets and dry erase marker. For 18 employees. 14 x 11 in.

**QRT 750** (1041573)

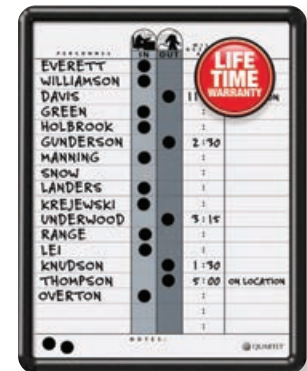

**I** quartet

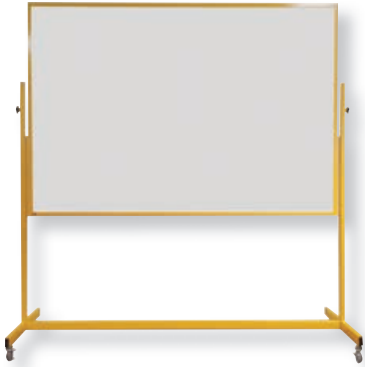

**A**  quartet



**B**  quartet

**A Industrial Magnetic Reversible Mobile Easel**

Mobile presentation easel offers triple functionality: magnetic whiteboard, Magnetic bulletin board and flipchart stand. Highly visible yellow frame. Whiteboard measures 72 x 48 in.  
**QRT 6447415871** (430512)

**B Prestige® 2 Magnetic Mobile Presentation Easel**

Functions as whiteboard, magnetic bulletin board and flipchart stand. Total Erase® Surface. Reversible, with built-in accessory tray. Board surface is 72 x 48 in. Locking caster wheels. 15-year warranty.  
**QRT 20207** (280065)

**C Mobile Dry Erase Easel**

Sleek, modern design. Durable tempered glass resists staining and ghosting. Magnetic surface doubles as a bulletin board. Full accessory tray for easy access to all of your tools. Mobile base with 3 locking casters, Reversible. 48 x 36 in. 71 in. high.  
**QRT 20209** (1040799)



**C**  quartet



**D**  quartet

**D Dual Track Magnetic Mobile Dry-Erase Easel**

Double dry-erase surface. Sliding panels allows to use full surface and keep notes at eye level. Magnetic surface can be used as a bulletin board. Aluminium frame. Includes 1 dry erase marker and 2 magnets. 2 panels of 40-1/2 x 34 in. Limited 10-year warranty.  
**QRT 3413826914** (572719)

**E Magnetic Whiteboard Screens**

Mobile dry erase whiteboard moves effortlessly. Includes accessory hooks for easel pads, magnetic accessory tray for dry erase markers and eraser. Four casters (two locking). Limited lifetime warranty. Easy assembly. 51 lbs. 42 x 72 in. H.  
**SAF 8511BL** (1040451) black  
**SAF 8511GR** (1040468) grey

**F Two Sided Magnetic Dry Erase Easel and Room Divider**

Double-sided whiteboard that can be used as a dry-erase surface and magnetic bulletin board. Aluminum frame with 4 casters. 37-1/2 x 82-1/2 in. H. Limited 5 year warranty.  
**LLR 55630** (1040906)



**E**  SAFCO



**F**  LORELL

**G Post-It® Easy Erase Surface**

Quickly transform a work surface into a whiteboard. Use dry erase and permanent markers without stains. Clean with just water, even permanent marker. Sticks securely, removes cleanly.  
**MMM FWS3X2** (806398) 3 x 2 ft.  
**MMM FWS4X3** (806406) 4 x 3 ft.  
**MMM FWS6X4** (806414) 6 x 4 ft.  
**MMM FWS8X4** (806422) 8 x 4 ft.

**H Post-It® Dry-Erase Surface Board**

Instant and flexible whiteboard solution to revive a ghosted surface and even to convert your chalkboard into a white board. Innovative adhesive sticks on finished wood, glass, painted steel, painted drywall, table tops, etc.  
**MMM DEF3X2-C** (347336) 36 x 24 in.  
**MMM DEF4X3-C** (347344) 48 x 36 in.  
**MMM DEF6X4-C** (347351) 72 x 48 in.  
**MMM DEF8X4-C** (347369) 96 x 48 in.



**G**  Post-it



**H**  Post-it

Find Whiteboards for Cubicles on **page 249**



# Whiteboard Accessories | Boards and Easels

## A Expo® Brush

For dry erasable boards.  
SAN 81505 (109553)



## B Microfiber Whiteboard Eraser

Magnetic microfiber cloth. Removes and eliminates residual dust.  
Magnetic holder. Washable. 12 x 12 in. Black. Package of 2.  
QRT 15802 (253146)

## C Magnetic Whiteboard Eraser

Magnetic for easy storage and access. Includes 3 adhesive refill pads.  
QRT 6447415800 (278176)

## D Magnetic Whiteboard Eraser

Will adhere to magnetic whiteboards. Easy grip. Assorted colours.  
JIF ERT-MM (456517)



## E Expo® Precision Whiteboard Eraser

For whiteboards. With replaceable, peel-off 8-layer pad. Stores on the white board. Magnets and double-sided tape included.  
SAN 8473KF (700146)  
• Refill  
SAN 9287KF (700153)

## F Whiteboard Eraser

Specially designed for marker boards. Washable and durable.  
Collects unwanted marker dust for extra cleanliness.  
QRT 20335 (790923)



## G Premium Magnetic 3 in 1 Eraser

Offers 3 in 1 cleaning for chalkboards and whiteboards. The felt pad is reversible for two cleaning surfaces and a third microfibre surface offers deeper cleaning. 2 x 6 x 1-3/8 in. H.  
QRT 3413841040 (1040690)

## H Expo® Cleaner

For dry erasable boards. Non-toxic.  
SAN 81803 (109561) 256 ml  
SAN 1752229 (179556) 650 ml  
SAN 81800 (179549) 3.8 liters



## I Dry-Erase Board Cleaner

Spray on and wipe off marker ink, dirt and grease. Removes ink stains and ghosting in an instant. Non-toxic formula. 237 ml.  
QRT 20070 (113563)

## J Dry Erase Board Conditioner and Cleaner

Cleans, conditions and restores surfaces. Removes ink stains and cleans surface to perform like new. Non-toxic formula. 237 ml.  
QRT 551 (163576)



## K Dry Erase Board Wipes

Cleans and restores whiteboard surfaces. Will not damage nail polish. Non toxic and low odour. Made with plant base ingredients.  
Distributor pack of 70 wipes.  
QRT 18003 (351775)



## L Expo® Cleaning Towels for Whiteboards

Non-toxic. Removes persistent marks and stains. Distributor pack of 50 wipes.  
SAN 81850 (398172)

 <p><b>A</b>  </p>	 <p><b>B</b> </p>	<p><b>A Magnetic Push Pins</b> Package of 20 in assorted colours. <b>QRT 59931</b> (100453)</p> <p><b>B Magnets</b> Assorted colours: blue, pink or green. One colour per card. <b>Round</b> <b>MAP 051100</b> (164186) 10 mm (8) <b>MAP052200</b> (164202) 22 mm (4) <b>MAP052700</b> (164210) 27 mm (4) <b>Rectangular</b> <b>MAP 051200</b> (164194) 27 mm (8)</p>
 <p><b>C</b> </p>	 <p><b>D</b>   </p>	<p><b>C Translucent Magnets</b> 1-1/8 in. diameter. Package of 6. Assorted colours <b>VLB 61218</b> (549899)</p> <p><b>D Round Magnets</b> Ceramic. Package of 20. Assorted colours. <b>QRT 90200</b> (278192) 1/2 in. <b>QRT 90301</b> (773580) 3/4 in.</p> <p><b>E Board Magnets</b> Super-strong magnets. 1-1/4 in. Package of 10. Silver. <b>BVC IM130809</b> (1042259)</p>
 <p><b>E</b>  </p>	 <p><b>F</b> </p>	<p><b>F Assorted Magnets</b> Tub of 12 small, 12 medium and 6 large magnets in assorted colours (red, yellow, blue, green). <b>LLR 21557</b> (1067511)</p> <p><b>G Magnetic Mesh Caddy</b> Attractive mesh caddy with heavy duty magnets. Organize and store whiteboard supplies. Black. <b>MGE 1018317120</b> (547943) 5.9 x 3.5 x 2.3 in. <b>MGE 1018317220</b> (547950) 8 x 3.1 x 3.9 in.</p>
 <p><b>G</b> </p>		<p><b>H Grid Tape for Boards</b> Make permanent lines on presentation boards. In a roll. 54 ft. x 1/16 in. Black. <b>QRT 96001</b> (278184)</p> <p><b>I Magnetic Grid Tape for Boards</b> Make permanent lines on presentation boards. In a roll. Adhesive on one side, magnetic on the other. 25 ft. x 1/2 in. Black. <b>QRT 3413895101</b> (483909)</p> <p><b>J Magnet Strips</b> 1/2 x 24 in. Package of 5 strips. <b>VLB 61222</b> (558692) black <b>VLB 61223</b> (567370) white</p>
 <p><b>H</b>  </p>	 <p><b>I</b> </p>	<p><b>K Magnetic Adhesive Tape</b> For filing cabinets, refrigerators, rackings and lockers. Roll of 10 ft. x 1 in. Black. <b>VLB 61240</b> (790949)</p> <p><b>L FileMode Adhesive Magnetic Tape</b> For filing cabinets, refrigerators, rackings and lockers. With dispenser. 16 ft. x 1 in. Black. <b>VLB 61245</b> (790956)</p>
 <p><b>J</b>  </p>	 <p><b>K</b> </p>	 <p><b>L</b> </p>

## A Chalkboard

Oak frame. Black writing surface. 36 x 24 in.  
**QRT 3413878401** (654277)



## B Chalk

Non-toxic. Box of 12.  
**CYO 51-0312** (9266) white  
**CYO 51-0812** (9308) assorted colours

## C Sanigene® Dustless Chalk

Non-toxic. Box of 144.  
**CYO 51-1406** (9241) white  
**CYO 51-6144** (9290) assorted colours

## D Hygieia® Chalk

Certified non-toxic. Box of 12.  
**DIX 31144** (588285) white  
**DIX61400** (1040542) assorted colours



## E Chalk Holder

Pen-style chalk holder offers a portable, easy and mess-free way to write with chalk. Easy to hold and use. Convenient pocket clip. Brushed aluminum.  
**ACM 03504** (493106)

## F Dry Erase/Chalkboard Eraser

Noiseless and dustless. Can be used on both chalkboards and dry erase boards. 5 in.  
**ACM 21102** (210351)

## G Standard Chalkboard Eraser

Noiseless and dustless. Six strips of highly absorbent wool felt - red, white and blue felts securely attached to shaped hardwood back. 5 in.  
**ACM 21104** (210369)

## H Chalkboard Eraser

Top-quality felt, all sewn eraser. Noiseless and dustless. 6 in.  
**LLR 1** (1067503)

## I Presentation/Project Board

Perfect for presentations and school projects. Sturdy white corrugate. Fold out sides for an instant 36 x 48 in. display.  
**QRT 70523** (136671)

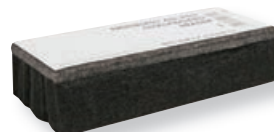



**A**  quartet

**A Prestige® Bulletin Board**

Black embossed high density foam. Self-healing properties eliminates pinholes. Euro™ aluminum/titanium finish frame. 15 years warranty  
**QRT B364T** (644260) 48 x 36 in.  
**QRT B367T** (774018) 72 x 48 in.



**B**  quartet

**B Prestige® Bulletin Board**

Black embossed high density foam. Self-healing properties eliminates pinholes. Aluminum frame. 15-year warranty.  
**QRT B343A** (644278) 36 x 24 in.  
**QRTB344A** (644286) 48 x 36 in.  
**QRT B347A** (774000) 72 x 48 in.



**C**  quartet

**C Cork Board Oak Frame**

Natural finish. 10-year warranty.  
**QRT 3413830100** (606285) 24 x 18 in.  
**QRT 3413830300** (606293) 36 x 24 in.  
**QRT 3413830400** (606301) 48 x 36 in.  
**QRT 3413830700** (606319) 72 x 48 in.  
**QRT 3413830800** (606327) 96 x 48 in.



**D**  quartet

**D Cork Board Aluminum Frame**

Natural cork surface. One-piece anodized satin finish aluminum frame. 10-year warranty.  
**QRT 3413802301** (494880) 24 x 18 in.  
**QRT 3413802303** (494898) 36 x 24 in.  
**QRT 3413802304** (494427) 48 x 36 in.  
**QRT 3413802305** (426106) 36 x 60 in.  
**QRT 3413802307** (494435) 72 x 48 in.  
**QRT 3413802308** (606400) 96 x 48 in.



**E**  quartet

**E Cork Bulletin Board**

Natural. Aluminum frame. Economy quality.  
**QRT 736124** (229146) 24 x 18 in.  
**QRT736231** (229153) 36 x 24 in.  
**QRT 736348** (229179) 48 x 36 in.  
**QRT 35146** (44123) 72 x 48 in.  
**QRT 35148** (44131) 96 x 48 in.

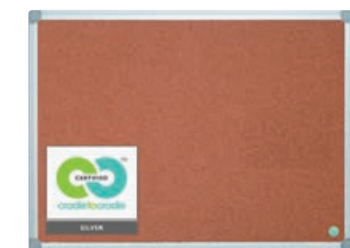

**F** **MasterVision®**

**F Earth™ Aluminum Frame  
Cork Board**

Resilient, self-healing cork surface is self-healing. Mounting hardware included. C2C certified.  
**BVC CA051790** (1042274) 36 x 48 in.  
**BVC CA271790** (1042282) 48 x 72 in.



**G** **LORELL**

**G Enclosed Cork Bulletin Board**

Aluminum frame. Polystyrene cover on locking door. For indoor use. Limited 5 year warranty. 36 x 24 in.  
**LLR 42706** (1041698)



**H**  quartet

**H Cork Boards**

Natural. Wooden frame.  
**QRT 3413835912** (100438) 24 x 18 in.  
**QRT 3413835923** (100446) 36 x 24 in.



**I**  quartet

**I Espresso™ Home Décor Cork Board**

Extra wide dark frame. Includes hanging hardware. Brown cork.  
**QRT 3413803828** (163634) 17 x 23 in.  
**QRT 6447415518** (163642) 24 x 36 in.

## A Fabric Covered Boards

Matching decor wood MDF frame. Mount vertically or horizontally. Includes mounting hardware. 18 x 24 in.  
**BVC FB0471168** (1042225) black  
**BVC FB0470608** (1042233) grey

## B Black Mesh Fabric Covered Bulletin Boards

Satin anodized aluminium frame. Mounting hardware included.  
**LLR 75697** (1041839) 24 x 36 in.  
**LLR 75696** (1041847) 36 x 48 in.

## C Combination Board

Combining a melamine white surface and natural cork surface. Solid oak frame. Full-length marker rail. 36 x 48 in.  
**QRT 55400** (682997)

## D Standard Combo Whiteboard/Bulletin Board

Half in cork and half magnetic dry erase. Include 1 dry erase marker, 2 magnets and mounting hardware. Espresso finish (dark brown). 17 x 23 in.  
**QRT 03834** (546648)

## E Cork-Dry Erase Combo Board

Attached accessory tray keeps markers, tacks and push pins close at hand. Mounts vertically or horizontally. Comes with a dry-erase marker. Oak frame. 24 x 36 in.  
**QRT 78506** (1041855)

## F Combo Dry Erase and Fabric Board

Unique metallic steel dry erase surface, paired with stylish fabric. Wood MDF frame. Includes mounting hardware. 18 x 24 in.  
**BVC MX04433168** (1042209) black  
**BVC MX04331608** (1042217) grey

## G Dry Erase and Cork Combo Boards

Combination board made of half non magnetic dry erase and half cork bulletin board. Includes marker tray. Aluminium frame with rounded black corners.  
**LLR 19290** (1041706) 18 x 24 in.  
**LLR 19291** (1041714) 24 x 36 in.



**A** MasterVision®



**B** LORELL

**C** quartet



**D** quartet

**E** quartet



**G** LORELL

**F** MasterVision®



**A** **LORELL**



**B** **LORELL**

**A Cork Panel**  
Naturel cork. 12 x 12 in. 4 panels.  
**LLR 84172** (1041862)

**B Cork Roll**  
Naturel cork. 24 x 48 in.  
**LLR 84173** (1041870)

**C Bulletin Bar**  
Natural, self-sealing cork strip in 1 in. wide anodized aluminum frame. Includes double-sided tape and magnetic strips for easy mounting to most surfaces. Push pins included. 36 in.  
**QRT 2005** (1041623)

**D Bulletin Bar**  
Self sealing cork strips in aluminium frame. Easy to mount by adhesive foamed tape and magnetic strip. Three push pins included. 5 year warranty.  
**LLR 49532** (1067271) 18 in.  
**LLR 49533** (1067289) 24 in.  
**LLR 49534** (1067297) 36 in.  
**LLR49535** (1067305) 48 in.



**C** **quartet**



**E Map Pins**  
4 mm diameter head and 12 mm steel point. Box of 100. Assorted colours.  
**ACM 00174** (398842)



**D** **LORELL**

**E** **WESTCOTT**  
Depuis 1872 Since 1872\*

**F Flag Pins**  
Great for pinpointing important locations on a map. Use on walls, corkboards and bulletin boards. Box of 25. Assorted colours.  
**ACM 33005** (484006)

**G Push Pins**  
Plastic head. Can be used on walls, corkboards and bulletin boards. Box of 100.  
**ACM 11165** (116236) clear  
**ACM 11166** (116244) white  
**ACM 11161** (116194) black  
**ACM 11142** (116186) assorted colours



**F** **WESTCOTT**  
Depuis 1872 Since 1872\*



**G** **WESTCOTT**  
Depuis 1872 Since 1872\*

**H Push Pins**  
Plastic head. Box of 100. Assorted colours.  
**ACC 71605** (232611)

**I T-Pins**  
High quality steel with nickel plate. Use to secure documents to boards or fabric cubicle walls. Box of 100.  
**BSN 32350** (1059468) 1.5 in.  
**BSN 32351** (1059476) 2 in.

**J Nickel Plated Thumb Tacks**  
1/2 in diameter and 5/16 in pin. Box of 100.  
**ACM 00522** (306159)



**H** **ACCO BRANDS**



**I** **BUSINESS SOURCE**



**J** **WESTCOTT**  
Depuis 1872 Since 1872\*



## A Prestige® 2 Magnetic Mobile Presentation Easel

Functions as whiteboard, magnetic bulletin board and flipchart stand. Total Erase® Surface. Whiteboard size: 36 x 24 in. Adjustable height from 67 to 77 in. Locking caster wheels. 15-year warranty. **QRT 20205** (280057)



## B Mobile Presentation Easel

Sturdy glass surface that cleans easily to prevent ghosting or staining from extensive use. Adjustable easel pad clips. Marker tray included. Locking casters. Limited lifetime warranty. Whiteboard size: 26 x 38-1/2 in. **BVC GEA4850126** (831287)



## C 2-Sided Mobile Presentation Easel

Its adjustable design allows you to easily change the height of either board to present information at a comfortable viewing level. Fully adjustable pad clamps accommodate any size easel pad. Board size: 30 x 42 in. 59 x 75 in. H. **BVC EA49145016** (1040872)



## D Futura™ Presentation Easel

Dry erase whiteboard surface. Non-magnetic. Converts for tabletop use. Adjustable height from 40 to 67 in. Whiteboard size: 27 x 36 in. Includes pencil tray and paper pad holder. **QRT 51900** (237073)



## E Economy Presentation Easel

24 x 36 in. melamine whiteboard included. Adjustable frame height up to 58-1/2 in. Pad not included. **QRT 51300** (493825)

## F Standard Presentation Easel

Tripod easel with magnetic white board and flipchart pad retainer. Full length accessory tray. 27 x 35 in. **QRT 02855** (737114)



## G Height Adjustable Easel

To fit on a table or the floor. No-pinch pad holder lets you quickly display any size easel pad. Folds for easy transportation and storage. Full-length pen tray. Board size 27 x 35 in. Silver. 27 x 45 in. H. **BVC EA2300335M** (1040880)



## H Two-Sided Dry Erase Easel

Melamine dry erase board. Adjustable board height. Board size 24 x 36 in. Black powder coated, sturdy steel frame. Easel includes a marker tray and flip chart clip. 24 x 67 in. H. **LLR 55629** (1040732)



## I Write-on Anywhere™ Static Dry Erase Sheet

Attaches easily to any flipchart or easel. Sheets are charged with static electricity so that it sticks to walls. No adhesive. Reusable up to 20 times. Perforated sheets. Tears into flip chart size sheets. Gives 15 sheets reversible (approx. 40 ft). White. 24.4 x 31.5 in. H. **QRT 3413885563** (280040)



## J Write-On Cling-On Conference Pad

Easy type sheets that cling to the wall using an electrostatic process. Micro-perforated plastic sheets can be used dry-erase or permanent markers. Erasable and reusable with non-permanent markers. Package of 35 sheets. 27" x 34" **BLI B24391CA** (386615)



 <p><b>A</b>  quartet</p>	 <p><b>B</b>  quartet</p>	 <p><b>C</b>  LORELL</p>	<p><b>A Black Magic Easel</b> With rings and holder for conference pad. <b>QRT 87700</b> (438408)</p> <p><b>B Aluminum Tripod Easel</b> Telescopic legs from 38 to 66 in. Can hold up a maximum weight of 25 lb. <b>QRT 50E</b> (436329)</p> <p><b>C Telescoping Aluminum Easel</b> Adjustable tubular legs with twist design to hold legs in place. Locking cross brace ensures rigidity. Rubber anti-skid feet. Black. 66 in. H. <b>LLR 75683</b> (1040815) • <b>Conference pad holder</b> <b>LLR 32109</b> (1067586)</p> <p><b>D Instant Easel</b> Sets up in seconds and folds to fit inside a briefcase. 63 in. full height, 15 in. folded. Supports up to 5 lb. Black. <b>QRT 29E</b> (606590)</p>
 <p><b>D</b>  quartet</p>	 <p><b>E</b>  MasterVision®</p>	 <p><b>F</b>  quartet </p>	<p><b>E Table Top Display Easel</b> Strong metal construction supports up to 5 lb. No-skid rubber feet ensure secure placement on smooth surfaces. Folds for storage and transportation. Black. 14-1/2 in. H. <b>BVC FLX07201</b> (1040898)</p> <p><b>F Conference Pad</b> Gummed and punched conference pads fit all standard easels. Double drills for both 17-1/2 in. and 18-1/2 in. centered holes. 50 sheets per pad. <b>Newsprint, 20 x 30 in. By each.</b> <b>QRT 789601</b> (278366) plain <b>Newsprint, 24 x 36 in. By each.</b> <b>QRT 789603</b> (435750) plain <b>Newsprint, 24 x 36 in. Package of 2.</b> <b>QRT 789604</b> (411793) plain <b>Bond paper, 20 x 30 in. By each.</b> <b>QRT 789600</b> (278374) plain <b>Bond paper, 24 x 36 in. By each.</b> <b>QRT 789803</b> (435768) plain <b>QRT 789903</b> (278556) ruled <b>QRT 789912</b> (278564) quadruled <b>Bond paper, 24 x 36 in. Package of 2.</b> <b>QRT 789804</b> (411801) plain <b>QRT 3413889904</b> (411819) ruled</p>
 <p><b>G</b>  Post-it </p>	 <p><b>H</b>  Post-it </p>	 <p><b>I</b>  Post-it</p>	<p><b>G Super Sticky Conference Pad</b> Pad of 30 sheets that will stick to most surfaces. Bleed resistant. 25 x 30 in. Plain. White. <b>MMM 559</b> (278523) pkg 2 <b>MMM 559VAD4PK</b> (424325) pkg 4 <b>MMM 559VAD6P</b> (424465) pkg 6</p> <p><b>H Recycled Super Sticky Easel Pad</b> Pad of 30 self-adhesive sheets. 25 x 30-1/2 in. Plain, white. Package of 2. 100% recycled content, 30% post-consumer. <b>MMM 559RP</b> (424200)</p> <p><b>I Self-Adhesive Big Notes</b> Share your big ideas! Self-adhesive surface. For best wall hang, use a smooth surface and position the adhesive stripes horizontally. 11 x 11 in. Package of 30 sheets. <b>MMM BN11C</b> (514695) yellow <b>MMM BN11G</b> (792671) green <b>MMM BN11O</b> (788836) orange</p>
 <p><b>J</b>  Post-it</p>	 <p><b>K</b>  Post-it</p>	<p><b>J Table Top Easel Pad</b> Self-standing and easy to set up. Perfect for on-the-go presenter. 20 x 23 in. Pad of 20 sheets. <b>MMM 563R-C</b> (738153)</p> <p><b>K Post-It® Conference Pad</b> Self-adhesive surface. Pad of 20 plain white sheets. <b>MMM 566</b> (716308) 20 x 23 in. (pkg 2) <b>MMM 577S</b> (594887) 15 x 18 in. (by each)</p>	



## A Rotary Magazine Display

30 pockets. 1 in. capacity for each pocket. Mesh wire construction. 3-sided and rotates 360°. Black. 16-1/2 x 16-1/2 x 66 in. H.  
SAF 5577BL (135780)

## B Rotary Brochure Display

Welded wire construction. Each layer rotates independently for easy selection. Five casters, two locking. Charcoal powder coat finish. 15 x 15 x 60"H.

**16 compartments - for magazines**

SAF 4139CH (771865)

**32 compartments - for leaflets**

SAF 4128CH (771840)

## C Portable Literature Display

6-shelf collapsible design. Includes carrying case. Silver aluminum. 11-1/2 x 14-1/2 x 60"H.

DEF 791061 (163311)

## D Onyx® Literature Floor Rack

Feature steel mesh construction and a mesh backdrop. 12-1/2 x 18-1/2 x 46 in. H. Limited lifetime warranty. Black. Greenguard certified.

SAF 6461BL (1041409)



**A** SAFCO



**B** SAFCO

Collapsible and portable



**C** deflecto®

## E Literature Holder

Wall mounting or freestanding. Grey.

**8 sections - for magazines**

DEF 52209 (601815)

**12 sections - for leaflets**

DEF 52809 (610568)

## F Steel Magazine Racks

Mounts to a wall or stands on the floor with steel base (sold separately). Durable texture powder coat finish. Pocket measures 9 x 3/4 x 7-1/4 in. H. Limited lifetime warranty. Greenguard certified.

**11 pockets - 10 x 4 x 36-1/4 in. H**

SAF4321BL (1041292) black

SAF 4321GR (1041300) grey

**23 pockets - 10 x 4 x 65-1/2 in. H**

SAF 4322BL (1041326) black

SAF4322GR (1041334) grey

## G Onyx™ Literature Wall Holder

Perfect for reception area. Wire mesh. Cascading. Fully assembled. Wall mounting hardware included. Letter size. 10-1/4 x 3-3/4". Black.

**5 compartments - 28-1/4 in. H**

SAF 5578BL (785162)

**10 compartments - 50-3/4 in. H**

SAF 5579BL (785170)

## H Outdoor Literature Box

Break-resistant and weatherproof. Includes mounting hardware. 10 x 13-1/8 x 4-1/2 in. Clear.

DEF 790901 (523530)



**D** SAFCO



**E** deflecto®



**F** SAFCO



**G** SAFCO



**H** deflecto®



**A** SAFCO



**B** SAFCO

**A Luxe™ Literature Holder**

Silver coated, brushed aluminum frame and clear acrylic pockets. Center pocket dividers allow for the pockets to be sized for magazines or pamphlets. 31-3/4 in. W x 5 in. D. Mounting hardware included.  
**SAF 4133SL** (135764) 15-1/4 in. H  
**SAF 4134SL** (135772) 41 in. H

**B Clear2c™ Pamphlet Display**

Break resistant polycarbonate plastic pockets. Each pocket holds 2 in. of printed material. Pre-assembled with pre-drilled holes, screws and anchors. 28 x 3 x 23-1/2 in. H. Clear.  
**SAF 5666CL** (1041318)

**C Lit-Loc® Interlocking Literature Display**

Versatile literature holders link together for a customized display. Can be linked side-by-side or vertically for multi-tiered usage. Clear plastic.  
**For leaflets - 4-3/8 x 1-1/4 x 8 in.**  
**DEF 771901** (239848)  
**For magazines - 9 x 1-1/4 x 11-1/4 in.**  
**DEF 772001** (239855)



**C** deflecto



**D** SAFCO

**D Rotating Literature Display**

Tabletop, 6 magazine compartments. 15 x 15 x 14-5/8 in. H. Crystal clear acrylic.  
**SAF 5698CL** (785196)

**E Contemporary Literature Holder**

Three clear tiered pockets for maximum literature capacity. Built-in business card holder. Free-standing, durable plastic countertop display.  
**For leaflets - 6-15/16 x 13-3/16 x 6-3/4 in.**  
**DEF 693645** (230326) silver  
**For magazines - 6-15/16 x 13-3/16 x 11-1/4 in.**  
**DEF 693745** (230334) silver  
**DEF 693704** (552307) black

**F Docuholder™ Literature Holder**

Clear. Wall or desktop.  
**For leaflets, 4 compartments - 4-7/8 x 8 x 10 in.**  
**DEF 77701** (395590)  
**For magazines, 3 compartments - 9-1/2 x 6-1/4 x 12-5/8 in.**  
**DEF 77301** (395608)



**E** deflecto



**F** deflecto

**G Euro-Style Docuholder™ Literature Holder**

Green tinted edges creating the look of a high-end glass. More durable and lightweight than glass.  
**For leaflets - 4-1/2 x 3-3/4 x 8 in.**  
**DEF 775383** (163279)  
**For magazines - 9-3/4 x 6-1/4 x 11 in.**  
**DEF 775390** (163287)

**H Literature Holder**

Single compartment. Rounded corners. To be installed on the wall or on the counter. Clear. 10 % recycled content.  
**For leaflets - 4-3/8 x 3-1/4 x 7-3/4 in.**  
**DEF 77501** (791004)  
**For magazines - 9-1/4 x 3-3/4 x 10-3/4 in.**  
**DEF 77001** (790998)



**G** deflecto



**H** deflecto



## A SHERPA® Motion Desktop Reference System

A practical and professional way to keep reference documents readily available. Each section includes 10 panel sleeves (20 viewing sides). 360-degree rotation. Reading angle adjustment to 25 and 70 degrees. Includes 10 glare-free polypropylene graphite panels, 10 snap-on tabs and rotating desk stand. Letter size.  
**DBL 5539-37** (701235)



**A** DURABLE

## B VARIO®Pro Duo Wall/Desk System

A practical and professional way to keep reference documents readily available. Can be installed on the desk or on the wall. Multi-function rotating base is designed to mix and view-adjust portrait and landscape sheets. 10-panel system displays 20 sheets. Includes 10 snap-on tabs that can be side mounted, 10 letter-size glare-free panels and desk stand/wall adapter.  
**DBL 5515-00** (758474)



**B** DURABLE

## C SHERPA®Desk Starter System

A practical and professional way to keep reference documents readily available. Starter system expand virtually without limits in 10-sleeve increments with extension module 5698. Weighted stand with non-slip rubber feet allows for two angles, 30° and 60°. Included 10 glare-free polypropylene panels, desk stand and 10 snap-on tabs. Letter size.  
**Outer frames**  
**DBL 5542-10** (666735) grey  
**DBL 5542-00** (1041417) assorted colours  
 • Extension module with 10 poly panels and snap-on tabs  
**DBL 5698-10** (314062)



**C** DURABLE

## D SHERPA® Wall Reference System

A practical and professional way to keep reference documents readily available. System has bracket angled to hold sleeves open and expands by adding multiple systems side by side. Included 10 glare-free polypropylene panels, wall bracket, mounting hardware and 10 snap-on tabs. Letter size. Grey.  
**DBL 5541-10** (666727)

## E VARIO® Wall System 10

Designed especially for facilities, with sturdy metal wall brackets to withstand heavy use. For letter size sheets which can be quickly removed or reinserted into the panel holder. Sleeves have rugged frames for durability. System includes 10 glare-free sleeves in assorted colours with 20 viewing sides and includes metal wall bracket with mounting hardware.  
**DBL 5359-00** (314070)

## F Tarifold TD271Modular Reference System

10 grey polypropylene pockets (20 sheets capacity) with a stand featuring compartments for post-it Notes, pens, cell phone, paper clips and more. White.  
**TFI TD271** (1041441)



**F**



**D** DURABLE



**E** DURABLE



**A** **RS** Royal Sovereign



**B** **RS** Royal Sovereign

**A LED Open Sign With Business Hours**

Ideal for stores, restaurants, bars, gas stations and more. 3 lighting options: ON (Open and Hours), ON (Hours only), OFF settings. Customizable business hours using stick labels. 16 x 24 in.  
**RSI RSB-1342F** (264978) French  
**RSI RSB-1342E** (265009) English

**B LED OPEN/CLOSED Sign**

Bright LED technology. Ideal for retail and service businesses, restaurants, bars and more. 4 lighting options: ON, scrolling, flashing and OFF. Visible from more than 100 ft. Easily mount with included hang chain and hooks. 11.8 x 26.3 in.  
**RSI RSB-1330E** (805771) English  
**RSI RSB-1330F** (805789) French

**C Century Series® OPEN/CLOSED Sign**

One side displays Open and the other side displays Closed. Silver on black. Sign includes suction cups. 13 x 5 in. H. English.  
**USS 4246** (1041169)



**C** **HEADLINE** SIGN



**D** **HEADLINE** SIGN

**D Century Series® Business Hours Sign**

Heavy-duty plastic construction. Includes suction cups and a complete set of 176 characters (3/4 in.). Hooks on bottom let you attach an optional Century Series. English Open/Closed Sign (sold separately). Silver on black. 13 x 14 in. H.  
**USS 4247** (1041136)

**E Open/Closed Letter Board**

Sticks to windows and doors with suction cups. Display areas on both sides. 388 letters, numbers and symbols included. Black.

**Letter board**

**USS 3727** (731240)

- Set of 258 assorted characters
- USS 3729** (1041110)

**F Reversible Sign Clock**

Clock "Will Return" on one side and "Open Come in" on the other side. 6 x 5 in.

**USS9381** (627075) English

**USS 8393** (304436) French



**E** **HEADLINE** SIGN



**F** **HEADLINE** SIGN

**G 2-Sided OPEN/CLOSED Sign**

For indoor and outdoor use. One side displays Open and the other side displays Closed.

**USS 9395** (1041102) Please Call Again

**USS9382** (1041193) Will Return

**H Business Hours Sign**

Plastic. Write-on. 8-1/2 x 11 in.

**USS9309** (608604) English

**USS 8316** (608612) French



**G** **HEADLINE** SIGN



**H** **HEADLINE** SIGN



**A EMPLOYEES ONLY Sign**

3 x 9 in. Mounting tape included.  
**USS4760** (193128) English  
**USS5848** (193250) French



**B VISITORS MUST SIGN IN Sign**

3 x 9 in. Mounting tape included.  
**USS4763** (193177) English  
**USS5852** (193268) French



**C RESTROOM Sign**

6 x 9 in. Tactile and braille characters. Mounting tape included.  
**USS5849** (112680) French  
**USS4249** (112672) English



**D WOMEN/MEN Signs**

6 x 9 in. Tactile and braille characters. Mounting tape included.  
 One of each sign per package.  
**USS 5850** (112698) French  
**USS4248** (112664) English



**E Wheelchair ACCESSIBLE Sign**

6 x 9 in. Tactile and braille characters. Mounting tape included.  
**USS 4764** (554170)



**F Wheelchair Symbol Sign**

Adhesive back. 6 x 6 in. Blue.  
**USS 9604** (563668)



**G NOTICE - SECURITY CAMERAS ARE IN USE Sign**

Self-Stick Decals. One 6 x 6 in. and two 3 x 3 in. self-stick labels.  
 Sticks to most smooth surfaces for easy application.  
**USS8198** (538181) English  
**USS 9449** (829638) French





**A** **HEADLINE**  
SIGN



**B** **HEADLINE**  
SIGN

**A Small FOR SALE Sign Kit**

Laminated carboard. 12 x 8 in. Includes a set of self-adhesive vinyl numbers.  
**USS 9398** (1041128) English  
**USS9402** (829641) French

**B Large FOR SALE Sign Kit**

Laminated carboard. 19 x 15 in. Includes a set of self-adhesive vinyl numbers.  
**USS 2317** (608588) French  
**USS 2318** (608596) French

**C FOR RENT Sign**

Corrugated plastic. 18 x 24 in. Wire stand.  
**USS 4729** (788956) English  
**USS 4895** (786004) French

**D EXIT Sign**

Glow in the dark. 8 x 12 in.  
**USS 4792** (554188) English  
**USS6251** (829640) French



**C** **HEADLINE**  
SIGN



**D** **HEADLINE**  
SIGN

**E FIRE EXTINGUISHER Sign**

Glow in the dark. 4 x 13 in.  
**USS6253** (554220) French  
**USS 4793** (554196) English

**F NO SMOKING Sign**

Vinyl sign with self-adhesive backing. 12 x 8 po.  
**USS9304** (422360) English  
**USS 8315** (829639) French

**G No smoking symbol Sign**

Vinyl sign with self-adhesive backing.  
**USS 9552** (322818) 3 x 3 in.  
**USS 9602** (38877) 6 x 6 in

**H NO SMOKING WITHIN 9 METERS Sign**

Vinyl sign with self-adhesive backing. 8 x 12 in. Bilingual.  
**USS 8369** (1041276)



**E** **HEADLINE**  
SIGN



**F** **HEADLINE**  
SIGN



**G** **HEADLINE**  
SIGN



**H** **HEADLINE**  
SIGN

## A SHERPA® Infobase Sign Stand

Letter-size crystal clear acrylic panel can be viewed from front and back. Vertical panel can be tilted +/- 14° for best display angle. Telescopic leg adjusts from 40" to 60". Stable round base. 10-5/8 x 10-5/8 x 60"H.

DBL 5589-57 (314013)



**A** DURABLE

## B Write Way® Sign Holder

Dual-sided arrow board. Magnetic dry-erase surface. Arrow tilts 45° up and down. Base can be weighted with water or sand for stability. For indoor or outdoor use. 64-1/4"H.

SAF 4173BL (773747)



**B** SAFCO

## C Double-Sided Magnetic Sign Display

Offers front and back display. Permanent, black back panel frames your messages. Sign stand holds up two letter-size inserts and features a metal post and a plastic sign. Black. 13 x 13 x 56 in. H.

DEF 692056 (1041078)



**C** deflecto

## D Double-Sided Sidewalk Chalkboard Sign

Frame with mahogany finish. Quick to set up and tear down. 20-1/2 x 31-1/4" H chalkboard surface.

QRT 6447415762 (430553)



**D** quartet

## E Wall Mount Sign Holder

Wall mountable. Literature slides in from the top. Clear.

**Landscape**

DEF 68301 (416974) 11 x 8-1/2 in.

**Portrait**

DEF 68201 (790980) 8-1/2 x 11 in.

DEF 68001 (1041086) 11 x 17 in.



**E** deflecto

## F Wall Mount Sign Holder

Wall mountable. 8-1/2 x 11 in. Literature slides in from the top or side. Clear panel for easy viewing. Black frame.

DEF 68775 (552315)

## G Wall Mount Sign Holder

Wall mountable. Accommodates up to 8-1/2 x 11 in. document.

Can be displayed vertically or horizontally. Metal knobs unscrew to easily change literature and orientation. Clear with a green tinted edge that looks like real glass.

DEF 691290 (552323)

## H Wall Mount Display Frame

Clear anti-glare plastic and satin finish aluminum frame. Hang vertically or horizontally. Mounting hardware included.

DEF 690001 (595801) 12-1/4 x 9-3/4 in.

DEF 690002 (595785) 18-1/4 x 12-1/4 in.



**F** deflecto

## I Clip Down Frame Message Holder

Post, protect and easily update your important staff notices, menus and custom messages. For indoor and outdoor use. Clip down frame design and hinged sides provide quick access to the content. Lens cover protects document from dust and dirt.

QRT 03856 (773499) 8-1/2 x 11 in.

QRT 03857 (773507) 11 x 17 in.

QRT 03859 (773515) 24 x 36 in.



**G** deflecto



**H** deflecto



**I** quartet



**A**  **DURABLE**

**A Duraframe® Security Self-Adhesive Magnetic Frame**

Dual-colored self-adhering display sign with folding magnetic front closure for all types of safety and warning information. Fully compliant with ISO-3864-4 for safety colors. Adheres to any smooth, solid surface. Works horizontally or vertically. Sturdy cover pulls back effortlessly for speedy insert updates. Magnetic seal. The sign can be read from both sides when affixed to transparent surfaces. Letter size.

- DBL 4770132** (436139) red/white
- DBL 4770130** (435628) yellow/black
- DBL 4770131** (435685) green/white

**B DURAFRAME® Magnetic Frame**

Adheres to any smooth, solid surface. Sturdy protective film pulls back effortlessly. Magnetic seal holds insert in place. Four-sided frame works vertically or horizontally. Can be read from both sides when affixed to transparent surfaces, such as glass. Package of 2.

- 8-1/2 x 5-1/2 in.**
- DBL 4913-01** (419853) black
- DBL 4913-23** (827794) silver
- 8-1/2 x 11 in.**
- DBL 4768-01** (419846) black
- DBL 4768-23** (827792) silver
- 11 x 17 in.**
- DBL 4769-01** (419861) black
- DBL 4769-23** (827793) silver

**C DURAFRAME® Magnetic Sign Holder**

Create professional looking signage/displays quickly and easily. Can be adhered and removed from metal and magnetic surfaces quickly and easily. Quick and easy exchange of information materials through fold-back, magnetic frame. Frame for letter-sized inserts can be used vertically or horizontally. 8.5 x 11 in. Package of 2.

- DBL477101** (827795) black
- DBL 477123** (827796) silver

**D DURAFRAME® Sign Holder**

Designed for fabric cubicle panels. 9-1/2 x 12 in. Sold by each.

- DBL 4969-01** (1073551) black
- DBL 4969-23** (827757) silver

**E Magnetic Label Holders**

Use with metal filing cabinets, shelving, storage cabinets and other metal surfaces. Heavy-duty magnetic back with clear front. White label inserts included. Package of 10.

- TCO 29100** (1038223) 1 x 4 in.
- TCO 29011** (1038215) 2 x 4 in.



**B**  **DURABLE**

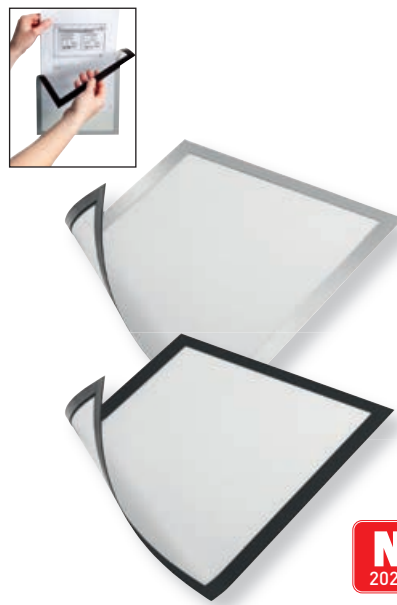

**C**  **DURABLE**

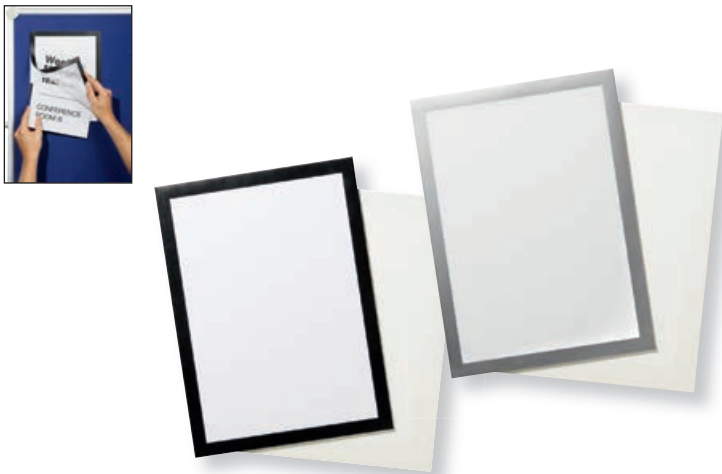

**D**  **DURABLE**



**E**





## A Stand Up Sign Holder

Allows insertion of sign from underneath. Clear.

### Portrait

DEF 69001 (393546) 4 x 6 in.

DEF 69201 (393561) 8-1/2 x 11 in.

### Landscape

DEF 69301 (796987) 11 x 8-1/2 in.



**A** 



**B** 

## B Classic Image® Slanted Sign Holder

Self-standing. Literature slides in from the side. Clear.

### Portrait

DEF69701 (405654) 8-1/2 x 11 in.

### Landscape

DEF66701 (561944) 11 x 8-1/2 in.

## C Superior Image® Swivel Sign Holder

Sides tinted green with a look of glass. Beveled edge. Reversible by removing silver knobs. Clear.

DEF 799593 (1041003) 5 x 7 in.

DEF 799693 (755603) 8-1/2 x 11 in.



**C** 



**D** 

## D Superior Image Curved Sign Holder

Clear. Sides tinted green with a look of glass. Reversible by removing silver knobs. 8-1/2 x 11 in.

DEF 799783 (755611)

## E Superior Image® Slanted Sign Holder

Permanent black border that frames your message. Clear panel.

For letter size insertion. 9-1/2 x 12-1/2 in.

DEF 69775 (796938)



**E** 



**F** 

## F Superior Image® Swivel Sign Holder

Rotate while base stays stationary. Clear. 8-1/2 x 11 in. H.

DEF 691590 (1041011)

## G Interior Image® Name Plate Holder

Features a blend of silver and black accents creating a distinctive look.

Anti-glare, protective sheet included. For tabletop, wall and cubicle.

Mounting hardware included. 8-1/2 x 2 in.

DEF 89105 (190777)



**G** 



**H** 

## H Desktop Name Holder

Clear plastic tent style name holder. Side load design.

11 x 3-5/8 x 3-1/2 in. H.

DEF 68801 (228197)

## I Desktop Name Plate Holder

Transparent acrylic 2 x 8 po.

ADK PLA28 (393462)



**I** 

## J DIY Nameplate for Desk or Wall

Create your own name plate with the user friendly website.

Follow simple instructions to choose font, logo from 8 different color combinations. Delivery will follow in 1-2 open business days. 2 x 8 in.

TRO 97468 (1043421)



**J** 

Online voucher



EXPO

# HIGH QUALITY NAME BADGE KITS & ACCESSORIES

- ✓ Choose from Magnetic, Clip, Pin, Adhesive and Hanging styles
- ✓ Holders, Inserts and Attachment Hardware Included!
- ✓ Laser and Inkjet Compatible
- ✓ Free templates available on [avery.ca](https://avery.ca)

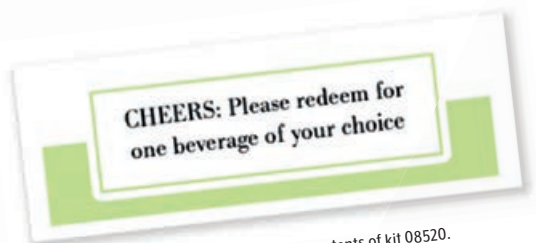

Badge and ticket depicted reflect contents of kit 08520.

## A Security Pass Holder

High quality acrylic holder for ID passes and magnetic cards. Belt clip. Passes are easily removed using the thumb slot. Vertical or horizontal. 4 x 2-3/4 in. Clear.

**DBL 8012-19** (222133) retractable cord (box 10)

**DBL 8005-19** (223685) clip (box 25)



## B Magnetic Badge Holder

Flap style transparent badge holder with magnetic clip. Will not damage clothing. Powerful magnet. Pouch style with black satin finish back. Clear rigid front part. Opening on the long side. Pre Punched sheets included. Sheets for laser and ink jet printers included. Box of 20.

**GMX225-M** (138495) 3-1/2 x 2-1/4 in.

**GMX 300-M** (598805) 3 x 4 in.



## C Vertical Style Name Badges With Lanyard

For ink jet and laser printers. 6 x 4-1/4 in. White.

### Badges and inserts

**AVE 8520** (599084) pkg 25

**AVE 8521** (1029578) pkg 75

### Inserts

**AVE 8522** (1029553) pkg 100



## D Badge Holders for Security Card

Ultra-sturdy vinyl, double thickness at the top. Back and front perforation avoiding card coming off. Can be used with different styles of fasteners. Fastener not included. Package of 50.

**GMX CW-658** (785055) vertical - 2-1/2 x 4-3/8 in.

**GMX CW-827** (785063) horizontal - 3 x 2-1/4 in.



## E Heavy-Duty Badge Holders

Prepunched holes for lanyards and clips. Secure top. 3 x 4 in. Package of 25.

**AVE 74472** (228601) vertical

**AVE 74471** (228585) horizontal



## F ID Badge Holder

Pre-punched holes for lanyards and badge clips. Heavy gauge vinyl for strength durability. 2-5/8 x 3-7/8 in. Package of 25.

**MGE 539239** (539239) vertical

**MGE539247** (539247) horizontal



## G Badges With Adhesive Strip

Easy-stick adhesive strip. Folded style in clear rigid vinyl.

Pre-punched sheets included. Box of 100.

**GMX 225-A** (598821) 3-1/2 x 2-1/4 in.

**GMX 300-A** (598813) 3 x 4 in.

## H Pocket Style Identification Badges With Clip

For ink jet and laser printers. Open top. Includes 8-1/2 x 11" sheets with detachable inserts in box of 100 only.

3-1/2 x 2-1/4 in.

**GMX 10PCL225** (679480) pkg 10

**GMX PCL-225** (488874) box 100

3 x 4 in.

**GMX PCL-300** (389999) box 100



## I Identification Badges With Clip

For ink jet and laser printers. Includes 8-1/2 x 11" sheets with detachable inserts in box of 100 only. 3-1/2 x 2-1/4".

**GMX 10-CL225** (416834) pkg 10

**GMX CL-225** (488866) box 100

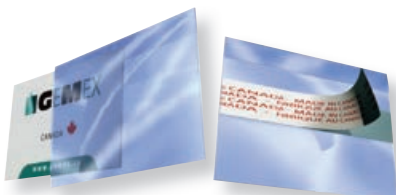



**A**  



**B**  

**A White Flexible Self-Adhesive Name Badge**

Made of flexible material that allows the label to move with clothing while still adhering securely. No PVC. Peel easily. For ink jet and laser printers. Box of 400, 50 sheets per box (8 labels per sheet). 3-3/8 x 2-1/3".

**AVE 05395** (304212) no border  
**AVE 05895** (304220) blue border

**B Clip Style Badge Holders**

For ink jet and laser printers. Durable soft plastic. PVC free. 2-1/4 x 3-1/2 in.

**AVE 74466** (1030030) pkg 24  
**AVE 74461** (228577) pkg 100  
 3 x 4 in.  
**AVE 78617** (228551) pkg 75  
**AVE 74467** (466326) pkg 24



**C** 



**D** 

**C Cord Style Name Badges**

Soft plastic. 4 x 3 in. For ink jet and laser printers. PVC free.

**AVE 74465** (115147) pkg 24  
**AVE05393** (603845) box 50

**D Identification Badge Insert Refills**

For ink jet and laser printers. 65 lb.  
**AVE 05390** (304170) 3-1/2 x 2-1/4 in. (box 400)  
**AVE 05392** (304196) 4 x 3 in. (box 300)

**E Identification Badges With Pin**

For ink jet and laser printers. The box of 100 includes 8-1/2 x 11 in. sheets of perforated inserts.

3 x 2 in.  
**GMX 200** (488841) box 100  
 3-1/2 x 2-1/4 in.  
**GMX 10-225** (416818) pkg 10  
**GMX 225** (488932) box 100  
 3 x 4 in.  
**GMX 300** (546432) box 100



**E**  



**F**  

**F Self-Adhesive Name Badges**

Sticks firmly and remove without damaging clothing. For monochromatic laser and inkjet printing or writing. 3.6 mil thickness. White. 2-11/32 x 3-3/8 in. Package of 30. FSC® certified.

**AVE 2358** (594754) red border  
**AVE 2359** (594747) blue border

**G Identification Badges With String**

For ink jet and laser printers. Box of 100 includes 8-1/2 x 11 in. sheets with detachable inserts. With pre-attached and adjustable string. 4 x 3 in.

**Package of 10**  
**GMX 10-C0300** (416842) clear  
**Box of 100**  
**GMXCO-300** (488973) clear  
**GMXCO-300B** (629824) blue  
**GMXCO-300G** (629816) green  
**GMXCO-300R** (629808) red



**G**  



**H**  

**H Identification Badge Insert Refills**

Laser or ink jet printing. Letter size. Package of 50 pre-perforated sheets.

**GMX L-225** (222398) 3-1/2 x 2-1/4 in. (pkg 400)  
**GMX L-300** (222406) 4 x 3 in. (pkg 300)

## A Retractable Badge Holder

With strong holding clip, retractable 24 in. cord, badge fastener and metal plate for engraving. Box of 25.  
**GBC05125** (736777) black  
**GBC 50573** (127969) grey



## B BadgeMates Carabiner Badge Reel

Carabiner ring, Press fastener. Retractable 36 in. nylon cord. Package of 10. Grey.  
**GBC 3381604752** (281600)



## C Retractable Badge Holder

Stainless steel reel. Plastic snap and belt clip. 30" retractable cord. Package of 12.  
**AVE 74711** (228627)



## D Retractable Badge Holder

Plastic snap and belt clip. Retractable 24 in. cord. Package of 25.  
**MGE 1008759200** (525667)



## E Retractable Badge Reel

Badge reel attaches to top-slotted badge pockets with a loop fastener and to clothing or belts with a metal clip. 1-3/16 in. diameter. 23 in. reach. Box of 10. Charcoal.  
**DBL 8152-58** (280164)



## F Retractable Badge Holder

Stainless steel reel. Plastic snap and belt clip. Retractable 28-1/2 in. cord. Sold by each. Chrome.  
**WNN 35002** (138545)



## G Retractable Badge Holder

Nickel plated badge reel. Retractable 20 in. wire. Spring belt clip. Plastic fastener with metal snap and split key ring. Sold by each.  
**MGE NPRSMALL** (535351)

## H Handi-Klip Carabiner

Carabiner clip for attaching keys and ID tags to purses, backpacks, bags, belts etc. Package of 2. Assorted colours.  
**MGE 1008410100** (1030246)

## I Badge Clip

Mylar. With clip. Package of 100.  
**MGE 1008310200** (1029602)





**A** GEMEX



**A Lanyard With Plastic Clip**

Adjustable lanyard breaks away at the neck for safety. Convenient breakaway clip to remove attachments from lanyard. Includes removable metal key ring, badge clasp and USB holder. 17-1/2 in. Sold by each.

- GMX 1119-GBK** (576223) black
- GMX 1119-GB** (576215) blue
- GMX 1119-GR** (576207) red



**B** GEMEX

**B Safety Lanyard**

Breakaway security clip lanyard with metal swivel hook. Package of 12.

- GMX 37534-12B** (598854) blue
- GMX 37534-12R** (598847) red
- GMX 37534-12BK** (598839) black

**C Lanyard With Plastic Clip**

17.5 in. adjustable lanyard breaks away at the neck for safety. Convenient breakaway clip to remove attachments from lanyard. Removable metal key ring, badge clasp and USB holder. Sold by each. Black. **MGE 1009302020** (547885)



**C** MERANGUE



**D Textile Lanyard With Safety Release**

3/8 in. wide black textile lanyard with 17 in loop. Plastic clip fastener. Safety release fastener opens if necklace becomes trapped or caught. Box of 10. Black.

- DBL 8119-01** (280156)



**D** DURABLE

**E Breakaway Lanyard**

Nylon. Metal clip. With swivel hook. 34". Package of 12. **GBC 3381605115** (736769)

**F Badgemates Badge Lanyard**

21 in. nylon lanyard with swivel clip. Black. Package of 12. **GBC 05118** (521443)

**G Neck Hanging Lanyard for Badge**

With swivel hook. 35-1/2" long. Package of 12. Black. **AVE 74710** (228619)



**E** GBC



**F** GBC



**H Identification Wristband**

Perfect for admissions and readmissions. Waterproof. Single use. Sequentially numbered bracelet. Adhesive backing, to peel. Made with DuPont™ Tyvek®. 3/4 x 10". Box of 100.

- GMX1075-WY** (576173) yellow
- GMX 1075-WB** (576199) blue
- GMX 1075-WR** (576181) red



**G** AVERY



**H** GEMEX

## A Admission Tickets

Tickets with coupon.

Roll of 1,000 tickets, double.

**BLI DA1CF-RD** (273219) red

**BLI DA1CF-BL** (273227) blue

**BLI DA-1CE-AS** (265090) assorted

Roll of 2,000 tickets, double.

**BLI DA-2CF-RD** (273052) red Bilingual

**BLI DA-2CF-BL** (273128) blue

**BLIDA-2CE-AS** (1043207) assorted



## B Tickets with Tear-Away Stubs

Uncoated 65lb cardstock. Smooth edges. Printable on both sides.

Compatible with laser and inkjet printers. 1-3/4 x 5-1/2", 10 per sheet, 200 per package. Matte White.

**AVE 16154** (571216)



## C Coat Check Tickets

Variably numbered from 1 to 500. 3 perforated sections. One section has single hole punched for attaching to hangers. Pack of 100.

**MGE 10243021** (547935)

## D Ticket Dispenser with Stand

**EGD DB-50** (805623)

• Ticket refill - 5 rolls of 2000

**EGD RT2C-DB505** (805631)



## E Suggestion Box

Steel. Lockable. 4-3/4 x 1/8" slot. Includes 25 suggestion cards, 2 keys, and front panel adhesive labels. Can be set on table or mounted to wall (hardware included). Black. 7 x 6 x 8-1/2"H.

**SAF 4232BL** (785147)

• Suggestion card refill - package of 25

**SAF 4231** (1043165)



## F Draw Box

Acrylic. Includes sign holder to customize your own message. 8" x 14-3/4" insert size. Great for raffle tickets, entry forms, bills. Back panel slides out to access contents. 4 in. drop slot size. 8-3/8 x 8-5/16 x 15H in. Clear.

**DEF 66001** (613083)

## G Coin Box

Clear acrylic. Features a top loading 4 x 6" sign holder. 3-1/2" slot. With lock. 6-1/8 x 4-3/8 x 8-1/8"H.

**DEF 596901** (715326)

## H Counter Call Bell

Loud, clear tone is easily heard throughout the room. 3 in diameter. Brushed nickel finish.

**ACM 55008** (627125)

## I 4-number Tally Counter

Hand held with 4-figure display and automatic reset knob. Chrome-plated.

**SPR 24200** (1043264) with base

**SPR 24100** (1043272) with finger ring





**A** AVERY DENNISON



**B** AVERY DENNISON

**A Monarch 1130-01 Labelling Gun**

Print 1 line of 6 characters.  
**MNK 1130-01** (115196)

**B Monarch 1131-01 Labelling Gun**

Print 1 line of 8 characters.  
**MNK 1131-01** (115519)

**C Monarch 1136-01 Labelling Gun**

Print 2 line of 8 characters.  
**MNK 1136-01** (115204)

**D Mighty-One™ Labelling Gun**

Prints 8 characters on one line. Print display window.  
**MNK H09146** (47931)

**E Dennison® 216™ Label Gun**

Reliable two line, 8 character band. Efficiently marks items and is easy to load and use. Uses 18mm x 11mm (5/8" x 21/32") labels.  
**MNK H06396** (38273)



**C** AVERY DENNISON



**D** AVERY DENNISON

**F Dennison® 106™ Label Gun**

Prints 1 line of 5-6 characters.  
**MNK H06241** (38315)

**G Swiftacher® Mark III Tag Fastener Gun**

Ergonomic design featuring a smaller grip. Smoother-moving internal mechanism.

**MNK 954885** (828479)

• **Needles - package of 4**

**MNK 954886** (828484)

• **Nylon ties - package of 1000**

**MNK 955106** (828481) 1 in.

**MNK 000994** (828480) 3 in.

• **Loop ties - package of 5000**

**MNK 000938** (355057)

• **White tags - package of 1000**

**MNK 000135NS** (808790)



**E** AVERY DENNISON



**F** AVERY DENNISON

**H Ink Rollers for 1131 and 1136 Monarch Labellers**

For Monarch 1130, 1131 and 1136. Black.  
**MNK 11828001** (595983)



**G** AVERY DENNISON





**H** AVERY DENNISON



# Pricing Gun Labels | Retail Business and Event Supplies

**A**  **1130 Fastening Gun Labels**  
**Permanent**  
 MNK 000202 (115543) white  
 MNK000205 (115550) red fluo

**B**  **1131 Fastening Gun Labels**  
**Permanent**  
 MNK 000239 (115220) white  
 MNK000240 (115535) red fluo  
**Removable**  
 MNK 000036 (115246) white

**C**  **1136 Fastening Gun Labels**  
**Permanent**  
 MNK 000305 (115527) white  
 MNK000320 (115212) red fluo  
**Removable**  
 MNK 000037 (115238) white

**D**  **Mighty-One™ Labelling Gun Labels**  
**Permanent**  
 MNK T09140 (421495) white  
 MNK T09141A (479329) red fluo  
**Removable**  
 MNK T92060 (421461) white  
 • Ink roller  
 MNK H89891 (38323)

**E**  **Labels for 216™ Fastening Gun**  
**Permanent**  
 MNK T06278 (334300) white  
 MNK T06281 (334953) red fluo  
**Removable**  
 MNK T06277 (334391) white  
 MNK T92029 (808782)  
 • Ink roller  
 MNK H89892 (38265)

**F**  **106 Labelling Gun Labels**  
**Permanent**  
 MNK T06203 (335026) white  
 MNK T06206 (335844) red fluo  
**Removable**  
 MNK T06204 (335851) white

**G**  **Pricemarker Labels**  
 MNK 000542 (808808)

	Manufacturer #	Type	Qty per Roll/Sheet	Rolls/Sheets per box	Ink Roller	Colour
<b>FOR MONARCH 1130-01</b>						
A	000202	Permanent	2500	10	included	white
A	000205	Permanent	2500	10	included	fluorescent red
<b>FOR MONARCH 1131-01</b>						
B	000239	Permanent	2500	8	included	white
B	000240	Permanent	2500	8	included	fluorescent red
B	000036	Removable	2500	8	included	white
<b>FOR MONARCH 1136-01</b>						
C	000305	Permanent	1750	8	included	white
C	000320	Permanent	1750	8	included	fluorescent red
C	000037	Removable	1750	8	included	white
<b>FOR MIGHTY-ONE™</b>						
D	T09140	Permanent	1500	28	not included	white
D	T09141A	Permanent	1500	28	not included	fluorescent red
D	T92060	Removable	1500	28	not included	white
D	H89891	Ink Roller	n/a	5		
<b>FOR DENNISON® 216™</b>						
E	T06278	Permanent	1250	40	not included	white
E	T06281	Permanent	1250	40	not included	fluorescent red
E	T06277	Removable	1250	40	not included	white
E	T92029	Removable	1250	10	not included	fluorescent red
E	H89892	Ink Roller	n/a	5		
<b>FOR DENNISON® 106™</b>						
F	T06203	Permanent	1000	54	not included	white
F	T06206	Permanent	1000	54	not included	fluorescent red
F	T06204	Removable	1000	54	not included	white
<b>FOR MONARCH 1105/1110</b>						
G	000542	Permanent	1063	16	not included	white



# Wellbeing

Workers want the peace of mind in knowing they are prioritized above all else. In this section you will find everything to create safe and healthy working conditions for yourself and your colleagues.

# BREAKROOM AND FACILITIES MANAGEMENT

## BREAKROOM

Coffee Brewers and Kettles .....	290
Small Appliances .....	292
Hot Beverages .....	294
Beverage Condiments .....	299
Cold Beverages .....	300
Candies and Snacks .....	302
Carafes and Cups .....	306
Food Service Supplies .....	309
Napkins and Tablecloths .....	314

## HEALTH AND SAFETY

Hand Protection .....	316
Eye Protection .....	318
Respiratory Protection .....	319
Protective Clothing .....	320
Hearing Protection .....	322
Safety Equipment .....	323
First Aid Kits .....	325
First Aid Supplies .....	327



## JANITORIAL MAINTENANCE AND SUPPLIES

Personal Care Products .....	332
Hand Soap and Dispensers .....	334
Hand Disinfectant and Dispensers .....	337
Facial Tissue .....	340
Paper Towels and Dispensers .....	341
Toilet Tissue and Dispensers .....	346
Washroom Supplies .....	349
Odour Control .....	350
Air Quality .....	353
Cleaners and Disinfectants .....	355
Cleaning Supplies .....	365
Maintenance Equipment .....	367
Brooms and Vacuums .....	368
Floor Mops .....	371
Waste Management .....	375
Floor Mats .....	382

## MAILROOM AND HANDLING

Envelopes .....	384
Envelope Accessories .....	395
Shipping Boxes .....	396
Packaging Tape and Dispensers .....	397
Shipping Supplies .....	399
Postal Scales .....	403
Mailroom Equipment .....	404



**A** Hamilton Beach®



**B** KEURIG

**A C40515 42-Cup Coffee Urn**

1 minute per cup brewing time. Ready-to-serve light, twist-lock lid and removable cord. Makes 12 to 42 cups.  
**HMB 40515CR** (266288)

**B K1500 Small Business Brewing System**

Quiet Brew™ technology minimizes noise during use. Strong brew feature for a bolder flavoured coffee. 96 oz reservoir brews 12 cups. 10.25 x 12 x 12.35 in.  
**KEU 50-38114** (584342)

**C BrewStation® 12 Cup Coffeemaker**

Removable water reservoir makes filling easy. Programmable digital clock. Adjustable automatic shut-off from 0 to 4 hours. Press bar to dispense one fresh cup at-a-time. Programmable for iced coffee. Black.  
**HMB 47950** (829384)  
 • 4 cup carafe  
**HMB 88087C** (829667)

**D Stainless Steel Coffee Dispenser**

Up to a cup-per-minute brewing speed. Cup trip handle. External water window. Twist-lock lid. 60 cups.  
**HMB D50065C** (829660)

**E Proctor Silex Coffee Dispenser**

Twist-lock lid for safety and better heat retention. Cup-a-minute brewing speeds. Detachable power cord. 100-cup capacity. 1-year limited warranty.  
**HMB 45100CR** (829662)



**C**



Find Coffee on **pages 294-297**



**D** Hamilton Beach®



**E** Hamilton Beach®

## A 12 Cup Coffeemaker

Removable, dishwasher-safe filter basket. Automatic pause and serve.  
**PSX 43804** (829664) black  
**PSX43801** (829669) white

## B 12 Cup Programmable Coffeemaker

Easy to read programmable LCD clock with 2 hour automatic shutoff.  
 Black.  
**PSX 43874** (829668)

## C Coffee Filters

**Basket type**  
**MLA 62940** (728923) pkg 100  
**BUN 201156000** (728782) pkg 1000  
**No 4, cone shape.**  
**MLA 62454** (794073) box 40



**A** **Proctor+Silex**

## D 1L Cordless Kettle

Cordless base for kettle portability. Immersed heating element.  
 Auto shut-off. Boil-dry protection. On/off indicator light. White.  
**PSX 41005** (587022)

## E 1.7 Liter Electric Kettle

1,500 watts. Cordless kettle lifts off base for cordless pouring.  
 Auto shut-off with boil-dry protection. Dual water level windows.  
 Lighted on/off switch with auto shutoff when water boils. Black.  
**PSX 41008PS** (829661)

## F 1.7 Liter Electric Kettle

1,500 Watts. Cordless kettle lifts off base for cordless pouring.  
 Auto shut-off with boil-dry protection. Dual water level windows.  
 Lighted on/off switch with auto shutoff when water boils. White.  
**PSX K4090PS** (829665)

## G 1 Liter Electric Kettle

1,500 Watts. 360° cordless base. Auto shut-off with boil-dry protection.  
 Concealed heating element. Water level window. Pop-up lid with button  
 release on handle. Illuminated on/off switch. Removable mesh filter.  
 5-yr limited warranty. Stainless steel.  
**HMB 40998C** (829674)



**B** **Hamilton Beach**



**C**



**D** **Proctor+Silex**



**E** **Proctor+Silex**



**F** **Proctor+Silex**



**G** **Hamilton Beach**



**A** RS Royal Sovereign



**B** RS Royal Sovereign

**A RWD-50B Countertop Water Dispenser**

Convenient hands free paddle design dispenses room temperature water. No installation, no electricity and no plumbing required. Convenient Top Load Design. Use with 3 and 5 gallon bottles. Black. **RSI RWD-50B** (829475)

**B RWD-700W Water Dispenser**

Compressor cooling dispenses hot and cold water. No installation and no plumbing required. Stainless steel water tank. Uses 3 and 5 gallon bottles. White. **RSI RWD-700W** (829476)

**C RWD-1750S Tri-Temperature Water Dispenser**

Dispenses boiling hot, room and cold water. Bottled water is stored at the bottom of unit. Bottle top snaps on bottle for quick and easy operation. Low bottle indicator light. Uses 3 and 5 gallon bottles. Black/silver. **RSI RWD-1750S** (829477)



**C** RS Royal Sovereign



**D** GENUINE JOE

**D Dual Temperature Water Cooler**

Top loading water cooler dispenses water in both hot and cold settings. Provides a hot water capacity of 5 litres and a cold water capacity of 1 litre. Bottom cabinet with adjustable shelf. Removable drip tray. 12-1/2 x 13-3/8 x 39-1/4 in. Black. **GJO 22554** (1064344)

**E RMF-70 Compact Refrigerator**

Reversible door with recessed handle. Adjustable thermostat. 2 glass shelves. 2L bottle rack. Can storage dispenser. Freezer compartment. 2.6 cu. ft. 17.5 x 19.3 x 25 in. White. **RSI RMF-70W** (191601)

**F RMF-113 Compact Refrigerator**

Reversible door with recessed handle. Adjustable thermostat. 2 glass shelves. 2 L bottle rack. Can storage dispenser. Freezer compartment. 4 cu. ft. 19 x 22.8 x 33.4 in. **RSIRMF-113SS** (191619) stainless steel **RSI RMF-113B** (526731) black



**E** RS Royal Sovereign



**F** RS Royal Sovereign

**G Compact Refrigerator**

Reversible door, flush back and leveling legs for easy fit into tight areas. Full-range thermo dial control lets you easily adjust temperature. Includes chiller section with ice cube tray, 4 shelves and more. 1-year warranty. 3.3 cu.ft. **LLR72313** (1065169) black **LLR 72312** (1065177) white

**H Beverage Cooler**

Features electronic controls to precisely store and keep your beverages chilled. Blue LED light in the interior illuminates beverages. Three glass shelves are adjustable to accommodate various bottle sizes. 4.5 cu. ft capacity. **RSI RMFBC128SS** (1073345)



**G** LORELL



**H** RS Royal Sovereign

**A RCMW-100025SS Commercial Microwave Oven**

Stainless steel interior and exterior. 1000 W. Ceramic bottom without turntable. Ideal for light and medium use such as in quick service snack bars, supermarkets, delis and convenience stores, office cafeterias, staff breakrooms, etc. Features multi-storage cooking with 3 power levels. 10 programmable settings. 0.9 cu. ft.  
**RSI RCMW100025** (327346)



**A** **RS** Royal Sovereign



**B** **RS** Royal Sovereign

**B RMW25-900W Microwave Oven**

900W power output. LED timer/clock. 10 power levels with 6 express cooking options. Speed and weight defrost. Child safety lockout. 0.9 Cu.ft. 19 x 13.6 x 10.75 in. White.  
**RSI RMW25-900W** (829471)

**C RMW30-1000W Microwave Oven**

1000W power output. LED timer/clock. 10 power levels with 6 express cooking options. Speed and weight defrost. Child safety lockout. 1.1 Cu.ft. 20.2 x 15.2 x 11 in.  
**RSI RMW301000W** (829472) white  
**RSI 829473** (829473) stainless steel



**C** **RS** Royal Sovereign

**D Toaster**

Wide slots for bagels. Easy retrieval of smaller slices with toast boost. Slide-out crumb tray. Cancel button and 7 shade selector.  
**PSX 22216PS** (829388) 2-slice - white  
**PSX 24215PS** (829671) 4-slice - black

**E Toaster**

4-slice. Wide slots for bagels. Soft touch controls, defrost and cancel functions. Slide-out crumb tray. Toast shade control with 5 settings. Auto shut-off safety feature. 5-year limited warranty. Chrome.  
**HMB 24791C** (829663)

**F Easy-Reach™ Convection Oven**

Toast, bake and broil settings. Fits 9 x 11 in. bake pan; 12 in. pizza or 6 slices of toast. 30-minute timer with optional stay-on. Includes bake pan and 2-position broil rack. Removable crumb tray. 5-year limited warranty. Black and chrome.  
**HMB 31126C** (829670)



**D** **Proctor-Silex**

**G Panini Press Sandwich Maker**

Grills sandwiches of any thickness. 10 x 8 in. non-stick grids. Power and preheat lights. Upright storage. 5-year limited warranty. Chrome and black.  
**HMB 245460C** (829675)



**E** **Hamilton Beach**

**F** **Hamilton Beach**



**G** **Hamilton Beach**

**KEURIG** For Keurig brewers



**A**



**B**



**C**



**D**



**E**



**F**



**G**



**H**



**I**



**J**



**K**



**L**



**M**

**A Adagio Coffee**

Napoli Caffè. Box of 24.  
KEU 86-27924 (539171)

**B Barista Prima™ Coffee**

Box of 24.  
KEU77-35017 (295196) French Roast  
KEU 77-40017 (295212) Colombia  
KEU 89-60863 (295220) Italian Roast

**C Cake Boss Coffee**

Box of 24.  
ECZ KCAKEBUDDY (1005199) Buddy's Blend™  
ECZ KCAKEVANBU (1005207)  
Vanilla Buttercream

**D Authentic Donut Shop Coffee**

Box of 24.  
ECZ KDSORIDAR (1005280) Original Dark  
KEU56-07722 (539189) Regular  
ECZ KDSORIMED (1005298) Original Roast  
ECZ KDSVANHAZ (1005306) Vanilla Hazelnut

**E Emeril's Big Easy Bold® Coffee**

Box of 24.  
KEU 97-01936 (554626)

**F Folgers™ Coffee**

Box of 24.  
KEU 61-22709 (353888) Lively Colombian  
KEU61-22711 (1005322) caramel drizzle  
KEU 61-22714 (554543) vanilla biscotti  
KEU61-20902 (1005330)  
Classic Roast

**G Green Mountain® Coffee**

Dark Magic. Box of 24.  
KEU 94-04761 (1005348)

**H Grove Square™ Coffee**

Box of 24  
ECZKGRSQCAPFR (510230) French vanilla  
ECZ KGRSQCAPPC (1005356) caramel  
VND14M119CHA (832851) hazelnut  
Box of 44  
VND14M1134 (832856) French vanilla

**I The JetSetter Coffee Co. Coffee**

Box of 24.  
ECZ KJETAL024 (1005257) Aloha  
ECZ KJETBRE24 (1005405) Breakfast on board  
ECZ KJETRED24 (1005264) The Red Eye  
ECZ KJETVANB24 (1005272) Vanilla Bean There

**J Timothy's Kahlua Coffee**

Box of 24.  
KEU 97-01341 (1005413)

**K Lavazza® Classico Coffee**

Box of 24.  
KEU 63-54024 (353896) Classico

**L Marley Coffee**

Box of 24.  
MRP MARLIVUP24 (1005496) Lively Up  
MRP BUFFALO24 (1073196) Buffalo Soldier  
MRP ONELOVE24 (1005504) One Love

**M Martinson™ Coffee**

Box of 24.  
MRP KMARBRE24 (509927) breakfast blend  
MRP KMARDAR24 (509935) dark roast  
MRPCOLDECAF24 (509943) columbian decaffeinated  
MRPKMARKHOU24 (509950) medium house blend  
MRPKMARKONA (509968) Kona



**KEURIG** For Keurig brewers

**A Maxwell House Coffee**

Box of 12.  
VND 11KR185 (1005439)



A

**B McCafé® Premium Roast**

Box of 24.  
VND 829345 (829345)



B

**C Paradiso® Coffee**

Box of 24.  
MRP KSECPARMED (509893) medium roast  
MRPSECPARDARK (509901) dark roast



C

**D Starbucks® Coffee**

Box of 24.  
VND 11ST201PIK (272419) Pike Place Roast  
VND 11ST194 (272427) Decaf Pike Place Roast  
VND11ST201TRU (1005554) True North Blend  
VND 11ST201VER (341438) Verona\*  
VND 11ST201FRR (547745) French roast  
VND11ST201SUM (832840) sumatra



D

**E Tim Hortons® Coffee**

Box of 24.  
KEU 61-01306 (580076) original blend  
KEU 61-01308 (587014) decaf  
KEU 61-01307 (584771) dark roast  
KEU 61-11309 (586974) Colombian  
KEU 61-11311 (586990) French vanilla



E

**F Timothy's™ Coffee**

Box of 24.  
KEU 96-06777 (196956) Colombian La Vereda  
KEU96-06775 (341370) Decaffeinated Colombian  
KEU 96-06766 (341354) Rainforest Espresso  
KEU 96-06767 (341529) German Chocolate Cake  
KEU 96-06771 (341362) Breakfast Blend  
KEU 96-06772 (1005710) Parisian Nights  
KEU 96-06776 (539155) Colombian Excelencia  
KEU 96-06779 (341511) French Vanilla  
KEU 96-06782 (341420) Original Donut  
KEU 96-06784 (1005702) Hazelnut  
KEU 96-06785 (341404) Magic Night  
KEU 96-06792 (272393) Italian Blend



F

**G Tully's Italian Roast Coffee**

Box of 24.  
KEU 94-20788 (1005736)



G

**H Van Houtte® Coffee**

Box of 24.  
KEU 40-77917 (272468) French roast  
KEU 40-19917 (272328) breakfast blend  
KEU 40-53917 (539122) French vanilla  
KEU 80-62917 (341545) Swiss Water Process Decaf, Fair Trade  
KEU80-97917 (341503) Costa Rica, light  
KEU80-51517 (341586) Mexico Fair Trade Organic  
KEU80-89817 (539163) sumatra  
KEU 40-59918 (272476) house blend medium  
KEU 40-54917 (539114) decaffeinated house blend  
KEU 40-09918 (272260) dark Colombian  
KEU 40-33918 (272336) medium Colombian  
KEU 40-80817 (585620) house blend dark  
KEU 40-39917 (272344) vanilla hazelnut



H

**I Wolfgang Puck Coffee**

Box of 24.  
MRP KWPHAZ24 (1005389) hawaiian hazelnut  
MRP JAMAICA24 (1005397) Jamaican Me Crazy  
MRP KWPGOBOLD (1005512) Go Bold  
MRP KWPRODEO24 (1005538) Rodeo Drive  
MRP PVANFRETOA (1005520) Vanilla-French Toast  
MRPBRKINBED24 (509919) Breakfast Blend



I



**A**

**A Tassimo Coffee Pods**

- Nabob cappuccino - package of 8  
VND14KR113 (1005611)
- Nabob - package of 14  
VND 11KR150 (1005579) Columbian
- VND 11KR151 (1005462) Cafe Crema
- VND 11KR152 (1005603) Breakfast
- VND 11KR164 (1073204) espresso
- VND 11KR170 (1005587) Swiss Hazelnut
- Carte Noire - package of 14  
VND 11KR159 (1073212) Americano
- Maxwell House - package of 14  
VND 98784 (51701) original bland
- VND 11KR165 (1005561) decaffeinated
- McCafé - package of 14  
VND 310 (504613)



**B**

**B Grove Square™ Hot Chocolate**

- For K-cup brewer. Box of 24.  
ECZ KGRSQHOTCH (510222)



**C**

**C Laura Secord® Hot Chocolate Mix**

- For K-cup brewer. Box of 24.  
KEU 77-21917 (353953)



**D**

**D Bigelow® Tea**

- For K-cup brewer. Box of 24.  
KEU 81-06717 (272435)



**E**

**E Higgins & Burke Tea**

- For K-cup brewer. Box of 24.  
MRPHLLTAME24 (1005371) green tea
- HBT 3028813 (509851) Bergamia Grey
- HBT 3029041 (509885) orange pekoe



**F**

**F Grove Square™ Tea**

- For K-cup brewer. Box of 24.  
VND 14M1131 (832854) chai latte
- VND14M1133SPD (832855) Apple cider spice



**G**

**G Tetley® Tea**

- For K-cup brewer. Box of 24.  
KEU 81-06817 (585604) orange pekoe
- KEU 81-12817 (585588) peppermint
- KEU 81-17817 (585596) green tea



**H**

**H Timothy's® Tea**

- For K-cup brewer. Box of 24.  
KEU 77-10517 (554568) chai latte



**I**

**I Twinings Tea**

- For K-cup brewer. Box of 24.  
VND 15M126EAR (832862) Earl Grey
- VND 15M126CHA (832861) chai
- VND 15M126BDC (832863) English breakfast decaf
- VND 15M126IRI (832866) Irish breakfast
- VND 15M126ENG (832864) English breakfast
- VND 15M126GRN (832865) green tea

**A Starbucks® Coffee**

Pike Place® Roast.  
**VND 11018197** (290569) 70 g (box 18)  
**VND 11S181PIK** (832836) 1 lb (box 6)



**A**

**B Club Coffee™ Coffee**

100% Colombian, Batch 82. 57 g pouch. Box of 42.  
**VND 308239** (308239)



**B**

**C Timothy's® Coffee**

70 g pouch. Box of 24.  
**KEU 5000320051** (370874) breakfast blend  
**KEU 5000320743** (370882) Colombian la vereda  
**KEU 5000321186** (370890) Italian blend



**C**

**D Mother Parkers Coffee**

39 g packets. Box of 42.  
**MRP 1103421** (509984) Mountain Grown  
**MRP MPCOLOM** (509992) 100% Colombian

**E McCafé Premium**

950 g canister. Sold by each.  
**VND 128136** (596478)

**F Maxwell House® Coffee**

Original roast. Medium-light. 925 g can. Sold by each.  
**VND 11KR200** (784207) 1 canister  
**KRF GEN86635** (1064253) 42 packets

**G Mother Parkers Original Roast Ground Coffee**

925 grams. Sold by each.  
**MRP 11MP225** (827862)

**H Good Host Coffee**

100% Colombian. 1.75 oz. packets. Box of 42.  
**VND 11CL331** (832833)

**I DURE French Vanilla Cappuccino**

907g packet. Box of 6  
**VND 14DU100FRV** (832847)  
 • Paquet of cappuccino foamer  
**VND 14MI122** (832853)



**D**



**E**

**J Folgers Instant Coffee**

Classic roast. 8 oz.  
**FOL 2550020641** (1004829)



**F**



**G**



**H**



**I**



**J**



**A**



**B**

**A Orange Pekoe Tea**

Box of 240.  
TAT 15TE100 (308460)

**B Black Tea**

Individually wrapped tea bags. Box of 100.  
LIP TJL00291 (1065482)

**C Orange Pekoe Tea**

Individually wrapped. Box of 100.  
MRP TEAORAN100 (1004944)

**D Higgins & Burke Tea**

Box of 20.  
HBT 3030371 (510032) Earl Grey  
HBT 517037 (517037) orange pekoe  
HBT 3030377 (510040) green tea  
HBT 3030389 (510057) peppermint  
MRP HBENGBRK (1005041) English Breakfast  
MRP HBTREELEM (1005033) Lemon



**C**



**D**

**E Tetley Tea**

Box of 25.  
TAT 571711 (571711) orange pekoe decaffeinated  
TAT 517045 (517045) Chai  
ECZ TETEARL25 (1005090) Earl Grey  
ECZ TETCHA25 (1005082) Pure Camomile  
ECZ TETENGR25 (1005132) English Breakfast  
ECZ TETGREEN25 (1005116) Green Tea  
ECZ TETPEPP25 (1005124) Peppermint  
ECZ TETWILD25 (1005108) Wildberries

**F Bigelow Green Tea**

Box of 28.  
VND 15BG106JAP (832857)

**G Tazo Tea**

Box of 24.  
VND 15L1137CHA (832859) organic chai  
VND 15L1137REF (832860) refresh mint

**H Dure-Licious Hot Chocolate Mix**

907 g.  
VND 13DU100 (832843)

**I Dove Hot Chocolate**

For Flavia brewer. Box of 18.  
VND 13FL103 (832844)  
• Real milk froth powder (box of 72)  
VND 14FL104 (832849)

**J Carnation Signle-Serve Hot Chocolate**

Box of 50 packets.  
VND 13NE116 (832845) 19 g packet  
VND 13NE117 (832846) 25 g packet



**E**



**F**



**G**



**H**



**I**



**J**



**A White Sugar**

20 oz canister (570 g)  
**VND 18DU101** (308270)  
 Box of 1000 3.5g packs  
**RPG 407256** (786111)



**A**

**B Sugar Packs**

Box of 1000.  
**VND 18M1102** (832871)



**B**



**C Sugar In The Raw**

Distinctive sweet taste comes from naturally occurring molasses.  
 500 g. Sold by each.  
**ECZ RAWCANISTR** (1004860)



**C**

**D Granulated Brown Sugar**

3.5 g. Box of 1000 packs.  
**FOD 02061** (182162)



**D**



**E Sugar Twin® Sweetener**

Calorie free. Box of 1000 packs.  
**FOD 80597183** (169722)



**E**

**F Artificial Sweetener**

Sucralose. Dispenser box of 400 packs.  
**GJO 70468** (1065391)



**F**

**G Coffee-Mate® Whitener**

Lactose and sodium free. Original flavour.  
 311g powder  
**NES 11001016** (302364)  
 11 ml serving - box of 180  
**NES 12109163** (302331)



**G**

**H Mother Parkers Coffee Whitener**

Powder. 450 g.  
**MRP 3456586** (222182)



**H**

**I Grand Pré 2% Milk**

High-quality milk made from 100% cow's milk. Extended shelf life. 1L.  
 Box of 12.  
**VND 22M1115** (832872)



**I**



**A**



**B**



**A Nestlé® Spring Water**

Recyclable water bottle. 500 ml. Box of 24 bottles.  
**UNS 225356** (110700)

**B Eska® Natural Spring Water**

Free of sodium and metals. 500 ml. Box of 24 bottles.  
**FOD 155226** (155226)

**C Perrier® Spring Water**

Natural carbonated water. 330ml. Box of 24.  
**VND 01NE1114X3** (243360)

**D San Pellegrino Mineral Water**

Natural carbonated mineral water. 250 ml. Box of 24. (4 packages of 6).  
**NLE 96384** (549402)

**E Glaceau VitaminWater Drinks**

Nutrient-enhanced beverage combines distilled water with vitamins and herbs. 591 ml. Box of 12 bottles. Acai blueberry pomegranate.  
**VND 01C0245XXX** (1019694)

**F Minute Maid Juice**

Made from concentrate. 341ml. Box of 24.  
**VND 01C0119MMA** (832705) apple juice  
**VND 01C0119MMO** (832706) orange juice

**G Oasis Juice**

100% juice. 300ml. Box of 24.  
**VND 01EF114APL** (832708) apple  
**VND01EF114CRA** (832709) cranberry apple  
**VND 01EF114ORG** (832711) orange  
**VND01EF114RED** (832712) ruby red grapefruit

**H Minute Maid Juice**

From concentrate, with added Vitamin C. 200ml. Box of 32.  
**VND 01MI212APL** (832713) apple  
**VND 01MI212ORG** (832714) orange



**C**



**D**



**E**



**F**



**G**



**H**



## A Carbonated Soft Drinks

Box of 12 cans

VND01C0173 (1019637) Canada Dry Club Soda

VND01C0212 (1019744) Root Beer

VND 01PE192 (832715) Orange Crush

VND 01PE204DT (832717) Diet Pepsi

Box of 24 cans

VND 01C0107 (1019660) Canada Dry Ginger Ale

VND 01C0110 (832703) Coca Cola

VND 01C0112 (1019653) Diet Coke

VND 01C0121 (1019678) Sprite

VND 01C0189 (1019777) Coke zero sugar



## B Bubbly Sparkling Water

Natural flavours. 355ml. Box of 12.

VND01PE238APL (832718) apple

VND 01PE238BLK (832719) blackberry

VND 01PE238CHE (832720) cherry

VND 01PE238GRP (832721) grapefruit

VND 01PE238LIM (832722) lime

VND 01PE238ORG (832723) orange

VND 01PE238PEA (832724) peach

VND 01PE238PIN (832725) pineapple

VND 01PE238STR (832726) strawberry



A

## C Nestea Lemon

Natural lemon flavour. 341ml can. Box of 24.

VND 01C0120NES (832707)

## D Brisk Lemon Ice Tea

355ml can. Box of 12.

VND 01PE203 (832716)

## E Original V8

Mix of garden vegetables: tomatoes, carrots, celery, beets, parsley, lettuce, watercress, spinach. 340ml. Box of 24.

VND 01V8101 (832727)

## F V8 Low Sodium

Mix of garden vegetables: tomatoes, carrots, celery, beets, parsley, lettuce, watercress, spinach. 163ml. Box of 48.

VND 01V8109 (832728)



B



Don't see your favourite drink?  
Check out our website for more choices.

C



D



















E



F



 <p><b>A</b></p>	 <p><b>B</b></p>	 <p><b>C</b></p>	<p><b>A Life Savers 5 Flavours</b> 32 g. Box of 20. VND 07WR1135FL (832819)</p> <p><b>B Life Savers</b> 150 g. Box of 12. VND 07WR128PMI (832820) Pep-O-Mint VND 07WR128WIN (832821) Wint-O-Green</p>
 <p><b>D</b></p>	 <p><b>E</b></p>	<p><b>C Life Savers Breath Savers</b> 21g roll. Box of 12. VND 08BR103WIN (832823) wintergreen VND 08BR103PMI (832822) peppermint</p> <p><b>D Halls Lozenges</b> Box of 20. VND 08CA107 (832824) honey lemon VND 08CA108 (832825) cherry</p>	<p><b>E Excel Gum</b> Box of 12. VND 08WR133PMI (832826) peppermint VND 08WR133POL (832827) polar ice VND 08WR133SMI (832828) spearmint VND 08WR133WTR (832829) winterfresh</p>
 <p><b>F</b></p>	 <p><b>G</b></p>	 <p><b>H</b></p>	<p><b>F Excel Mints</b> 12.2 g. Package of 4. VND 08WR153 (832830)</p> <p><b>G Gummy Zone Sour Tongue Tingle</b> 120 g. Box of 24. VND 07GZ124 (832815)</p>
 <p><b>I</b></p>			<p><b>H Welch's Fruit Snacks</b> 60 g. Box of 48. VND 07MI100MXD (832816)</p> <p><b>I Werther's Original Caramels</b> Individually wrapped VND 07MI299 (832817) chewy (box 12) VND 07MI133 (1004803) rolls (box 12) VND 07MI301 (832818) hard candies (box 14)</p>
 <p><b>J</b></p>	 <p><b>K</b></p>	<p><b>J Kerrs Twist Top Candies</b> KBL80037 (829590) fruit taffy (425 g) KBL 080019 (385708) Scotch mints (500 g) KBL 080036 (362756) deluxe assortment (425 g) KBL 080038 (362764) assorted toffee (425 g) KBL 080005 (362723) fruit drops (500 g) KBL 080009 (362731) clear mints (500 g) KBL80256 (829591) spearmint mints (500 g)</p>	<p><b>K Kerr Mints</b> Package of 200 g. KBL 67021 (829595) English mints (200 g) KBL49319 (829600) Scotch mints (90 g) KBL49365 (829601) chocolate mints (80 g) KBL 67013 (829592) striped mints (200 g) KBL 67065 (829596) chocolate mints (175 g) KBL 67019 (829594) Scotch mints (200 g)</p>
 <p><b>L</b></p>	 <p><b>M</b></p>	 <p><b>N</b></p>	<p><b>L Kerrs Toffee Candies</b> KBL49308 (829599) 90 g KBL 67025 (829593) 175 g</p> <p><b>M Kerrs Soft Candies</b> Package of 123 g. KBL 25501 (829597) vanilla caramel KBL 25503 (829598) butterscotch</p> <p><b>N Kerrs Butterscotch</b> Package of 90 g. KBL 49314 (829602)</p>





Time for a  
break?

We have all  
your favourite  
snacks.



**A**

**A Nutri-Grain Cereal Bars**

37g bar. Box of 16.  
**VND 04KE100APL** (832775) apple cinnamon  
**VND04KE100BLU** (832776) blueberry  
**VND04KE100MXD** (832777) mixed berry  
**VND04KE100STR** (832778) strawberry



**B**

**B Kashi Whole Grain Bars**

35g bar. Box of 5 bars.  
**VND 04KE134HON** (832779) honey almond flax  
**VND 04KE134TRL** (832781) trail mix



**C**

**C Kashi 7 Grain with Quinoa Bars**

Chocolate chip chia. 40 g  
**VND 04KE141** (832785) box 5  
**VND 04KE138** (832782) box 36



**D**

**D Kellogg's Special K Fruit Crisps**

2 bars per pack. 25 g. Box of 12.  
**VND 04KE140BLU** (832783) blueberry  
**VND 04KE140STR** (832784) strawberry



**E**

**E Clif Bars**

68 g. Box of 12.  
**VND 04MI176CHA** (832786) chocolate almond fudge  
**VND 04MI176CHO** (832787) chocolate chip  
**VND 04MI176CRN** (832788) crunchy peanut butter  
**VND 04MI176OAT** (832789) oatmeal raisin walnut  
**VND 04MI176WHC** (832790) white chocolate macadamia nut



**F**

**F Kind Bars**

40 g. Box of 12.  
**VND 04MI190ALM** (832791) almond & coconut  
**VND 04MI190DAR** (832792) almond mint & dark chocolate  
**VND 04MI190CHO** (832793) almond dark chocolate sea salt  
**VND 04MI190CRM** (832794) caramel almond sea salt  
**VND 04MI190HNY** (832795) honey roasted nuts & sea salt  
**VND 04MI190MAP** (832796) maple glazed pecan & sea salt  
**VND 04MI190PBD** (832797) peanut butter & dark chocolate



**G**

**G Taste of Nature Snack Bar**

40 g. Box of 16.  
**VND 04MI222ALM** (832798) almond  
**VND 04MI222APL** (832799) apple  
**VND 04MI222BLU** (832800) blueberry  
**VND 04MI222BRA** (832801) Brazil nut  
**VND 04MI222CRA** (832802) cranberry



**H**

**H Munchies Peanuts**

55 g. Box of 12.  
**VND 05H0113** (832803) salted  
**VND 05H0114** (832804) honey roasted  
**VND 05H0115** (832805) barbecue  
**VND 05H0116** (832806) honey sweet



**I**

**I Blue Diamond Almonds**

23 g - box of 18  
**VND 05MI124** (832807) smokehouse  
**VND 05MI134** (832808) roasted salted  
 43 g - box of 12  
**VND 05MI223** (832809) smokehouse  
**VND 05MI226** (832810) sriracha

## A Lays Potato Chips

40 g. Box of 40.  
**VND 02H0106BBQ** (832729) barbecue  
**VND 02H0106KET** (832731) ketchup  
**VND 02H0106REG** (832732) regular



**A**

**B**



## B Lays Oven Baked Chips

32 g. Box of 40.  
**VND 02H0107** (832733) regular  
**VND 02H0155** (832739) barbecue

## C Miss Vickie's Chips

40 g. Box of 40.  
**VND 02H0108ORG** (832735) original  
**VND 02H0108JAL** (832734) jalapeno  
**VND 02H0108SMV** (832736) sea salt & vinegar



**C**

**D**



## D Plantain Chips

85 g. Box of 50.  
**VND 02MI117SLT** (832741) salted  
**VND 02MI117NAT** (832742) sweet

## E Ruffles Sour Cream 'n Onion

40 g. Box of 48.  
**VND 02H0160SCO** (832740)



**E**

**F**



## F Rold Gold Pretzels

47 g. Box of 40.  
**VND 02H0112** (832738)

## G Oreo® Cookies

22 g. Box of 100.  
**MDZ 6672100674** (426486)



**G**

**H**



## H Dad's Oatmeal Cookies

2 cookies per package. Box of 48.  
**MDZ 5683322831** (832831)

## I Rondeau Chocolate Chunks Cookies

100 g. Box of 8.  
**VND 09R0121CHO** (832832)



**I**

**J**



## J Barbecue Corn Nuts

48 g. Box of 18.  
**VND 06KR102BBQ** (832811)

## K Mini Ritz Bits Sandwiches Cheese Crackers

70 g. Box of 12.  
**VND 06KR124** (832812)



**K**

**L**



## L Jack Link's Beef Jerky

35 g. Box of 12.  
**VND 06MI242ORG** (832813) original  
**VND 06MI242TER** (832814) teriyaki

Don't see your favourite snack?  
 Check out our website for more choices.



**A** **GEOCAN**  
CONCEPTION & DESIGN



**B** **GENUINE JOE**



**C** **GENUINE JOE**

**A Thermal Carafe**

Insulated for cold or hot beverages. 1 liter. Black.  
**GCI K613-BK** (303156)

**B Vacuum Pump Pot**

Keeps beverages hot or cold for up to 12 hours. All stainless steel construction with no glass liner to break. Pressure powered push button easily dispenses beverages. Removable lid allows easy filling and cleaning. 3 liters.  
**GJO 11961** (1064138)

**C Vacuum Carafe**

Everyday carafe that keeps drinks at their optimal temperature longer to preserve their freshness and flavour. Double wall stainless steel construction. 1 litre.  
**GJO 11955** (1064146)

**D Brita® Water Filtration System**

BPA-free materials. Ideal for home or office. Put it right on the counter or refrigerator shelf and you'll always have great-tasting water available from your own filtered water dispenser. 1 filter included. White/clear.  
**CLO 635566CDN1** (596023) 6 cups  
**CLO 642556CDN1** (596015) 10 cups  
**CLO 636178CDN1** (596007) 18 cups



**D** **BRITA**

**E Brita® Replacement Filters**

Used in all Brita® pitchers and dispensers. BPA-free filters reduce Chlorine (taste and odour), copper, mercury and cadmium. Replace filter every two months (151 litres). Package of 3.  
**CLO 635503PAK3** (596031)



**F Wide Mouth Water Bottle**

Made from Tritan. BPA, BPS and Phthalate Free. Wide mouth opening for ice cubes or filtration devices. Completely leak-proof. Easy to clean. Blue with black lid.  
**BML 2178-1116** (674416) 16 oz  
**BML 2178-2024** (674309) 32 oz

**G Frost Paper Cup Dispenser**

Steel construction with an epoxy powder. The slot on the front of the unit allows you to quickly see when cups are running low. Perfect for use by water coolers, fountains and more. To use with standard 4 oz regular or cone cups. 2-3/4 x 2-3/4 x 18 in. White.  
**FPL 185** (1064468)  
• 4 oz cone cups - box of 200  
**SCC 4BR2050** (177220)



**G** **Frost**



**E** **BRITA**



**F** **nalgene**

## A Eco Guardian Cups

Made with sugar cane fiber. Strong and sturdy. Oven and microwave safe. 8 oz. Opaque. Package of 20. 100% compostable.  
**EGU 428417** (428417)

Compostable



A



Compostable



B



## B Compostable Plastic Cup

Fully compostable. Made from clear PLA. Responsibly replaces polystyrene, plastic, and other petroleum based products. Package of 50.  
**EGU EGCPLAK12** (831283) 12 oz  
**EGU EGCPLAK16** (831284) 16 oz  
**EGU EGCPLAK20** (831285) 20 oz  
 • Lid for 12 oz cup - package of 50  
**EGU 831286** (831286)

## C Polar™ Disposable Cups

Polystyrene. For most cold beverages. Can be used with tight fitting flat or domed lids. Smooth and clear surface. Package of 25.  
**PLR 55007** (743369) 7 oz  
**PLR 55012** (207092) 12 oz

## D BlueStripe Cold Drink Cups

These cold cups provide the perfect balance of performance and environmental benefits. Package of 50. Clear. 25% post-consumer recycled content.  
**ECO EPCR12PK** (1063932) 12 oz  
**ECO EPCR16PK** (1073402) 16 oz

## E Plastic Cold Cups

Translucent beverage cups have slip-resistant surface for improved grip.  
**GJO 10500** (1064385) 5 oz (box 2500)  
**GJO 10434** (1064500) 9 oz (box 2400)  
**GJO 10435** (1064492) 12 oz (box 1000)  
**GJO 10501** (1064393) 16 oz (box 1000)  
**GJO 10502** (1073329) 20 oz (box 600)

## F Clear Plastic Cups

Cups designed for cold beverages. Made from PET material.  
**GJO 58233** (1064435) 9 oz (pkg 50)  
**GJO 58232** (1064401) 10 oz (pkg 25)  
**GJO 58231** (1064419) 12 oz (pkg 25)  
**GJO 58230** (803957) 16 oz (pkg 25)

## G Party Cups

Durable plastic cup for cold beverage. 16 oz. Package of 50.  
**GJO 11250** (1064476) blue  
**GJO 11251** (1064484) red



C



D



E



F



G





**A**





**B**



**A Dixie® Hot Drink Paper Cup**  
 Poly-lined to protect against soak-thru. Package of 50.  
 90% recycled content.  
**DXE 5338CD** (251744) 8 oz  
**DXE 2346PATH** (251751) 16 oz

**B Bare® Eco-Forward® Cup for Hot Drinks**  
 Single sided. PLA-lined (polylactic acid resin, made from corn starch).  
 Rolled rim. Made with 100% plant-based material. Package of 50.  
 Compostable in a commercial facility (not suitable for backyard composting).  
**SCC 294322** (294322) 8 oz  
**SCC 412PLNJT33** (1064682) 12 oz  
 • **Lid for 12 oz cup - package of 100**  
**DCC TLP3160007** (294124) white



**C**

**C Cold Drink Paper Cups**  
 4 contemporary designs. 3 oz. Package of 200.  
**FOD 051023** (587220)

**D Compostable Drink Cup**  
 Fully compostable. PLA-lined. Hot or cold, fridge, freezer and microwave safe. Package of 50.  
**EGU 829610** (829610) 8 oz  
**EGU 587972** (587972) 10 oz  
**EGU 831281** (831281) 12 oz  
**EGU 831282** (831282) 16 oz  
**Recyclable lids - package of 50**  
**EGU 829611** (829611) 8 oz - black  
**EGU 587980** (587980) 10-20 oz - white

**E Eco-Friendly Cups**  
 Made from compostable paper cups. Package of 50. Biodegradable.  
**GJO 10214** (1064443) 10 oz  
**GJO 10215** (1064451) 12 oz  
 • **Recyclable lids - package of 50**  
**GJO 10212** (1064880)

Compostable



**D**





**E**



**F Ripple Hot Cups**  
 Three layer ripple hot cup. Reduces costs by eliminating the need to use a double cup. Microwavable. Package of 25.  
**GJO 11255PK** (1064550) 8 oz  
**GJO 11256PK** (1064518) 10 oz  
**GJO 11260PK** (1064526) 12 oz  
**GJO 11257PK** (1064534) 16 oz  
 • **Slotted lids - package of 50**  
**GJO 19052PK** (1064898) 8 oz  
**GJO 11259PK** (1064906) 10, 12 or 16 oz

**G Hot Drink Cups**  
 Polyurethane-lined, single walls are designed to hold hot beverages. Cups are made of 100 percent virgin material. Package of 50.  
**GJO 19045PK** (1064583) 8 oz  
**GJO 19046PK** (1064567) 10 oz  
**GJO 19047PK** (1064575) 12 oz  
**GJO 19050PK** (1064591) 16 oz  
**GJO 19051PK** (1064609) 20 oz  
 • **Corrugated sleeves for 12, 14 and 16 oz cups - package of 50**  
**GJO 19049PK** (1065201)



**F**





**G**



## A Compostable Paper Straws

8 in. Made of compostable paper. Individually wrapped. Box of 400.  
**FOD 400300** (597666) striped, assorted colours  
**FOD 027000** (597674) white



## B Paper Straws

Individually wrapped. Box of 500. White.  
**GJO 58945** (1065680)



**B**



## C Wooden Coffee Stir Sticks

Box of 1,000.  
**FOD 80435** (170373) 4-1/2 in.  
**VND 80-414C** (308486) 7 in.



**A**



## D Coffee Condiment Organizer

Inclined design, made from a durable plastic. 7 compartments.  
 5-1/2 x 16 x 7-1/4 in. Black.  
**EMS COMP7-BLK** (1064963)



**D**

\*Accessories not included

## E Mobile Refreshment Cart

Wood laminate construction. Double door design with fixed interior shelf. Large heat-resistant countertop with a 1-1/4 in. raised lip to catch spills. Four 2-inch swivel casters (2 locking). Grey.  
**SAF 8953GR** (320572)



## F Impromptu® Refreshment Cart

Steel frame with black powder coat finish and translucent polycarbonate side panels. 34 x 17 in. cherry laminate top. Fixed interior shelf. Large heat-resistant countertop with a 1-1/4 in. raised lip to catch spills. On casters (2 locking). Black/cherry.  
**SAF 8966BL** (320580)



\*Accessories not included



\*Accessories not included



# COMPOSTABLE & RECYCLABLE DISHES



- Easy to Clean Up
- Compostable
- Recyclable
- Made from Sugar Cane Fiber
- Food Safe - Heat, Grease and Oil-Proof
- Fridge, Freezer & Microwave Safe



## A Eco Party Kit

Includes 10 paper cups, 10-cup sleeves, 4 - 12.5 in platter plates, 10 - 9 in square dinner plates, 20 - 7 in square dessert plates, 10 forks, 10 knives, 10 spoons, and 20 napkins. Package of 104 pieces.  
**EGU EG-KIT-003** (831258)

## B Plates

Package of 50.  
**EGU EG-N-A011** (428383) 7 in.  
**EGUEG-N-A013** (428375) 9 in.  
**EGU EG-N-A005** (428367) 10 in.  
**EGU EG-N-A007** (831261) 10 in. (3 sections)

## C 16 oz bowls

**EGU 428409** (428409) pkg 50  
**EGU EG-N-K001** (831262) pkg 50

## D Cutlery

Package of 30. 10 forks, 10 knives and 10 spoons.  
**EGU EG-A-V005** (517193)

## E Cutlery Kit

Includes 1 each, knife, fork and teaspoon. Box of 400 kits.  
**EGU EG-A-V001** (831260)

## F Individual Cutlery

Package of 50.  
**EGUEG-A-K03** (587139) knife  
**EGUEG-A-K01** (587147) fork  
**EGUEG-A-TS01** (587121) spoon  
**EGUEG-A-SS01** (831259) soup spoon

A



B



C



D

E



F





## A Oval Container

22 oz. Package of 50.

EGU EG-BG-S022 (831275)

• Dome lid - package of 50

EGU 831276 (831276)

## B Multipurpose Round Bowl

32 oz. Paquet de 50

EGU EGBGS32MP (831271)

## C Wide Mouth Bowl

16 oz. Package of 50.

EGU 831273 (831273)

• Lid - package of 50

EGU 831274 (831274)

## D Oval Tray

12 oz. Package of 50.

EGU EG-N-S002 (831277)

• Dome lid - package of 50

EGU 831278 (831278)

## E Hinged Lid Container

Package of 50.

**1 compartment**

EGU EGNC003R1 (831269) 6 x 6 in.

EGU EG-N-C001R (831263) 7 x 5 in.

EGU EGNC034R2 (831265) 9 x 6 in.

EGU EGNC026R1 (831270) 8 x 8-1/2 in.

EGU EGNC025R1 (831267) 9 x 9 in.

**2 compartments**

EGU EG-N-C002R (831264) 9 x 6 in.

**3 compartments**

EGU EGNC031R1 (831266) 8 x 8 in.

EGU EGNC032R2 (831268) 9 x 9 in.

## F Hinged Lid Container

Package of 50.

**1 compartment**

LEF 831162 (831162) 6 x 6 in.

LEF 831164 (831164) 9 x 9 in.

**3 compartments**

LEF 831163 (831163) 9 x 7 in.

All products made from PET recyclable plastic or Bagasse (compostable plant fibres)



**A** ECO Guardian



**B** ECO Guardian



**C** ECO Guardian



**D** ECO Guardian



**E** ECO Guardian



**F** LEAF



**A**



**B**

**A Storage Containers**  
 Designed to snap closed with one simple press on the lid.  
**SJN 70030** (1065532) small square (pkg 4)  
**SJN 70032** (1065524) medium square (pkg 3)  
**SJN 70031** (1065540) large rectangle (pkg 2)

**B Aluminium Container**  
 Keeps the heat, can be refrigerated. Economic and recyclable.  
**GJO 10702** (1073337)  
 10-1/2 x 12-3/4 x 2-2/5 in. (pkg 100)  
**GJO 10703** (1065011)  
 12-4/5 x 20 -7/10 x 2-7/8 in. (pkg 50)



**C**



**D**

**C GLAD Cling Wrap Clear Food Wrap**  
 Easy to handle and microwave-safe.  
**CLO 10637** (456780) 29.5 cm x 30 m  
**CLO 10686** (456798) 29.5 cm x 152 m

**D GLAD Press'n'Seal Wrap**  
 Seals tightly to keep food fresh. 30 cm x 21.6 m.  
**CLO 70441PAK5** (1014711)



**E**



**F**

**E Roll & Wrap 1001™ Food Film**  
 Reusable dispenser box with safety cutter blade. 28 cm x 305 m.  
**RLS 701500** (526574)

**F Spring Grove® Plastic Food Wrapping**  
 Dispenser box. 11 in x 2500 ft.  
**SGG V03693** (829612)



**G**



**H**

**G Spring Grove® Aluminum Foil Wrap**  
 Dispenser box. 30 cm x 200 m roll.  
**VPU V03794** (169649)

**H Durable Aluminum Foil Wrap**  
 Dispenser box. 12 in. x 50 ft.  
**FOD 129856** (549758)



**I**



**J**

**I Glad® Reclosable Sandwich Bag**  
 6 x 6 in. Box of 50.  
**CLO 12615WAVE** (207043)

**J Ziploc® Big Bags With Double Zipper**  
 Perfect for school or at home. 38 x 38 cm. Box of 5.  
**SJN 00195** (602045)



**K**



**L**

**K Ziploc® Storage Bags**  
 Double zipper. Easy to open tabs.  
**SJN 00340** (1065607) 7 x 7-7/16 in. (box 28)  
**SJN 00350** (1065599) 10-1/2 x 10-3/4 in. (box 19)

**L Freezer Bags**  
 Prevents freezer burn while keeping food fresh.  
**SJN 00430** (1065573) 7 x 7-7/16 in. (box 19)  
**SJN 00450** (1065565) 10-9/16 x 10-3/4 in. (box 14)

**M Ziploc® Storage Bags**  
 Commercial package.  
**SJN 70762** (1065516) 6-1/2 x 5-7/8 po (box 500)  
**SJN 70760** (1065730) 13 x 15 in. (box 100)



**M**



**N**

**N Ziploc® Freezer Bags**  
 Commercial pack.  
**SJN 70873** (1065722) 7 x 7-7/16 in. (box 300)  
**SJN 71377** (1065581) 10-9/16 x 10-3/4 in. (box 250)  
**SJN 70761** (1065558) 13 x 15 in. (box 100)

## A Bare® Eco-Forward® Sugercane Plate

Package of 125. Made of 94% renewable resources. Compostable.  
**SCC 6PSC2050** (146480) 6 in.  
**SCC 8PSC2050** (146464) 8-1/4 in.  
**SCC 10PSC2050** (146498) 10 in.



## B Compostable Plates

Package of 125. White.  
**LEF B6-P7-1000** (831160) 7 in.  
**LEF B6-P10-500** (831161) 10 in.

## C Cornstarch Dinnerware Plates

Microwave safe, washable, fully compostable with food waste.  
 Biodegradable in 30-60 days in commercial facilities. 10 in.  
 Package of 125. White.  
**VLB 57125** (596585)

## D Bare® Eco-Forward® Sugercane Bowls

12 oz. Package of 125. Made of 94% renewable resources. Compostable.  
**SCC 12BSC2050** (1064055)



## E Disposable Utensils

White plastic.  
**Package of 24**  
**FOD 90-03024** (342972) knives  
**FOD 90-01024** (319681) forks  
**FOD 90-02024** (669093) teaspoons  
**Box of 1,000**  
**PLR 70041** (728774) knives  
**PLR 70043** (728758) forks  
**PLR 70044** (728766) teaspoons  
**PLR 70042** (728741) tablespoons

## F Bamboo Cutlery Set

Package of 3. Includes a fork, a knife and a spoon. Washable storage bag.  
**GCI XG3BAM** (583278)

## G 5 Piece Breakroom Set

Includes the essentials for food preparation tasks: a cutting board, 3 in. spreader, 4 in. spatula, 8 in. serrated knife and 8 in. chef's knife.  
 Lifetime warranty.  
**ACM 18633** (429993)

## H Steering Wheel Serving Tray

Designed to fit around a car steering wheel. Makes eating or note taking easier. Black.  
**DTA 21700** (829425)



A



B



C



D



E

F **GEO**

G **Clauss**

H



**A** **TORK**



**B** **TORK**



**A Napkin Refill for Classic Café Xpressnap® Tork® Dispenser**

1-ply, 8-1/2 x 8-1/2 in. Box of 500. Natural. 100% recycled, 30% post-consumer content.  
**TRK DX606E** (337758)

**B Napkin Refill for Xpressnap® Tork® Dispenser**

1-ply, 13 x 8-1/2 in. Box of 500. Unbleached. 100% recycled, 30% post-consumer content.  
**TRK DX906E** (293563)

**C Bounty Quilted Napkins**

Bounty napkins cover your meal with just one quilted napkin. Stronger than the next leading paper napkin, for superior value. 1-ply, 12.1 x 12 in. Package of 400.  
**PGC 19096** (513101)

**D White Swan® Napkins**

Overall paisley embossing pattern increases thickness and provides a quality finished look. 1-ply, 11 x 13 in. Package of 500. White. 80% recycled, 70% post-consumer content.  
**KRI 07401** (594184)

**E Chalet Dinner Napkins**

Rose embossing. 2-ply, 1/8 fold. 15 x 16 in. Package of 100. White.  
**KRI 07130** (594192)

**F White Swan® Napkins**

Plain center with embossed border. 2-ply, 15 x 16 in. Package of 188. 80% recycled, 70% post-consumer content.  
**KRI 07655** (549527)

**G Napkin Dispenser**

Chrome.  
**FPL 195** (169789)  
• Junior dispenser napkins - package of 500  
**KRI 08150** (544049)



**C** **Bounty**



**D**  **Kruger**



**E**  **Kruger**



**F**  **Kruger**



**G**

## A Plastic Table Cover

Roll of 40 in. x 300 ft. White.  
**GJO 10324** (1065433)

## B Plastic Round Tablecovers

84 in diameter. Designed to fit neatly on round 48 in. or 60 in. diameter tabletops. Package of 6. White.  
**GJO 10330** (1065441)

## C Plastic Rectangular Tablecovers

Designed to fit standard size cafeteria and conference tables.  
 54 x 108 in. Package of 6.  
**GJO10325** (1065409) blue  
**GJO 10326** (1065417) red  
**GJO 10328** (1065425) white

## D Table Skirt

Table skirt is made of soft, nonwoven polyester for an elegant look.  
 Pleated skirt features self-adhesive backing for easy setup. 29 in. x 14 ft.  
**GJO 11915** (1065193) white  
**GJO 11916** (1065631) black

## E Paper Banquet Tablecloth

Roll of 54 in. x 150 ft. White.  
**FOD 475002** (273037)





**A** stellar



**B** stellar

**A Clear Vinyl Disposable Gloves**

100% PVC. Powder free. Ambidextrous. Non sterile, single use. 4 mm thick. 9.5 in long. Food contact approved. Box of 100.  
**SEF 327293** (829510) small  
**SEF 327294** (829511) medium  
**SEF 327295** (829512) large  
**SEF 327296** (829513) extra-large

**B Blue Vinyl Disposable Gloves**

100% PVC. Powder free. Ambidextrous. Non sterile, single use. 4 mm thick. 9.5 in long. Food contact approved. Box of 100.  
**SEF 327297** (829514) small  
**SEF 327298** (829515) medium  
**SEF 327299** (829516) large  
**SEF 327300** (829517) extra-large

**C Blue Vitridex Examination Gloves**

A unique combination of PVC and Nitrile. Powder free. Ambidextrous. Non sterile, single use. 4 mm thick. 9.5 in long. Food contact approved. Health Canada Class II Medical Device License. Box of 100.  
**SE F003E10400S** (809517) small  
**SEF 003E10400M** (809525) medium  
**SEF 003E10400L** (809533) large  
**SEF 809541** (809541) extra large



**C** stellar



**D** stellar

**D Black Vitridex Disposable Gloves**

A unique combination of PVC and Nitrile. Powder free. Ambidextrous. Non sterile, single use. 4 mm thick. 9.5 in long. Food contact approved. Box of 100.  
**SEF 327353** (829518) small  
**SEF 327354** (829519) medium  
**SEF 327355** (829520) large  
**SEF 327356** (829521) extra-large

**E Polyethylene Disposable Gloves**

High-density polyethylene. Powder free. Ambidextrous. Non sterile, single use. 1 mm thick. 9.5 in long. Food contact approved. Box of 500. Transparent.  
**SEF 004E12580S** (833057) small  
**SEF 004E12580M** (833058) medium  
**SEF 004E12580L** (833059) large  
**SEF 833060** (833060) extra-large



**E** stellar



**F** **RONCO**

**F Latex Gloves**

Powder-free. 4 mil. Box of 100. White.  
**RON 1823SM** (160705) small  
**RON1833MED** (160713) medium  
**RONDV1843** (160721) large

**G Nitech® EDT Examination Gloves**

Manufactured from a patented blend of premium quality synthetic materials. 100% powder free, latex free, and ideal for a number of food, medical and general uses. Easy Donning Technology facilitates donning of gloves in wet, humid or sweaty conditions. CFIA accepted. Licensed for medical use. 5 mil thickness. Box of 100.  
**RON375** (320002) medium  
**RON385** (320044) large  
**RON 395XL** (574384) XL  
**RON395XX** (574392) XXL



**G** **RONCO**



**H** **RONCO**

**H Aloe Synthetic Stretch Disposable Gloves**

Vinyl based co-polymer. As your hands perspire, aloe is released in the gloves, rejuvenating your hands while you work. Flexible ease of movement. Compliant for contact with food. Ambidextrous. 5 mil. Powder free. Large. Box of 100. Green.  
**RON 647** (511063)

## A Light-Fit Latex Reusable Gloves

This light-duty flock lined 16 mil reusable glove has honeycomb texture on the palm and fingers for excellent grip in dry/wet applications. Cotton flock lining for added comfort and absorbency. Good resistance to a variety of chemicals. CFIA accepted. Medium. Package of 12 pairs. Yellow.  
**RON 15-332-08** (307983)



## B Flexsor™ 76-400 Gloves

Nylon with nitrile palm coating. Excellent hand form, fit and dexterity. Nitrile coating provides excellent abrasion resistance and dry grip. For a wide variety of dry surface applications. Seamless. Latex free. CFIA approved. Box of 12 pairs.  
**RON7640008** (331405) medium  
**RON 7640009** (320283) large



## C Flexsor™ 78-500 Gloves

Nylon with polyurethane palm coating. Ideal for all types of detailed assembly, installation, packing, inspection and small parts handling applications. Breathable nylon liner. Offer grip on wet or dry applications. Seamless. Latex free. CFIA approved. Package of 12 pairs. Black.  
**RON 78-500-08** (331421) medium  
**RON 78-500-09** (331959) large  
**RON 78-500-10** (574350) XL

**A** **RONCO**

**B** **RONCO**

## D PrimaCut™ 69-380 Gloves

Abrasion, cut, tear and puncture resistance without compromising comfort. Manufactured with a 13 gauge HPPE fibre shell with a grey polyurethane coating. Breathable and flexible. Machine washable. Cut resistance level 3. Box of 6 pairs.  
**RON 69-380-07** (574277) small  
**RON69-380-08** (574285) medium  
**RON 69-380-09** (574301) large  
**RON 69-380-10** (574319) XL  
**RON69-380-11** (574327) XXL



## E GRIP-IT™ 77-500 Gloves

General work glove that protects against abrasions, snags and nuisance cuts. Natural latex crinkle coating that delivers superb grip. Grip on wet or dry applications. Flexible and lightweight for ease of use. Breathable material. Knitwrist cuff for snug fit. Box of 12 pairs.  
**RON77-500-10** (574343) XL  
**RON 77-500-11** (574335) XXL

## F Iceberg™ 77-603 Gloves

For applications in sub-zero conditions. Green outer layer for maximum visibility. Palm coated with HiViz latex. Napped acrylic inner layer gives extra warmth in cold conditions. Excellent dexterity in wet/dry conditions. Flexible and light for easy use. Package of 6 pairs.  
**RON 77-603-08** (579805) medium  
**RON 77-603-09** (579813) large  
**RON 77-603-10** (579821) XL  
**RON 77-603-11** (579839) XXL

**C** **RONCO**

**D** **RONCO**



**E** **RONCO**

**F** **RONCO**



**A** **KG**  
KLEENGUARD®



**B** **KG**  
KLEENGUARD®

**A Unispec™ II Safety Glasses**

Clear polycarbonate. Provide 99.9% UVA/UVB/UV-C protection. One-size fits most. Box of 50.  
**KCC 25646** (829899)

**B KleenGuard Economy Safety Glasses**

Padded temples for enhanced comfort. Polycarbonate lenses provide 99.9% UVA/UVB/UV-C protection and are hardcoated for scratch protection.  
**KCC 25654** (829900)

**C KleenGuard Maverick Safety Glasses**

Integrated side shields. Polycarbonate lenses provide 99.9% UVA/UVB/UV-C protection. Clear anti-fog lens.  
**KCC49301** (829903) clear and orange  
**KCC49309** (829901) black  
**KCC 49312** (829902) black and orange



**C** **KG**  
KLEENGUARD®



**D Crews Stratos® Safety Glasses**

Clear lens treated with scratch-resistant coating. Adjustable spatula temples for locked-in-place fit. Universal nosebridge fits a variety of facial profiles. CSA Z94.3 certified.  
**MCS SS110** (294009)

**E Over-the-Glass Safety Eyewear**

Durable lenses help provide limited protection from light to moderate impact hazards. Accommodates most personal eyewear. Lightweight design for comfort and lasting use. Scratch-resistant coating helps keep vision clear.  
**MMM 47110H1-DC** (597096)



**D**

**F SecureFit™ Professional Safety Eyewear**

Durable lenses help provide limited protection from light to moderate impact hazards. Padded temples for added comfort over the ears. Soft, conformable nose pads provide customizable comfort.  
**MMM SF400CWV6P** (597138)

**G Nova Safety Glasses**

Fits over most prescription eyewear. The frame design prevents overlapping at the temples, for absolute comfort. Anti-Scratch Plus protects from scratches and abrasions. Meets or exceeds CAN/CSA Z94.3-07. Polycarbonate. One Size. Sold by each. Black frame with clear lens.  
**RON 82-650** (520668)



**E** **3M**

**H Chemical Splash and Impact Goggles**

Durable, one-piece lens. Flexible frame conforms to your face for a secure, protective fit. Adjustable strap. Indirect ventilation helps keep liquids out of your eyes and helps reduce fogging.  
**MMM 93506H1-C** (597104)

**I Protective Face Shield**

Double sided anti-fog face shield. Protects full face. Lightweight. Good elasticity. Skin friendly sponge. 13 x 8.5 in. Reusable. Package of 5.  
**NVX 801266** (801266)



**F** **3M**



**G** **RONCO**



**H** **3M**



**I**





## A Eyewash Station

Station with one 500 ml eye wash bottle. Durable plastic construction. Wall mountable. 11 x 3-1/2 x 13 in.  
**FX 560003** (829918)  
 • Eyewash - 500 ml  
**FX 100485** (829919)



## B Gravity Fed Eyewash Station

Uses water and standard preservative. Self-contained, gravity-fed. Does not need to be plumbed in. Fast installation and flexible movement to meet work site changes. Wall-mounting bracket, drainage hose and maintenance card tag included.  
**FX 91287-CA** (829920)  
 • Additive concentrate - 236 ml  
**FX 560120** (829921)

**A**

**B**

## C 8210 Particulate Respirator

N95 approved filtering facepiece particulate respirator. For grinding, sanding, sweeping, bagging and other dusty operations. Pack of 20.  
**MMM 8210PB1AC** (293191)



**C** **3M**

## D 8511 N95 Particulate Respirator with Cool-Flow™ valve

NIOSH approved. Patented 3M Cool Flow exhalation valve offers cool, dry comfort. Helps reduce risk of inhalation exposure to certain airborne biological particulates, such as influenza, as well as dust, mold, welding fumes, etc. Adjustable M-nose clip. Package of 10.  
**MMM 331561** (331561)



**D** **3M**



## E Level 1 Procedure Masks

Fitted nose piece to ensure proper fit. 3 layers of breathable non-woven fabric. Easy to put on with round elastic ear loops. Latex free. 95% bacterial filtration efficiency. Sub-micron particulate efficiency at 0.1 µm >= 95%. Resistance to penetration by synthetic blood at 80 mmHg. Class 1 flame spread. These masks should be disposed after each use. 175 x 175 mm. Box of 50. Blue. ASTM 2100 certification.  
**COF 19021** (823146)

**C** **3M**

## F Level 2 Procedure Masks

Fitted nose piece to ensure proper fit. 3 layers of breathable non-woven fabric. Easy to put on with round elastic ear loops. Latex free. 98% bacterial filtration efficiency. Sub-micron particulate efficiency at 0.1 µm >= 98%. Resistance to penetration by synthetic blood at 120 mmHg. Class 1 flame spread. These masks should be disposed after each use. Box of 50. Blue. ASTM 2100 certification.  
**COF 19022** (823864)



## G Level 3 Procedure Masks

Fitted nose piece to ensure proper fit. 3 layers of breathable non-woven fabric. Easy to put on with round elastic ear loops. Latex free. 98% bacterial filtration efficiency. Sub-micron particulate efficiency at 0.1 µm >= 98%. Resistance to penetration by synthetic blood at 160 mmHg. Class 1 flame spread. These masks should be disposed after each use. Box of 50. Blue. ASTM 2100 certification.  
**COF 19023** (828486)

**E** **CONTINENTAL**



**F** **CONTINENTAL**



## H KleenGuard™ N95 Pouch Respirators

N95 NIOSH-Approved (TC# 84A-9042). Provides a minimum of 95% filtration efficiency of 0.3 micron particles. Adjustable nosepiece to customize fit. Head straps made of patented material that provides the right balance of softness, stretchiness, and strength. Unique pouch design provides more space for warm breath to dissipate. Box of 20. White.  
**KLG 53899** (828529)



**G** **CONTINENTAL**



**H** **KG**  
**KLEENGUARD**





**A** **RONCO**



**B** **RONCO**



**A Cova-Cap® Pleated Bouffant Cap**

Made from 100% non-woven polypropylene. Unique accordion pleated style allows them to be refolded with a snap of the wrist at shift changes. Ideal for work environments that follow colour coded departments for HACCP compliance. Flexible and lightweight for ease of use. Latex-free. 21 in. Package of 250. Blue.  
**RON 775** (511238)

**B Shoe Covers**

Microporx microfiber. Extra-large. Box of 100. White.  
**RON 1992XL** (271353)

**C COVERME™ Polypropylene Shoe Covers**

Economical and disposable. Helps protect floors from dirt or other contaminants. Non-woven, anti-dust and anti-static for light protection. Anti-slip strips on the bottom. Box of 100. Blue.  
**RON 1991** (511246) regular  
**RON1991XL** (511253) X-large

**D H-702V Hard Hat**

Comfortable, 4-point pinlock or ratchet suspension with height adjustment. Replaceable brow pad. Short brim for better upward visibility. Meets requirements of ANSI/ISEA Z89.1-2009 Type 1, Class C and CSA Z94.1-05 Type 1, Class C. Yellow.  
**MMM CHH-RY6-PS** (439653)



**C** **RONCO**



**D** **3M**

**E Tekk Protection™ Day/Night Safety Vest**

Highly reflective vest suited for recreation or light duty uses. 1 in Scotchlite™ reflective stripes. Breathable mesh design. Adjustable straps for one size fits most. Includes a cell phone pocket. Yellow.  
**MMM 94601H1-DC** (559740)

**F High-Viz Traffic Vest**

Made of comfortable breathable mesh with velcro closures. Five point tear away safety vest with reflective stripes on the front and back. Tears away at shoulders, waist and sides. One size. Orange.  
**RON 90350** (178467)

**G Open Road®Solid Safety Vest**

Solid polyester material for added coverage. 2" DM® reflective tape. Front hook-and-loop closure. 2 pockets, one inside and one outside. Machine washable. Orange and lime. Fully compliant with CSA Z96-15 Class 2, level 2 and becomes Class 3 in combination with the right model arm and leg bands. Black: compliant to ANSI/ISEA 107-2015, Type R, level 2, not FR.

**Lime**

**VIK 6106G-S/M** (514125) S-M

**VIK 6106G-L/XL** (514133) L-XL

**Orange**

**VIK 61060-S/M** (514109) S-M

**VIK 61060-L/XL** (514117) L-XL

**Black**

**VIK6106BK-SM** (514141) S-M

**VIK6106BKXL** (514158) L-XL



**E** **3M**



**F** **RONCO**



**G** **VIKING**

## A Open Road® BTE Safety Vest

Entry level safety vest. Polyester, fluorescent mesh fabric for comfort and breathability. Dual chest strap for ID badge, cell or radio. Front velcro closure. Machine washable. 2 in ANSI Certified reflective material in 4 in contrasting tape. Fully compliant with CSA Z96-09 Class 2, Level 2 and becomes Class 3 in combination with right model arm and leg bands. Fully compliant with ANSI/ISEA 107-2010 Class 2 Level 2.

### Lime

**VIK 6110G-S/M** (514182) S-M

**VIK 6110G-L/XL** (514190) L-XL

### Orange

**VIK 61100-S/M** (514166) S-M

**VIK 61100-L/XL** (514174) L-XL



## B 5-Point Safety Vest

Industry level safety vest for conventional job duties that require CSA/ANSI high visibility safety protection and for job sites that require 5 point tear away protection in safety situations. Solid breathable polyester material for added coverage. Safety D-ring slot access. Dual chest strap for ID badge, cell or radio. Four front pockets. 2 in ANSI Certified reflective material in 4 in contrasting tape. Fully compliant with CSA Z96-09 Class 2, Level 2 and becomes Class 3 in combination with right model arm and leg bands. Fully compliant with ANSI/ISEA 107-2010 Class 2 Level 2.

### Lime

**VIK 6135G-S/M** (514224) S-M

**VIK 6135G-L/XL** (514232) L-XL

### Orange

**VIK 61350-S/M** (514208) S-M

**VIK 61350-L/XL** (514216) L-XL



## C Journeyman Safety T-Shirt

Premium non-transparent double layer polyester fabric for better breathability. Crew neck style. 2 in ANSI Certified reflective material in 4 in contrasting tape. Dual chest strap for ID badge, cell or radio. Velcro sealed chest pocket. Fully compliant with CSA Z96-09 Class 2, Level 2 and becomes Class 3 in combination with right model arm and leg bands. Fully compliant with ANSI/ISEA 107-2010 Class 2 Level 2.

### Lime

**VIK 6006G-M** (514273) M

**VIK 6006G-L** (514281) L

**VIK 6006G-XL** (514299) XL

### Orange

**VIK 60060-M** (514240) M

**VIK 60060-L** (514257) L

**VIK 60060-XL** (514265) XL



## D Safety Cotton Lined Long Sleeve Shirt

The dual layer cotton back gives the wearer the feel of cotton and breathability of "Quick Dry" and provides more comfort than polyester. Dual layer cotton also decreases irritation and does not have a strong fabric scent compared to polyester material. The hi-visibility polyester outer layer holds color longer and is CSA compliant. Dual chest strap for ID badge, cell or radio. Velcro sealed chest pocket. Ultraviolet Protection Factor (UPF) of 50+. Blocks 98% of UV radiation from passing through the shirt. Dual chest straps for ID Badge/Cell/Radio. Velcro sealed chest pocket. Green & orange are fully compliant with CSA Z96-09 Class 2 Level 2 & ANSI/ISEA 107-2010 Class 3 Level 2, and become CSA Z96-09 Class 3 when combined with the correct arm and leg bands. Navy is fully compliant with CSA Z96-09 Class 1 Level 2 & ANSI/ISEA 107-2010 Class 1 Level 2.

### Lime

**VIK 6015G-M** (514331) M

**VIK 6015G-L** (514349) L

**VIK 6015G-XL** (514356) XL

### Orange

**VIK 60150-M** (514307) M

**VIK 60150-L** (514315) L

**VIK 60150-XL** (514323) XL

### Blue

**VIK 6015N-M** (514364) M

**VIK 6015N-L** (514372) L

**VIK 6015N-XL** (514380) XL





**A 3M**



**B 3M**

**A Optime™ Peltor™ 101 Earmuffs**

Stainless steel headband for consistent force and effective hearing protection. Resists bending and warping. Earcup pivot points tilt for optimum comfort and efficiency. Liquid foam filled earmuff cushions. For noise levels up to 101 dBA. Noise reduction rating of 27 dBA. Black. **MMM H7A** (322263)

**B Optime™ Peltor™ 105 Earmuffs**

Double shell technology for effective hearing protection. Stainless steel headband resists bending and warping. Earcup pivot points tilt for optimum comfort and efficiency. Liquid foam filled earmuff cushions. For noise levels up to 105 dBA. Noise reduction rating of 30 dBA. Black/red. **MMM H10A** (322255)

**C PELTOR™ Optime™ 98 Earmuffs**

Feature a stainless steel headband for consistent force and effective hearing protection. They are lightweight, comfortable and designed with ultra light liquid and foam filled earmuff cushions. Noise Reduction Rating (NRR)\*: 25 dB. CSA Class A. Black/yellow. **MMM H9A** (788737)



**C 3M**



**D 3M**

**D E-A-R™ Classic™ Uncorded Earplugs**

Soft energy absorbing polymer foam which provides excellent hearing protection and all-day comfort. Roll-down cylindrical shape. 33 decibels noise reduction rating. Package of 200. Yellow. **MMM 312-1201** (322198)

**E E-A-Rsoft™ Yellow Neons™ Earplugs**

Polyurethane roll-down foam. Tapered shape. Noise reduction of 33 decibels. Package of 200. **MMM 312-1250** (307959)

**F Tekk Protection™ Banded Hearing Protection**

Noise reduction rating of 28 dB. Pliable foam ear tips conform to the shape of your ear canal to help block out hazardous noise. Soft, smooth ear tips enhance comfort for extended wear. Ear tips are removable and replaceable. Easy to insert and remove. Package of 1 pair. **MMM 90537H1-DC** (597112)



**E 3M**



**F 3M**



**G Tekk Protection™ Disposable Earplugs**

Noise reduction rating of 32 dB. Pliable design slowly expands, conforming to your ear canal to help block out hazardous noise. Soft, smooth design enhances comfort for longer wear. Easy to insert and remove. Package of 4 pairs. Assorted colours. **MMM 92050H4-DC** (559393)

**H Disposable Earplugs**

Fits a wide range of ear canals. Expandable and contoured for a comfortable fit. 32dB NRR. Package of 80 pairs. **MMM 550335** (550335)



**G 3M**



**H 3M**

## A Barricade CAUTION Tape

Yellow polyethylene plastic with black letters. 3" x 300', roll.  
**MMM 301** (322271)



## B Hazard Marking Duct Tape

High visibility pattern. Mark overhead hazards. Natural rubber adhesive.  
 High adhesion. Polyethylene backing. Poly/cotton scrim. 48 mm x 22.8 m.  
 Red and white stripes.  
**MMM1125-RW** (829129)



## C Caution Sign

Designed for convenient storage or transport on janitor cart.  
 13 in triangle with bold graphics in 3 languages. Stable, self-opening base.  
 ANSI- and OSHA-compliant. 13 x 13-1/4 x 26 in. Yellow.  
**RUB 123125** (123125)



## D Caution Wet Floor Sign

Foldable design with locking-type handles. 26 x 11 in. Yellow.  
**RUB 611285YEL** (290494) French-English  
**RUB 611277YW** (1015214) English



## E Door Wedge

Crush resistant. 2 in. Black.  
**MGE 10209470** (547901)

## F Door Wedge

Crush resistant. 5 in. Package of 2. Black.  
**VLB 78012** (549865)

## G Shepherd Door Stopper

Safely wedges doors with up to 1-1/2 in of floor clearance. Beige.  
**SDU 09163** (669390)

## H Signal Horn

Easy to use and hold. Audible horn can be heard over a mile.  
 Non-flammable. 142 g.  
**EMP 46700** (829609)



*Energizer*



**A**

**N**  
2023



**B**

**N**  
2023



**C**

**N**  
2023

**A Tactical Metal Flashlight**

Features high, low and emergency strobe light modes. Water-resistant and impact resistance up to 1m. Black.  
**EVE ENPMHT1L** (829642)

**B Waterproof Flashlight**

LED 2x AA batteries included. Red.  
**EVE WRWP21E** (829643)

**C Rechargeable Flashlight**

LED. Metal construction. Lanyard easily attaches to your wrist. 3 modes. Rechargeable (USB cable included).  
**EVE ROVVNHAL8H** (829644)

**D Vision HD Flashlight**

LED. 400 lumens. 7 modes. Includes 2 AA batteries. Black.  
**EVE EPMZH21E** (829645)

**E Vision HD Focus Tactical Flashlight**

Rear push button to easily change modes. Compact and lightweight. Rechargeable batteries. LED. 700 Lumens. Black.  
**EVE ENPMTRL8** (829646)



**D**

**N**  
2023



**E**

**N**  
2023



**F**

**F Metal Pen Light**

Super bright LED bulb for 18 hour run time. Push button switch. 2 AAA alkaline batteries included.  
**EVE PLED23AEH** (144642)

**G ReadyFlex® LED Floating Lantern**

175 meter beam. Autonomy up to 140 hours on 4 carbon-zinc batteries or 400 hours on 4 alkaline batteries. Works with 2 or 4 batteries. 80 lumens. 5 times brighter than standard LED. Includes 2 D batteries.  
**EVE EVGPLN45H** (164178)

**H Vision HD + LED Headlight**

250 lumens. Impact resistant and waterproof. High and low switch. Approx. 50 hrs runtime. 70' beam. 3 x AAA batteries included.  
**EVE HDC32E** (350314)

**I Compact LED Flashlight**

1 LED bulb provides 80 lumens. 5-hour run time. Focusing lens. 75 po de long. Includes 3 AAA batteries.  
**EVE EVML33A-S** (571968)



**G**



**H**



**I**

**J Energizer 360° Lantern**

LED Technology. Low mode: 50 lumens, 650-hour run time. High mode: 500 lumens. 150-hour run time. 1 meter shock proof. USB port. Water resistant. 3 D or 3 AA batteries not included.  
**EVE WRESAL35** (579185)

**K Weather Ready LED Rechargeable Flashlight**

Emergency light stays plugged into a wall and automatically turns on in the event of a power outage. Retractable prongs allow you to easily use it as a flashlight. 60 lumens. Powered by a rechargeable NiMH battery. White.  
**EVE RCL1FN2WR** (587287)



**J**



**K**



**L**

**L Book Light**

Provides wide illumination of objects up to 4 meters. Warm white LED. Clip attaches to surfaces up to 0.5 inches (13mm) thick. Flexible neck allows users to precisely direct the light. Collapses and locks for easy storage.  
**EVE FNL2BU1CS** (805581)

# First aid kits

for federal, provincial  
and territorial regions  
of Canada



Every employer must provide an adequate number of first aid kits. They must be easy for workers to access and as close as possible to the work area.

**All delivered kits are CSA Z1220-17 compliant.**

Contents must be refilled when used to remain compliant.



Ask your dealer or representative about the **kits for your province or territory.**



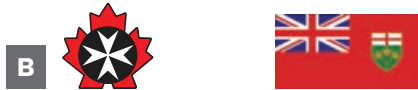

**A Level B Canada Labour Code First Aid Kit**

134 pieces. Kit contains: 48 adhesive bandages, 6 triangular bandages, 1 pair of scissor for bandage, 2 adhesive tapes – 2.5 cm x 4.6 m, 4 pairs of vinyl gloves powder free- large, 1 accident record book, 12 sterile gauze pads – 10 x 10 cm, 10 antiseptic cleansing wipes, 2 compress bandage – 10 x 10 cm, 40 gauze sponges – 10 x 10 cm, 6 self-adhering gauze bandages – 7.6 cm x 3.7m, 1 splinter forceps, 1 CPR face mask. **CWH 8200FGP** (312074)

**B Ontario Complete Workplace First Aid Kit**

320 pieces. Exceeds Ontario's Workplace Safety and Insurance Board regulations for workplaces with up to fifteen employees per shift. Carrying handle. Wall mountable. **SJA 01379** (313635)

**C Federal First Aid Truck Kit**

68 pieces. General-purpose first aid kit designed for transport vehicles. Contains supplies to treat small and large injuries. Exceeds minimum standards for Occupational Health and Safety for kit type A. **SFO 898-120020** (324525)

**D St. John Ambulance First Aid Kits and Refills**

First aid kit compliant with national standards.  
**135-piece refill (federal standard)**  
**SJA 51242UNIT** (251207)  
**84-piece bandages refill**  
**SJA SCRF-01** (251215)

**E Nexcare™ First Aid Kit**

For treatment of minor injuries at home, office, and school. Bilingual instructions. Hard, durable case. **MMM 7721P** (743674) 64 items  
**MMM 7730** (399949) 174 items

**F Essential First Aid Kit**

150 pieces.  
**FXX FAC-420N** (828915) nylon case  
**FXX FAC-410P** (828916) plastic case

**G Eye Injury Nylon First Aid Kit**

Includes 5 eyewash of 30 ml, 3 eye pads, 1 eye shield, and 1 eye bath/cup. **FXX FAC032N** (829922)





## A Liquid Bandage Spray

Liquid spray forms a protective coating over minor skin scrapes and abrasions. Ideal for large scrapes and hard to bandage areas. Waterproof. Free of alcohol, fragrances and preservatives and doesn't sting when applied. 18 ml.  
**MMM 118-03-CA** (146357)



**A** Nexcare

## B Clear Waterproof Bandages

Waterproof but breathable. Ultra-thin and comfortable. Diamond shape provides a proper seal around the pad. Assorted sizes. Box of 30.  
**MMM 588-30-CA** (827843)



**B** Nexcare

## C Max Hold Waterproof Bandages

Protects against germs and dirt. Sticks for up to 48 hours. Contours to hard-to-fit places, like heels, the hand, knees, and fingers. Assorted sizes. Box of 40.  
**MMM MHW-40-CA** (585372)



**C** Nexcare

## D Ultra Stretch Bandages

Stretches in all four directions. Breathable, conformable construction adjusts with movement. Diamond shape provides a proper seal around the pad.  
**MMM CS102-CA** (827844) 3/4 x 3 in. (box 80)  
**MMM CS201-CA** (827845) assorted sizes (box 50)  
**MMM CS203-CA** (827846) assorted sizes (box 80)



**D** Nexcare

## E Fabric Bandages

Made from durable and breathable fabric material. Flexes and moves with the wearer. Assorted sizes. Box of 40.  
**MMM HD202-CA** (827847)



**E** Nexcare

## F Plastic Bandages

Water-resistant bandages cushion wounds and offer protection against infection for minor cuts, scrapes and burns. Strong adhesive. Latex free. Assorted sizes. Box of 100.  
**SFO 03526** (312447)



**F** SAFE CROSS FIRST AID

## G Fabric Bandages

Open-weave cotton/rayon woven fabric bandages cushion wounds and offer protection against infection for minor cuts, scrapes and burns. Strong adhesive. 2.2 cm x 7.6 cm. Box of 100.  
**SFO 03026** (312454)

**E** Nexcare

## H Special Use Bandages

Highly absorbent, non-adherent pad keeps the wound clean and dry for faster healing. Designed to provide coverage, protection and comfort for hard-to-bandage areas. Island pad construction seals out dirt and contaminants. Box of 12.  
**Fingertips, 4.4 x 5.1 cm**  
**SFO 2124** (312538)  
**Knuckles, 3.8 x 7.6 cm**  
**SFO 2123** (331389)

**F** SAFE CROSS FIRST AID

## I Finger Bandages

Flexible lightweight fabric. Sterile. Latex-free. 1-1/2 x 3 in. Package of 50.  
**FXX 500141** (828922) knuckle  
**FXX 500126** (828923) fingertip

**G** SAFE CROSS FIRST AID

## J Fabric Bandages

Flexible lightweight fabric. Sterile. Latex-free. 1 x 3 in. Package of 50.  
**FXX 500118** (828924)

**H** SAFE CROSS FIRST AID

## K Butterfly Wound Closure Bandages

Sterile. Latex-free. Medium size. 1 x 4.5 cm. Package of 100.  
**FXX 500158** (828928)

**I** FIRST AID CENTRAL



**J** FIRST AID CENTRAL



**K** FIRST AID CENTRAL





**A** **SAFE CROSS**  
**FIRST AID** 100



**B** **FIRST AID**  
**CENTRAL**

**A Hydrogen Peroxide**

Topical antiseptic for cuts, scratches, sores and ulcers.  
Hydrogen peroxide 3%. 100 ml.  
**SFO 06271** (520429)

**B Alcohol Antiseptic Wipes**

Box of 200.  
**FXX 100034** (828919)

**C Sterile Gauze Pads**

12-ply, 2 x 2 in. Package of 25.  
**FXX 150225** (828925)

**D Non-Sterile Gauze Pads**

8-ply. Package of 200.  
**FXX 150202** (828926) 2 x 2 in  
**FXX 150204** (828927) 4 x 4 in

**E Absorbent Cotton Balls**

Non-sterile. Large size. Package of 1000.  
**FXX 3169** (828929)

**F Sterile Eye Pads**

Oval-shaped. Package of 10.  
**FXX 150132** (828930)

**G First Aid Tape**

2.5 cm x 9.1 m.  
**FXX 500086** (828931) clear  
**FXX 500069** (828932) cloth

**H Conforming Gauze Bandage**

For support and compression. Sold by each.  
**FXX 200002** (828940) 5.1 cm x 4.5 m  
**FXX 200005** (828942) 10.2 cm x 4.5 m



**C** **FIRST AID**  
**CENTRAL**



**D** **FIRST AID**  
**CENTRAL**



**E** **FIRST AID**  
**CENTRAL**



**F** **FIRST AID**  
**CENTRAL**



**G** **FIRST AID**  
**CENTRAL**



**H** **FIRST AID**  
**CENTRAL**

## A First Aid Scissors

15.9 cm.  
SFO 19577 (313189)

## B Bandage Scissors

Curved blades to facilitate cutting dressings close to the skin. 4-1/2 in.  
FFX 550009 (828921)

## C Metal Tweezer

3.5 in.  
FFX 550103 (828920)

## D Self-Adhering Elastic Bandage

Provides localized compression. No pins or clips needed.  
Adheres to itself. Retains elasticity, even after washing. 3 in. wide.  
MMM 207868 (521062)

## E Adjustable Back Brace

Comfortable for all day wear. Mesh panels allow for excess heat and moisture to escape. Odour resistant. One size fits most. Black.  
MMM 207744 (550285)

## F Self-Adhesive Wrap

Lightweight, breathable, reusable.  
FFX 210025 (828935) 5 cm x 4.5 m  
FFX 210020 (829003) 7.6 cm x 4.5 m

## G Elastic Bandage Wrap

For support and compression.  
FFX 200004 (829004) 5 cm x 4.5 m  
FFX 200007 (828939) 10.2 cm x 4.5 m

## H Triangular Bandage

Non-sterile. Non-woven. Includes 2 safety pins. 40 x 40 x 56 in.  
FFX 150030 (828956)



**A** SAFE CROSS  
FIRST AID CENTRAL



**B** FIRST AID CENTRAL



**C** FIRST AID CENTRAL



**D** tensor



**E** tensor



**F** FIRST AID CENTRAL



**G** FIRST AID CENTRAL



**H** FIRST AID CENTRAL

 <p><b>A</b> BIOS H<sub>2</sub>O</p>	 <p><b>B</b> BIOS H<sub>2</sub>O</p> 	<p><b>A Instant Response Fever Thermometer</b> Perfect for every member of the family and has three different modes: Oral, Rectal and Axillary (Underarm). The LCD will turn red when a fever is detected. Protective case, 5 probe covers and battery included (1 x CR2032). <b>BML 237DI</b> (512012)</p> <p><b>B Forehead Thermometer</b> Provides fast and accurate readings in 1 second. Users will be able to recall the last 20 readings. Auto-Shut off. Wide range measurement from 0°C to 100.0°C. 2 x AAA batteries required (not included). <b>BML 275DI</b> (801142)</p>
 <p><b>C</b></p>	 <p><b>D</b> SAFE ACROSS FIRST AID LTD</p>	<p><b>C Non-Contact Infrared Thermometer.</b> Features an infrared sensor allowing temperatures to be measured with no skin contact required. Detection at a distance of 3 to 5 cm. Has a LCD backlit screen with a clear, easy to read display and has a 32 reading memory recall. Dual reading for fahrenheit or celsius. Requires 2 AA batteries (not included). <b>FXX JXB178B</b> (804427)</p> <p><b>D St. John Ambulance CPR Mask Kit</b> Cardiopulmonary resuscitation pocket mask in shell case. Features 2 separate valves working independently to increase first aid safety. Fits most adults, children and infants. Latex-free. <b>SFO 8124-H</b> (190488)</p>
 <p><b>E</b> FIRST AID CENTRAL</p>	 <p><b>F</b></p>	<p><b>E CPR Face Mask With One-Way Valve</b> Complete with gloves and plastic case. <b>FXX 370001G</b> (828943)</p> <p><b>F Rapid Relief Instant Cold Pack</b> Fast relief for bruises, swelling, muscle spasm and pain, headaches and minor injuries. Latex free. Disposable. 25 x 15 cm. <b>SFO 14130</b> (312546)</p>
 <p><b>G</b> FIRST AID CENTRAL</p>	 <p><b>H</b> FIRST AID CENTRAL</p>	<p><b>G Instant Cold Pack</b> Single use. Non-toxic. Quick relief for swelling and bruises, muscle pain, minor injuries, and headaches. <b>FXX 700000</b> (828957) 4 x 5 in. <b>FXX 700006</b> (828958) 6 x 9 in.</p> <p><b>H Cold/Hot Gel Compress</b> Reusable. Non-toxic. Soothes aches, pains, bumps, and bruises. Microwaveable. Always stays flexible. <b>FXX 700011</b> (828959) 5 x 9 in. <b>FXX 700008</b> (828960) 9 x 11 in.</p>
 <p><b>I</b> FIRST AID CENTRAL</p>		<p><b>I Burn Relief Gel</b> 3.5 g. Package of 6. <b>FXX 150169</b> (828970)</p>

## A Hand Warmers

Ready-to-use, safe, natural heat Air-activated, lasts up to 8 hours.  
Box of 40.  
FXX 700002-C (829924)

## B Multi-Fibre Emergency Blanket

Helps reduce shock and prevent hypothermia in accident victims.  
41 x 72 in. Grey.  
FXX BK4110 (828954)

## C Emergency Survival Blanket

Windproof and waterproof. Reflects heat back to body.  
FXX 350001 (828955)

## D Double-Fold Aluminum Stretcher

With storage case. Orange.  
FXX 310007 (828953)

## E Sharps Container

5.1 litre capacity. Yellow.  
FXX 300974 (828961)

## F Medical Exam Table Paper

18 in. x 225 ft.  
FXX MTP181251 (828944) crepe  
FXX MTP182251 (828945) smooth  
21 in. x 125 ft.  
FXX MTP211251 (828946) crepe  
FXX MTP212251 (828947) smooth

## G Tongue Depressors

Sterile. 6 in. Package of 100.  
FXX 4314 (828948)

## H Wooden Splints

Assorted sizes. Package of 6.  
FXX 550120 (828949)



**A**



**B**



**C** **FIRST AID CENTRAL**



**D**



**E**



**F**



**G**



**H**



**A Vicks VapoInhaler™ Nasal Decongestant**

Provides temporary relief of nasal congestion due to cold symptoms. Easy to carry in a pocket or purse and can be used almost anywhere. 0.2 ml. Box of 24.

**PGC 30000** (829224)

**B Vicks Cherry VapoDrops Drops**

Relieves sore throat and cough commonly associated with a cold. Contains effective medicine to suppress your impulse to cough. Cherry. 20 drops per pack. Box of 120 packs.

**PGC 10274** (829225)

**C Sun Zone Sport Sun Screen**

Continuous water resistant spray solution. UVA/UVB protection. Paraben free. Light, non-greasy. Contains natural ingredients including aloe, green tea extract and vitamin E. SPF 30.

**EMP 25325** (524389)

**D SPF 50+ Sunscreen Spray**

Regular use along with limited time in the sun can help decrease the risk of premature skin aging. Dermatologist tested, hypoallergenic and noncomedogenic. Oxybenzone free. Paraben and PABA free. Water and sweat resistant (80 minutes).

**EMP 25465** (829607) 50 ml

**EMP 25461** (829386) 177 ml

**E Solar Cream SPF 50+**

Fragrance free lotion is ideal for all skin types. Regular use along with limited time in the sun can help decrease the risk of skin premature aging. Dermatologist tested and hypoallergenic. Oxybenzone free. Water and sweat resistant (80 minutes).

**EMP 25453** (829608) 325 ml

**EMP 25458** (829387) 1 L

**F Kombat Insecticide**

30% DEET. 6 hours of effective protection. Strongest level of protection allowed in Canada. 200 g.

**EMP 90300** (562470)

**G OFF!® Deep Woods Aerosol**

Repels mosquitoes, ticks, biting flies, gnats and more. Non Greasy design. Effective protection up to 8 hours. 230 g.

**SJN 71944** (1061358)

**H OFF!® Family Care Spray**

Repels mosquitoes and other biting insects with a lower level of repellent ingredients. Non-greasy design. 175 ml.

**SJN 01938** (1061365)



**A Mouthwash**

Up to 5x longer fresh feeling breath vs when brushing alone. Contains Cetylpyridinium Chloride (CPC). Mint flavour. Travel size of 100 ml. Box of 18.  
**PGC 73627** (829161)



**B Crest Complete Whitening Toothpaste with Scope**

Kills bad breath bacteria. Minty fresh flavour. 20 ml travel size. Box of 36.  
**PGC 04550** (829163)

**C Anti-Dandruff Shampoo**

Paraben free. Clinically proven to help protect against flakes, itch, oil and dryness with regular use. Classic Clean scent. Travel size of 90 ml. Box of 24.  
**PGC 96701** (829191)



**D Hello Hydration Shampoo and Body Wash**

Paraben free, mineral oil free, dermatologist tested and certified cruelty free by PETA. Scented with coconut essences. Travel size of 44 ml. Box of 36.  
**PGC 00473** (829192)

**E Toothbrush**

Gentle end rounded bristles are specifically designed to be gentle on teeth and gums. Box of 72.  
**PGC 26140** (829206)



**F Ultra Moisture Body Wash**

Delivers long-lasting moisture to help treat dryness at the source. Lightweight formula gently cleanses to leave skin feeling smooth & looking healthy. 89 ml. Box of 54.  
**PGC 86410** (829207)



**G Collagen Body Lotion**

Nutrient-rich formula crafted with collagen. Created specifically to tighten and plump skin while diminishing fine lines. 502 ml. Sold by each.  
**PGC 20100** (829208)



**H Swagger Body Wash**

Transforms your skin to feel smooth and hydrated. 89 ml. Box of 24.  
**PGC 86423** (829209)



**I Swagger Antiperspirant Deodorant**

Provides strong protection against odor and wetness. Dries fast. 14 g. Box of 24.  
**PGC 1204404422** (829210)



**J Invisible Antiperspirant Deodorant**

pH-balanced protection. 24-hour, all-day protection. Baby powder scent. 14 g. Box of 24.  
**PGC 00188** (829212)





**A**



**A Mrs. Meyer's Hand Soap**

Free of phthalates, parabens, dea and sulphates. Ingredients of vegetable origin. 370 ml.  
**SJN 829837** (829837) lemon verbena  
**SJN 829839** (829839) basil  
**SJN 829838** (829838) lavender

**B Mrs. Meyer's Foaming Hand Soap**

Hardworking, nondrying foaming soap for busy hands and families. Made with essential oils, aloe vera, olive oil and other thoughtfully chosen ingredients. Cruelty-free formula is not tested on animals. 296 ml.  
**SJN 829840** (829840) apple  
**SJN 829841** (829841) watermelon

**C Foaming Hand Wash**

Antibacterial foaming hand soap. Gentle, non-drying formula. 221 ml.  
**DIA 2564518** (588038) power berries  
**DIA 2561183** (588152) coconut water/mango  
**DIA 2575890** (588137) spring water  
**DIA 2575964** (588129) pomegranate/tangerine



**B**



**C**

**D Néolia® Liquid Hand Soap**

Cleanses and moisturizes. Olive oil with aloe vera. 350 ml pump.  
**SUB 84012-1** (177246)

**E Néolia® Hand Soap Refill**

Cleanses and moisturizes. Olive oil with aloe vera. 750 ml refill.  
**SUB 84013** (520635)

**F Green Certified Foam Hand Cleaner**

A mild, biodegradable formula that is gentle on hands. EcoLogo certified. 222 ml.  
**GOJ 571506** (304162)



**D**



**E**



**F**





## A LTX-12™ Touch-Free Soap Dispenser

Reliable touch-free dispensing. Smart, trouble-free electronics eliminate battery changes in most installations. Large sight window. Refill not included. 1200 ml capacity. 6-3/4 x 4-1/4 x 10-1/2 in. Chrome/black.

GOJ 191904 (293928)

• 1200 ml refill - Pomeberry foam handwash

GOJ 1916-02 (558098) box 2

• 1200 ml refill - Clear & Mild foam handwash

GOJ 1911-02 (207290) by each



Touch-Free



A

## B LTX-7™ Touch-Free Soap Dispenser

Reliable touch-free dispensing. Smart, trouble-free electronics eliminate battery changes in most installations. Large sight window. Refill not included. 700 ml capacity. 6-3/4 x 4-1/4 x 8-1/2 in. Chrome/black.

GOJ 1388-04 (293936)

• 700 ml refill - Clear & Mild foam handwash

GOJ 1311-03 (293910) by each

## C FMX-20™ Manual Soap Dispenser

Push-style dispenser. Refill not included. 2000 ml capacity. 4-5/8 x 6-1/2 w x 11-5/8 po. Chrome/black.

GOJ 5271-06 (435446)

• 2000 ml refill - refreshing cranberry fragrance

GOJ 5261-02 (435412) box 2

## D ADX-12™ Manual Soap Dispenser

Push-style dispenser is ideal in high traffic areas. Large sight window. Refill not included. 1250 ml capacity. 4 x 4-5/8 x 12 in. Black and chrome.

GOJ 888806 (537472)

• 1200 ml refill - Clear & Mild foam handwash

GOJ 1911-02 (207290) by each

## E ADX-7™ Manual Soap Dispenser

Push-style dispenser is ideal in high traffic areas. Large sight window. Refill not included. 700 ml capacity. 12 x 4-5/8 x 4 in. Chrome/black.

GOJ 8788-06 (293845)

• 700 ml refill - Clear & Mild foam handwash

GOJ 8711-04 (293902) by each

• 1200 ml refill - Pomeberry foam handwash

GOJ 1916-02 (558098) box 2



Touch-Free



B



C



D



E



Touch-Free



**A** 



Touch-Free



**B** 

**A Autofoam Soap Dispensing System**

Touch-free dispensing system powered by light. Powered by the LumeCel™ rechargeable energy system. LumeCel's rechargeable energy cells and advanced solar panels make the AutoFoam dispenser completely self-powered by indoor or natural lighting. Featuring high quality foam soap in an attractive touch-free dispenser, this new system is now more efficient and does not rely on alkaline batteries.

- RUB 1980826** (431270)
- **Enriched foam soap refill - citrus**
- RUB F6750112** (431288)

**B ES8 Soap Dispenser**

Always-ready touch-free hand soap dispenser with energy-on-the-refill. Each new refill comes with its own energy source - a coin cell battery integrated into the refill. Dispenser and formulation are calibrated to provide the optimal dose for effective hand hygiene. Refill with Purell® ES8 1200 ml Health Soap® refills (sold separately).

- GOJ 7730-01** (598185)
- 1200 ml refill**
- GOJ 598227** (598227) mild foam
- GOJ 598235** (598235) high performance foam

**C Soap Dispenser**

Delivers more than 1700 handwashes. ADA compliant, one hand push operation. 1250 ml. White.

- GOJ 10495** (1060243)



**C** 



**D**

**D Soft Care® Hand, Hair And Body Wash**

Formula to clean your hands, hair and body with a lemon tea splash fragrance. Clean-rinsing soap is pH-balanced for an all-in-one wash that won't dry out your skin. It is free from undesirable ingredients, such as Cocamide DEA, parabens and triclosan. 3.78 L.

- DVO 100920026** (1073113)

**E Natural\*Orange™ Pumice Hand Cleaner**

Quick-acting lotion formula with pumice scrubbing particles for cleaning a broad range of industrial soils, medium dirt and grease. Orange citrus scent. 3.78 L.

- GOJ 0955-02** (259937)



**E** 

## A LTX-12™ Hand Sanitizer Dispenser

Touch-free dispensing. Smart, trouble-free electronics eliminate battery changes. Large sight window. No water or towels needed. 1,200 ml refill. Refill not included. 6-3/4 x 4-1/4 x 10-1/2 in.

### Dispenser

GOJ 1920-04 (284794) white

GOJ 1928-04 (549626) chrome/black

• 1200 ml refill - gel formula, 70% alcohol

GOJ 190302CAN (569848) box 2

• 1200 ml refill - Advanced moisturizing foam

GOJ 823906 (823906) box 2



A

## B LTX-7™ Hand Sanitizer Dispenser

Touch-free dispensing. Smart, trouble-free electronics eliminate battery changes. Large sight window. No water or towels needed. Refill not included. 700 ml refill. 6-3/4 x 4-1/4 x 8-1/2 in. White.

GOJ 1320-04 (294454)

• 700 ml refill - Advanced moisturizing foam

GOJ 294462 (294462) by each



B

## C ADX-7™ Hand Sanitizer Dispenser

Push-style dispenser is ideal in high traffic areas. Large sight window. Refill not included. 700 ml capacity. 4 x 3-5/8 x 9-5/8 in. White.

GOJ 8720-06 (294405)

• 700 ml refill - Advanced moisturizing foam

GOJ 294439 (294439) by each



C

## D TFX Hand Sanitizer Dispenser

Touch-free system dispensing system. 1200 ml high-capacity refill is sold separately. Level indicator window. Turns off automatically when open. Powered by 3 C batteries (not included). Refill not included. White.

GOJ 128231 (128231)

• 1200 ml refill - Advanced moisturizing foam

GOJ 122986 (122986)



D

## E ES8 Hand Sanitizer Dispenser

Always-ready touch-free hand soap dispenser with energy-on-the-refill. Each new refill comes with its own energy source - a coin cell battery integrated into the refill. Dispenser and formulation are calibrated to provide the optimal dose for effective hand hygiene. Refill with Purell® ES8 1200 ml Hand Sanitizer refills (sold separately).

GOJ 7720-01 (598193)

• 1200 ml refill - gel formula, 70% alcohol

GOJ 598219 (598219) box 2

• 1200 ml refill - Advanced moisturizing foam

GOJ 598201 (598201) box 2



E

## F Purell® Hand Sanitizer Dispenser

Push button. 1000 ml. Refill not included.

GOJ 2120-06 (743633)

• 1000 refill - 70% formulation (box 4)

GOJ 215608CAN (265744)



F



**A Electronic Touchless Skin Care Dispenser**

The Scott®Skin Care Dispenser System is designed to take hand hygiene to another level. You can count on its reliable, touchless operation to reduce cross-contamination and the spread of germs. It features a long battery life: up to 60,000 hand washes per 3 D-sized alkaline batteries. Plus, you'll enjoy easy maintenance with this smart system, including low battery and low product lights signal when replacements are needed. The keyed system helps protect your supplies from pilferage. The system is compatible with top skincare brands, including Kleenex® and Cottonelle Brands. 7.3 x 11.7 x 4 in.

- KCC 32499-01** (829897) white
- KCC 32504-01** (829898) black
- **1200 ml refill - moisturizing foam sanitizer (box 2)**
- KCC 91590** (829896)
- **Green certified foam skin cleanser refill (box 2)**
- KCC 91591-00** (829895)



**B Purell® Sanitizing Wipes**

Kills 99.9% of most common germs. Non-linting, textured surface removes soils and dirt. Fragrance free. Package of 100. **GOJ 902210CAN** (284562)



**C Purell® Hand Sanitizing Wipes**

Kills 99.9% of most common germs. Non-linting, textured surface removes soils and dirt. Fragrance free. Dispensing canister (holder not included). 80 wipes. **GOJ 903012CAN** (146258)



**D Purell® Hand Sanitizing Wipes**

Kills 99.9% of most common germs. Non-linting, textured surface removes soils and dirt. Fragrance free. Dispensing canister. 175 wipes. **GOJ 146266** (146266)

## A Hand Sanitizer

Kills 99.99% of most common germs. Use it anywhere, without water or towel. Fragrance free gel, 70% ethyl alcohol.

GOJ 965124CAN (779496) 118 ml  
GOJ 377012CAN (260323) 354 ml



## B Hand Sanitizer - Pocket Size

Kills 99.99% of most common germs. Use it anywhere, without water or towel. Fragrance free gel, 70% ethyl alcohol. 59 ml. Box of 24.

GOJ 965024CANS (828883)

## C Germ Buster Gel Hand Sanitizer 70%

Clear gel contains aloe, vitamin E, and additional moisturizers. Quickly dries without leaving any sticky residue, while safely and effectively killing harmful germs and bacteria.

EMP 01200 (562462) 60 ml  
EMP 01201 (504688) 120 ml  
EMP01202 (504696) 270 ml  
EMP01204 (504704) 540 ml  
EMP 01208 (504712) 1030 ml



## D Germ Buster Moisturizing Care Hand Sanitizer Lotion

Combines a moisturizing lotion with aloe, vitamin E and additional moisturizers, with our hand sanitizer formula, to keep hands soft and supple, while effectively killing germs and bacteria. 62% alcohol. 270 ml.

EMP 01232 (504779)

## E Hand Sanitizer Clear Gel

Kills harmful germs and bacteria. Fragrance free and dye free. 70% alcohol. 1 litre.

EMP 01217 (829603)

## F Advanced Foam Hand Rub

Fragrance-free, 70% ethyl alcohol foaming and moisturizing formula. Kills 99.99% of most common germs that may cause illness without soap and water. 535 ml dispenser.

GOJ 294413 (294413)

## G Moisturizing Instant Hand Sanitizer

Kill 99.9% of germs without the use of soap and water. 62% ethyl alcohol. Safe for indirect food contact use. Citrus scent. 18 oz / 532 ml.

KCC 45827 (570994)

## H Avagard™ D Instant Hand Antiseptic With Moisturizers

Provides fast, effective bacterial kill without being hard on skin. Dries quickly without leaving hands sticky. Uniquely formulated to be non-drying and non-irritating to skin, even with multiple daily use. Emollient-rich formulation helps prevent skin break down and has shown to improve hand hygiene compliance when included as part of a multi-dimensional program. Broad-spectrum activity kills 99.99% of harmful bacteria, including antibiotic-resistant strains. 500 ml.

MMM 9222C (348086)





**A** **PUR**  
value



**B** **Kleenex**

**A Pur Value® Facial Tissue**

2-ply. Box of 100 tissues. White.  
**VPU 102543** (207100)

**B 2-Ply White Facial Tissue**

Suitable for countertop or wall mounted dispensers. Case of 12 boxes, 125 tissues per box. White.  
**KCC 03076** (340315)

**C Cascades Pro Perform™ Facial Tissues**

2-ply. Box of 100 tissues. Moka. 100% recycled content.  
**CSD F300** (425272)

**D Puffs® Plus Lotion With The Scent of Vicks Facial Tissues**

Provides comfort to relieve a runny nose. The lotion contains shea butter, aloe, and vitamin E; the scent of Vicks contains eucalyptus, menthol, and camphor. 2-ply. 4 boxes of 124 tissues.  
**PGC 47927** (512954)

**E White Swan® Facial Tissue**

2-ply. 74 x 8.2 in. Case of 30 boxes of 100 tissues. White.  
**KRI 08301** (517078)

**F Facial Tissue**

2-ply. Box of 100 tissues. White.  
**KCC 21400** (567016)

**G Pro Select™ Facial Tissue**

2-ply. Box of 100 tissues. White. FSC certified.  
**CSD F950** (601211)

**H Anti-Viral Facial Tissue Cube Box**

Kills 99.9% of cold and flu viruses in the tissue within 15 minutes. 3-ply. 55 tissues per box.  
**KCC54552** (829415)

**I Two-Ply Facial Tissue**

Cube box of 85 tissues. Case of 36 boxes.  
**GJO 26085** (1062330)

**J Two-Ply Facial Tissue**

Flat box of 100 tissues. Case of 30 boxes.  
**GJO 26100** (1062348)



**C** **Cascades**



**D** **Puffs**



**E** **Kruger**



**F** **Kleenex**



**G** **Cascades**



**H** **Kleenex**



**I** **GENUINE JOE**



**J** **GENUINE JOE**



## A Tork® Universal Paper Towel

2-ply, 210 towels per roll. Box of 12. 100% recycled content.  
TRK HB1995A (293308)



## B Pro Select™ Kitchen Roll Towels

2-ply. Box of 30 rolls of 85 sheets. 100% recycled content,  
40% post-consumer waste.  
CSD K085 (426478)



## C White Swan® 2-Ply Paper Towels

The paper towels packs allow for easy product identification on shelf and are easy to carry. 70 sheets per roll. Package of 15 individually wrapped rolls. White.  
KRI 15702 (593970)

## D Embassy® 2-Ply Paper Towels

The paper towels packs allow for easy product identification on shelf and are easy to carry. 52 sheets per roll. Package of 15 individually wrapped rolls. White.  
KRI 10146 (593988)

## E SpongeTowels® Ultra Paper Towels

Choose a size. Package of 6 rolls of 88 sheets. 100% recycled content.  
KRI 53606 (594804)



## F Professional Paper Towels

Absorbent paper. 2-ply. 9 x 11 in. roll.  
KRI 01890 (684613)

## G Bounty Paper Towels

2-ply. 2X more absorbent. 11 in paper towel. 74 sheets per roll. White.  
PGC 65534 (829157) pkg 4  
PGC 79110 (829156) pkg 6  
PGC 79057 (829155) pkg 12

## H Kitchen Roll Towels

One-ply. 128 sheets per roll. White. FSC and Ecologo Certified.  
Minimum 40% post-consumer content.  
KCC 41482RL (1016120)



## I White Swan® Professional Paper Towels

Two-ply. 70 rolls per sheet. Package of 30. White. 100% recycled,  
at least 88% post-consumer content.  
KRI 01702 (1061399)



## J Household Roll Paper Towels

Two-ply. White.  
80 towels - 11 x 8-4/5 in. (box 30)  
GJO 24080 (1062587)  
85 towels - 11 x 9 in. (box 30)  
GJO 24085 (1062512)  
100 towels - 11 x 8-4/5 in. (box 24)  
GJO 24081 (1062496)  
250 towels - 11 x 8 in. (box 12)  
GJO 25012 (1062504)





**A**  **Cascades**



**B**  **Scott**

**A PRO™ Universal Mechanical No Touch Dispenser**

The universal no-touch roll towel dispenser reduces tabbing and controls release of paper. This dispenser handles all 8 inch Cascades PRO universal roll towels and has a stub roll feature to minimize waste. Black.

- CSD DH55** (425462)
- Hand towels (6 rolls)
- CSD H280** (425264) white
- CSD H285** (426742) natural

**B CONTROL™ Electronic Slimroll Dispensing System**

Contactless paper dispenser. Dispenses 10 in. towels. Made of plastic. Includes 4 D Cell batteries and a lifetime warranty when used with matching Scott Slimroll paper rolls. For 8 in. diameter rolls x 580 ft. long. 11.8 x 12.35 x 7.25 in. White.

- KCC 47259** (579904)
- Hand towels (6 rolls)
- KCC 47035** (579912) white

**C Tork Matic® Automatic Dispenser**

Hand towel dispenser with Intuition™ sensor gives your guests the ultimate no-touch hand drying experience. Adjustable towel length allows you to reduce towel consumption. Modern design. 33 x 20 x 37 cm. Black.

- TRK 5511282** (436071)
- Hand towels (6 rolls)
- TRK 290089** (293621) white
- TRK 290088** (293613) natural



**C**  **TORK**



**D**  **TORK**

**D Lever Auto-Transfer Hand Towel Dispenser**

Modern appearance. Translucent cover allows an "at-a-glance" inspection for refills. 13 x 9-1/4 x 15-1/2 in. Black.

- TRK 84TR** (294983)
- Hand towels (12 rolls)
- TRK RB350A** (1016062) white

**E Touchless Hardwound Towel Dispenser**

Solutions touchless hardwound towel. Uses only Genuine Joe Solutions hardwound roll (HR) towels. Black.

- GJO 99706** (1060251)
- Hand towels (6 rolls)
- GJO 96007** (1062455) white



**E**  **GENUINE JOE**



**F**  **FROST**

**F Frost 101 Hand Towel Dispenser**

Front access for easy maintenance and loading. Stainless steel construction with epoxy powder coating finish. Accept all standard single fold and 205 ft roll towels. 10-1/2 x 6-3/4 x 9-1/2 in. White.



**A Pur Econo Hand Towel Rolls**

8 in. x 600 ft. 1.75 in core. Box of 12.  
**VPU 101020** (429795) white  
**VPU 101018** (429480) kraft



**B Advanced Hand Towel Roll**

1-ply. Width of 7.87 in. Length: 600 ft. Box of 12. White.  
 100% recycled content.  
**TRK RB600** (294181)



**C Universal Hand Towel Roll**

1-ply. Width of 7.87 in. Length: 350 ft. Box of 12. White.  
 100% recycled content.  
**TRK RB351** (337451)

**D Cascades Pro Perform™ Hand Towels for Tandem®**

For Tandem® dispensers. 7.5 in x 775 ft. Box of 6 rolls.  
 100% recycled content.  
**CSD T114** (425256)

**E Metro Hand Towel Roll**

Central pull system. 2-ply. 8 in. x 600 ft. Box of 6. White.  
**KRI 01322** (525808)

**F Esteem® Universal Roll Hand Towels**

8 in x 205 ft. Box of 12. 100% recycled with at least  
 88% post-consumer content.  
**KRI 10183** (594002)

**G Durables Hardwound Roll Towels**

1-ply. 7.8 in wide. Kraft.  
**PTU DP0355** (827935) 350 ft. (box 12)  
**PTU DP0359** (827936) 800 ft. (box 6)



**E**



**F**



**G**





**A** Kleenex



**B** TORK



**A Hand Roll Towel**

Highly absorbent air pockets for quick hand drying. 1-ply. 1.75 in. core diameter. 8 in. x 600 ft. Box of 6. White. 50% recycled, 40% post-consumer content.  
**KCC 50606** (829893)

**B Tork Elevation® Hand Towel**

9 in x 590 ft. Box of 6. White. Ecologo Certified. 100% recycled content.  
**TRK 121201** (1016039)

**C Scott® Hard Roll Towels**

8 in x 400 ft. Box of 12. White. Minimum 40% post-consumer content. FSC and Ecologo Certified.  
**KCC 02068** (1016088)

**D Paper Towels**

You can pull the towels from different angles and only touch one towel at a time. Non-chlorine bleaching. 600 sheets per roll. 7.3 x 10 in. Box of 6. White.  
**GJO 23600** (1062421)

**E Hardwound Roll Towels**

2 in core size is compatible with most universal dispensers. 7-1/4 in x 350 ft. Box of 12. 100% recycled content, 40% post-consumer content.  
**GJO 22300** (1062488) white  
**GJO 22200** (1062413) natural



**C** Scott



**D** GENUINE JOE

**F Metro® Paper Roll Towels**

2 in core. 8 in. x 425 ft. Box of 12. 100% recycled, 88% post-consumer content.  
**ME0 01845** (1062520)



**E** GENUINE JOE



**F**



## A Interfold Towel Dispenser

Modern appearance. Translucent cover allows an "at-a-glance" inspection for refills. 11-3/4 x 6-1/4 x 18 in. Sold by each. Black.

**TRK 73TR** (295147)

• Hand towels (16 packs)

**TRK MK530A** (293365) natural



## B Universal Fold Towels

1-ply. Width: 10-1/4 in. Length: 9.13 in. Box of 16 packages of 250. 100% recycled content.

**TRK SA1840A** (337469) white

**TRK SK1850A** (293373) natural

## C Kleenex® Hand Towel

Super absorbant. 1-ply. Box of 120.

**KCC 01701** (792853)

## D Kleenex® Hand Towels

Multifold. Box of 8 packs. 150 sheets by pack.

**KCC 02046** (543637)

## E Essential Paper Towels

9.5 x 10.5 in. Box of 16 packs of 250 towels. White. Ecologo Certified. 60% recycled, 40% post-consumer content.

**KCC 01700** (1016055) singlefold

**KCC 01804** (1016112) multifold

## F Metro Single Fold Towels

1-ply. 9 x 9 in. Box of 16 packages of 250. Brown. 100% recycled content.

**MEO 01802** (543587)

## G Pur Econo Hand Towels

Package of 250 sheets. 9-1/4 x 10 in. Box of 16.

Singlefold

**VPUV05210** (829140) white

Multifold

**VPU 101377** (251090) kraft

**VPU 102542** (251363) white



## H Paper Towels

High quality, value priced towels that are ideal for all public environments. White. Minimum 40% post-consumer content.

Singlefold, 13 x 10 in. - 240 towels (box 10)

**GJO 21120** (1062397)

Multifold, 9.2 x 9.4 in. - 250 towels (box 16)

**GJO 21100** (1062546) =

## I Folded Towels

Chlorine-free. 16 boxes of 250. Ecologo Certified. Minimum 40% post-consumer content.

Singlefold - 10.3 x 9.1 in.

**GJO 21020** (1062611)

Multifold - 9.3 x 9.4 in.

**GJO 21040** (1062579)





**A** Cottonelle



**B** Scott

**A Bathroom Tissue**

Individually wrapped. 2-ply. 451 sheets per roll. Fits most standard bathroom tissue dispensers. Box of 60. 25% recycled content. FSC® certified.  
**KCC 17713-01** (829891)

**B Bathroom Tissue**

Individually wrapped. 2-ply. 550 sheets per roll. Fits most standard bathroom tissue dispensers. Box of 40. 100% recycled content. FSC® and EcoLogo certified.  
**KCC 48040** (829892)

**C White Swan® Bathroom Tissue**

4.2 in. wide sheet allows the roll to fit in most dispensers. 325 sheets. 2 ply. White. Package of 36 individually wrapped rolls. 100% recycled with at least 88% post-consumer content.  
**KRI 10325** (593996)

**D White Swan Bathroom Tissue**

2-ply. 48 rolls of 429 sheets. 100% recycled content, 20% post-consumer waste.  
**KRI 05144** (377374)

**E Toilet Paper**

Individually wrapped. 2-ply. Box of 48. 100% recycled content.  
**CSD 102047** (829584) 420 sheets/roll  
**CSD B042** (829585) 500 sheets/roll



**C** Kruger



**D** Kruger

**F Purex® Bathroom Tissue**

Quality two-ply. Hypoallergenic and dermatologist approved. Individually poly-wrapped. Made with 100% recycled fibre and at least 88% post-consumer content. 506 sheets per roll. Box of 60.  
**KRI 05705** (1062257)

**G Metro Bathroom Tissue**

Provides standard softness, absorbency, and strength. Made with 100% recycled fibre. 2-ply. 48 rolls of 500 sheets. White.  
**ME0 05485** (543538)



**E** Cascades



**F** Kruger



**G** Kruger

## A Charmin Ultra Soft Toilet Tissue

Cushiony soft without compromising strength. 2X more absorbent. FSC® certified.

PGC 01562 (833344) 8 rolls

PGC 01554 (829159) 20 rolls

## B Universal Jumbo Bathroom Tissue

Refill for Tork® dispenser. 2-ply. 1000 ft. Box of 12. White.

100% recycled, 20% post-consumer content.

BNZ 14100924 (293290)

## C Purex® Bathroom Tissue

2-ply. Refill for Tork® dispenser. Box of 8. 3.3 in. core. White. 1000 ft.

100% recycled content.

KRI 05620 (320077)

## D Chalet® Jumbo Bathroom Tissue

2-ply paper roll. 3.3 in. core compatible with most dispensers.

698 ft. Package of 8 rolls.

KRI 05994 (593954)

## E Metro® Jumbo Roll Bathroom Tissue

2-ply paper roll. 3.3 in. core. 1000 ft. Box of 12.

ME0 05112 (1059617)

## F Essential™ Jumbo Roll Bathroom Tissue

2-ply. Non-perforated. 3.55 in. x 1000 ft. Fits most universal

jumbo roll dispensers. Box of 12. 100% recycled content.

FSC® and ECOLOGO® certified.

KCC 67805 (829894)

## G Jumbo Bathroom Tissue

Two-ply. Contains minimum of 20% post-consumer materials.

Box of 12. White.

GJO 2565012 (1062363) 650 ft.

GJO 2510012 (1062356) 1000 ft.





**A** **TORK**



Holds 4 standard rolls



**B** **Kruger**



**A Elevation™ Bath Tissue Jumbo Mini Dispenser**

For 2 rolls. 17 x 5.7 x 10.1 in. Black.  
**TRK 555290** (295121)  
 • 2-ply toilet tissue - box of 8 rolls (751 ft.)  
**TRK 12024402** (293332)

**B Twin Bath Tissue Dispenser**

Holds two rolls of jumbo size bath tissue. Ideal for use in very high traffic areas. 20 x 5.4 x 2.8 in. Black.  
**KRI 09645** (1073121)  
 • 1-ply toilet tissue - box of 8 rolls (2000 ft.)  
**KRI 05611** (595934)  
 • 2-ply toilet tissue - box of 8 rolls (1000 ft.)  
**KRI 05662** (543546)

**C PRO Tandem™ Dispenser**

Touchless roll dispenser. Made of plastic. Jam-free. Key lock. Push button. 1-year limited warranty. 4-roll capacity. 16 x 5.50 x 14 in. Grey.  
**CSD C314** (823903)

**D PRO™ Toilet Paper Dispenser**

Transparent locking cover. Double roll. Grey.  
**CSD DB20** (594838)  
 • 2-ply toilet tissue - box of 48 rolls  
**CSD102047** (829584)

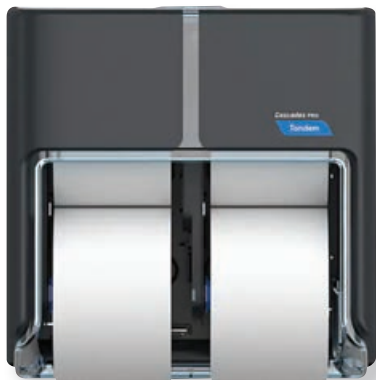

**C** **Cascades**



**D** **Cascades**



**E Bathroom Tissue Dispenser**

Single roll. Chrome.  
**FPL 146** (557892)

**F Toilet Seat Cover Dispenser**

Dispenser holds two boxes of Scott's Personal Seats disposable toilet seat covers. Fully enclosed and hygienic. Dispenses with a center dispensing lever and features a key lock to reduce pilferage. 17.5 x 3.25 x 13.25 in. White.  
**KCC 09505** (586206)  
 • Toilet seat covers - Box of 250  
**KCC 07410** (586214)

**G Tork® Toilet Seat Covers**

1/2" fold design and are easily dispensed. Package of 250. White.  
**TRK 14100109** (294249)



**E**



**F** **Scott**



**G** **TORK**

## A Non-Para Urinal Screen With Block

Screen with block and blue dye indicator. Water soluble that cleans and deodorizes up to 30 days. Natural odours counteractant and is water soluble. Strong sudsing action assure sanitation. Contains no para or acids. Box of 12. White.  
**GJO 58335** (1061282)



## B Scented Urinal Pucks

Cherry scent. Package of 12.  
**HOS 06311** (331587)



## C Tampax Regular Tampons

Single-size tubes for vending machines. Flushable and biodegradable. Box of 54.  
**PGC00826** (526210)



**B**



## D Always Infinity Radiant Women Sanitary Pads

100% leak & odor-free protection. Soft and flexible. Neutralizes odors for all day worry-free protection. With wings. Scented. Size 1, Regular Absorbency. Box of 18.  
**PGC 81829** (829154)

## E Toilet Plunger

Black.  
**PTU1150** (761445)



## F Plunger

Plunger with caddy. White.  
**MMM SB-PLNGR** (550186)

## G Toilet Brush with Caddy

Toilet brush for deep cleaning with convenient plastic caddy. White/blue.  
**MMM SB-TB** (545806)

**C** **TAMPAX**



**D** *always*

## H Toilet Brush

Toilet brush with plastic handle. Brush and support sold separately. White.  
**RUB FG631000WH** (527143) brush  
**RUB FG631100WH** (522805) holder

## I Dual Action Bowl Brush

Brush and support sold separately. White.  
**AGI 823** (761197) brush  
**AGI 816** (761205) holder



**E** **atlas graham**

**F** **Scotch-Brite**



**G**



**H**



**I**



**A**



**A Stratus® II Fragrance Metered Dispenser**

Emits a fresh burst of fragrance every 15 minutes. LED display. Use a D battery. White.

**Diffuser**  
**HOS 07521** (207217)

**7 oz refill**  
**HOS 070908** (207282) tropical tradewinds  
**HOS 07918** (207274) fresh linen  
**HOS 07932** (207258) fresh garden

**B**



**B TCELL™ Air Freshner Dispenser**

TCELL™ odour control system refills dispense a consistent level of high quality fragrance for up to 60 days. Easy to install and activate refill. Covers areas up to 6,000 cubic feet. Requires no batteries and operates silently. White.

**Diffuser**  
**RUB 1793547** (537621)

**48 ml refill**  
**RUB FG402113** (564732) citrus  
**RUBFG402369** (1014422) mango  
**RUBFG402470** (527135) cucumber melon  
**RUBFG402498** (340166) neutralizer

**C**



**C Automatic Room Spray**

Battery-operated unit time releases fragrance automatically, while a boost button provides more control with an instant burst fragrance any time you want. Starter kit includes a diffuser, scent refill and 2 batteries.

**Starter Kit**  
**SJN 70676** (1060706) clean linen

**175 g refill**  
**SJN 70602** (1060680) clean linen  
**SJN 70605** (1060698) hawaiian breeze

**D**



**D Microburst® 3000 Odour Control Refill**

Aerosol dispensing system maximizes odour control effectiveness for up to 168 days. Cucumber/melon scent.

**RUB FG750363** (371302)

**E**



**E Scented Air Freshener Spray**

Eliminates odours and freshens the air. 391 g.

**SJN 77048** (1060756) clean linen  
**SJN77044** (1060789) super fresh  
**SJN77045** (1060763) hawaiian breeze  
**SJN 77801** (1060771) lavender & vanilla

**F**



**F Febreze® Heavy Duty Air Freshener**

Cleans away odors with OdorClear™ Technology. Cleans away odors and freshens with a light, fresh scent. Use in entryways, lobbies, bathrooms, closets, or any room. 100% natural propellant. Scent: crisp clean. 250 g.

**PGC 96257** (829179)

**G**



**G Febreze® Gain Air Freshener**

Eliminates air odors without masking, leaving nothing behind but a light, fresh scent. Perfect for whole-home freshness with a 100% natural propellant.

**PGC 96252** (829178) by each  
**PGC 98517** (829177) pkg 2

**H**



**H Febreze® Air Freshener**

Eliminates air odors without masking, leaving nothing behind but a light, fresh scent. Perfect for whole-home freshness with a 100% natural propellant. Linen and sky scent. 500 g. Package of 2.

**PGC 98518** (829180)





## A Renuzit Gel Air Freshener

Adjustable cone air freshener. Great for continuous freshness in small spaces, such as bathrooms and closets. No outlets or batteries needed. Made with 98 % biodegradable gel. 198 g.

- DIA 2113071** (591032) after rain
- DIA 2113025** (591040) raspberry
- DIA 2113065** (591057) clean citrus
- DIA 2405594** (591065) Snuggly linen escape



**A**

## B brightair® Air Freshener

Safe to use around the home, office and any other areas you want to keep fresh. Freshens for up to 60 days. 14 oz/395 g.

- BRI 900248** (1060524) zesty lemon & lime
- BRI 900013** (1061340) mandarin orange & lemon
- BRI 900014** (1061332) lavender et fresh linen
- BRI 900090** (1061316) cool & clean
- BRI 900114** (1061324) island nectar & pineapple



**B**

## C Oil Warmer

Cleans away odors with OdorClear Technology. Freshens up to 45 days. Plug into any outlet to start cleaning away your tough odours in the kitchen, mudroom, or even pet odours. 26 ml.

- Starter kit**
- PGC 72811** (829187) linen & sky
- Package of 2 refills**
- PGC 46299** (829185) linen & sky
- PGC 81256** (829186) lavender

**B**

## D Plugins® Air Freshener

Long-lasting scent provides a continuous fragrance for up to 30 days. See-through bottle lets you quickly see the current level to prevent unexpected depletion.

- Starter kit**
- SJN 70900** (1067776) Hawaiian Breeze
- Package of 2 refills**
- SJN 70011** (1060730) Lavender & Vanilla
- SJN 80996** (1060722) Hawaiian Breeze



**C**

## E Small Spaces™ Air Freshener

Long-lasting freshness. Eliminates odors for up to 45 days. Great for small spaces: closets, bathroom, lobbies. No batteries and no plugs so you can put anywhere. 75 ml. Package of 2.

- PGC 55879** (829188) hawaiian aloha
- PGC 55286** (829189) gain
- PGC 55868** (829190) linen & sky

**C**

## F Car™ Vent Clips Air Freshener

Cleans away odors with OdorClear Technology. Slowly releases a light, fresh scent for up to 30 days. Attaches easily to car vent and allows you to select the level of intensity to control how much freshness is released. Package of 2.

- PGC 01107** (829181) hawaiian aloha
- PGC 01052** (829182) linen & sky
- PGC 01053** (829183) midnight storm

**D**

## G Fabric Refresher

Cleans away odors from fabrics that you wish you could wash with OdorClear Technology, leaving your fabrics with a light, fresh scent. 800 ml.

- PGC 97584** (829184) original scent
- PGC35218** (512731) antibacterial

**E**



**F**



**G**

# TruSens™

## PERFORMANCE SERIES AIR PURIFIERS



©2022 ACCO Brands. All Rights Reserved. C125\_22\_P



**MORE POWER  
WHERE YOU NEED IT**



**REDUCES  
AIRBORNE VIRUS EXPOSURE**



**SAVE  
WHERE IT COUNTS**

- Complete room coverage up to 2,000 sq. ft.\*
- Enhanced SensorPod™ with real-time feedback
- 4 levels of protection including True HEPA filtration
- No installation required

\*AHAM uses 4.84 air changes per hour, so AHAM values are slightly different.

## A Air Purifier

Technologically advanced air purifier with DuPont filtration reduces pollutants in your personal space and improves your home air quality. The sleek design and compact style are ideal for any small space. PureDirect technology distributes air more comfortably and effectively. This proprietary technology uses two airflow streams, distributing air further and more evenly throughout your room. 360-degree DuPont HEPA filter captures pollutants and VOC gases/odors from all directions. UV light reduces germs and bacteria that can get trapped in the filter. Simple touch-button control of fan speed, UV mode, and filter replacement indicators. Contemporary design that complements any home environment. Portability is easy with the sleek, integrated handle. 2-year warranty.

**Z-1000 - for 250 square feet**  
**TSE Z1000AP** (823492)

**Z-2000 - for 375 square feet**  
**TSE Z2000AP** (823500)

**Z-3000 - for 750 square feet**  
**TSE Z3000AP** (823518)

• **DuPont carbon layer replacement - package of 3**

**TSE AFCZ100001** (823435) for Z-1000

**TSE AFCZ200001** (823443) for Z-2000

**TSE AFCZ300001** (823450) for Z-3000

• **DuPont replacement filter 3-in-1 HEPA drum**

**TSE AFHZ100001** (823468) for Z-1000

**TSE AFHZ200001** (823476) for Z-2000

**TSE AFHZ300001** (823484) for Z-3000



**A** TruSens

## B Performance Series Air Purifier

Recommended for large professional and educational spaces like classrooms, offices, conference rooms, and more. Effective solution against airborne allergens, bacteria, viruses, and more. Effective at completely replacing the air every thirty minutes.

**Z-6000 - for 1750 square feet**  
**TSE Z6000AP** (829500)

**Z-7000 - for 2000 square feet**  
**TSE Z7000AP** (829501)

• **Package of 2 HEPA replacement filters**

**TSE 829483** (829483) for Z-6000

**TSE 829484** (829484) for Z-7000



**B** TruSens

## C AeraMax® Air Purifier

4-stage hospital-type filtration. Detects air quality and automatically adjusts the fan speed to keep your air purified. True HEPA filter with antimicrobial treatment safely removes 99.97% of airborne particles as small as 0.3 microns, including allergens, viruses, and cigarette smoke. Proven to capture the airborne flu virus. Carbon filter removes odors and captures large airborne particulates. Aera+™ Mode for allergy and cold/flu seasons. Also features AeraSmart Sensor and PlasmaTrue™ Technology. Ultra-quiet operation. AHAM and CARB certified. UL Listed. 3 year limited warranty.

**AeraMax® 90/100 for 100 - 200 square feet**

**FEL 9286001** (245639) blanc

**FEL9320301** (809624) white

**AeraMax® 190/200 for 200 - 400 square feet**

**FEL9286101** (245647) black

**FEL 9320401** (809608) white

**AeraMax® 290/300 for 300 - 600 square feet**

**FEL 9286201** (245654) noir

**FEL9320501** (809616) white

• **HEPA filter**

**FEL 9287004** (245662) AeraMax® 90/100

**FEL 9287104** (245670) AeraMax® 190/200

**FEL 9287204** (245688) AeraMax® 290/300

• **Carbon filter - package of 4**

**FEL 9324004** (809640) AeraMax® 90/100

**FEL 9324104** (809657) AeraMax® 190/200

**FEL 9324204** (809665) AeraMax® 290/300



**C** Fellowes

## D Medium Ultrasonic Humidifier

High-capacity tank. Long lasting water softening filter helps minimize white dust. Simply fill the tank and get up to 50 hours of quiet operation. 3-year limited warranty. White.

**TSE N200H** (829556) medium - 5 L

**TSE N300H** (829557) large - 8 L

• **Aromatherapy pads - package of 10**

**TSE ATP300-01** (829555)

• **Replacement filter**

**TSE WSF300-01** (829558)



**D** TruSens



**A**



**B**



**C**



**D**



**E**



**F**



**G**



**H**

**A DFN-15 2-in-1 Fan**

Offers the versatility of both a clip-on fan and compact desk fan. The 6 in clip-on fan conveniently snaps into base, to convert it into a desk fan. 2 speeds. 7.7 x 8.3 x 11.8 in. White.  
**RSI DFN-15** (430280)

**B DFN-30B Oscillating Fan**

Tilt-adjustable fan head. Coated safety grill. Wide angle oscillation. 3 speed settings. 12 in. White.  
**RSI DFN-30B** (347245)

**C PFN-40B Pedestal Fan**

Epoxy-coated security grill. Adjustable angle and height. Oscillating control. Quiet operation. 3 speeds. 16 in. White.  
**RSI PFN-40B** (360834)

**D PFN-48B Oscillating Pedestal Fan**

Quiet operation. Wide angle. Adjustable tilt and height. Built-in timer option. Auto shut off timer after 2 hours. Use with remote control or control panel. Heavy duty round sturdy base. Easy assembly requires no tools. cETL certified. 3 speeds. 18 in. Black.  
**RSI PFN-48B** (828297)

**E HCE-160 Oscillating Ceramic Heater**

PTC heating element. Two heat settings: 750/1500 watts. Adjustable thermostat. Overheating protection. Tip-over protection. Power indicator light. 7.87 x 5.91 x 10.24. Silver/grey.  
**RSI HCE-160** (368571)

**F HFN-03 Portable Fan Heater**

This convenient, economical space ceramic heater has 2 adjustable heat settings (750-1500W) and an adjustable thermostat. 8.75 x 7.8 x 11.75 in. White.  
**RSI HFN-03** (428292)

**G HCE-100 Ceramic Heater**

Ceramic element. Adjustable thermostat with two heat settings: 750W, 1500W. Cool, warm, hot mode selection. Quiet heat or fan-only settings. Automatic temperature control. Overheat protection and safety tip-over switch. 7.1 x 5.5 x 8.3 in.  
**RSI HCE-100** (511295)

**H HUT-80 Heavy Duty Utility Heater**

Durable construction with metal body and base. 2 heat settings: 750/1500W. Long life safe PTC (ceramic) heating element. Auto-reset safety limit shuts heater off in the event of overheating and resets after cooldown. Fast 3 second heat generation. Manual adjustable thermostat. Fan only setting. Power light indicator. Large angle tilt adjustable. Built-in handle and large support legs. cETL certified. 8.6 x 8.7 x 10.3 in.  
**RSI HUT-80** (1003391)

## A Oxivir® Tb Disinfectant Wipes

Ready-to-use disinfectant cleaner based on proprietary hydrogen peroxide (AHP®) technology to deliver fast, effective cleaning performance. Disinfects in 60 seconds.

**SEL 5995422** (372474) pkg 60  
**DV05144708** (528919) pkg 160



**A**

## B Disinfecting Wipes

Kills 99.9% of viruses and bacteria, such as cold and flu viruses, Staph, Strep, E.coli, Salmonella and Listeria. Works on a variety of surfaces. Fights kitchen grease and soap scum.

**Fresh scent**

**CLO 01602PAK2** (522490) pkg 35  
**CLO 01609** (827799) pkg 75

**Lemon**

**CLO 01603PAK2** (529917) pkg 35  
**CLO 01608** (827800) pkg 75



**B**



## C Scott® 24-Hour Sanitizing Wipes

Maintains a sanitized surface for 24 hours. Eliminates more than 99.9% of bacteria, viruses and germs. Kills more than 99.9% cold and flu viruses. Eliminates bacterial and mold/mildew odours at the source. Prevents mold & mildew on hard surfaces for 7 days. Cuts through common grease, dirt, and grime. Bleach free formula, no rinsing required. Package of 75 wipes.

**KCC 53686** (827839)



**C**



## D Mr. Clean Disinfecting Wipes

Kills 99.9% of bacteria and viruses including the flu virus. Use on washable hard, nonporous surfaces such as appliances, counters, sinks, stovetops, toilet seats, doorknobs, & bathroom sinks. Citrus scent.

**PGC 04732** (829204) box 35  
**PGC 08575** (829205) box 75



**D**



## E Disinfecting Wipes

Kills SARS-CoV-2. Kills 99.99% of bacteria and viruses. Kills Flu virus. Disinfects, sanitizes and deodorizes in one step. Safe on stainless steel, glass, porcelain and plastics. Fresh citrus scent.

**EMP 01861** (829605) pkg 100  
**EMP 01862** (829606) pkg 800



**E**



## F GreenWorks™ Cleaning Wipes

Safe around kids, pets, and food. Cleans without harsh chemicals or fumes. Bleach-free. Plant-based cloth. Package of 75 wipes.

**CLO 55872** (829657) lemon  
**CLO 55873** (829658) unscented



**F**



## G All Purpose Cleaning Wipes

Quick, easy cleanup of phones and office equipment. Soft non-abrasive, non-toxic wipes come in convenient dispenser tub. Package of 100.

**GJO 49870** (1062843)



**G**



## H Disinfecting Wipes

Kills 99.99% of viruses and bacteria. Citrus scent. Package of 80.

**RAC CB99826** (833325)



**H**





**A**



**B**

**A Mrs. Meyer's Clean Day Multi-Surface Everyday Cleaner**  
Quick and easy multi surface spray removes stuck on dirt. Cruelty-free. 473 ml.  
S/N 829845 (829845) lemon verbena  
S/N 829847 (829847) basil  
S/N 829846 (829846) lavender

**B Mr. Clean Cleaning Mist**  
Lemon zest scent. 473 ml.  
PGC 79129 (829201) spray bottle  
PGC 79130 (829200) refill

**C Windex® Multi-Surface Cleaner**  
Antibacterial. Disinfectant. 765 ml.  
S/N 81772 (169797)

**D Pledge pH Balanced Multi-Surface Cleaner**  
Fresh citrus. 750 ml.  
S/N 336810 (829331)



**C**



**D**



**E**

**E Pine-Sol Multi-Surface Cleaner Disinfectant**  
Biodegradable and phosphate-free.  
1,41 liters  
CLO 40154FRM2 (522532) pine  
CLO50225 (458133) lemon fresh  
4.25 liters  
CLO 01166PK01 (293688) pine

**F Simple Green® Industrial All-Purpose Cleaner and Degreaser**  
Non-toxic, non-abrasive and non-corrosive.  
Spray bottle  
SMP 13012 (1059857) 710 ml  
Refill  
SMP 13005 (1059849) 3.78 L  
SMP 13006 (1059864) 18.9 L



**F**



**G**

**G GreenWorks™ All-Purpose Cleaner**  
97% naturally derived. Bleach-free. 946 ml.  
CLO 55868 (829654)

**H Stride® Neutral Cleaner**  
Neutral pH formulation that does not require rinsing and dries film-free.  
3.78 L. Citrus.  
DVO 903904 (829360)

**I Atomic All-Purpose Cleaner**  
General-purpose cleaner for household and institutional use. 3.78 L.  
AVM 101106661 (829383)

**J EcoPure Degreaser Cleaner**  
Quickly and effectively removes grease, oily residue, carbon ink, petroleum and spot from washable surfaces. 3.78 L.  
AVM 101106667 (829404)



**H**



**I**



**J**



**K**

**K Mr. Clean® Multi-Surface Cleaner**  
Kills 99.9% of bacteria. Summer citrus.  
PGC77131 (594143) 1.3 liters  
PGC31504 (260729) 3.78 liters

## A Disinfecting Mist Trigger

Kills 99.9% of bacteria and viruses. 473 ml. Lemongrass mandarin.  
**CLO 55854** (829655) spray bottle  
**CLO 55853** (829656) refill

## B All Purpose Disinfecting Cleaner Spray

The antibacterial formula quickly cuts through grease and grime and disinfects as you wipe, killing 99.9% of bacteria. 946 ml.  
**CLO 01401** (457044)

## C 4 in 1 Cleaner

Removes dirt and cuts grease. Lemon. 650 ml.  
**RAC 75227** (293969)

## D 3 in 1 Cleaner

Disinfecting all purpose spray and glass cleaner. Ready to use. 945 ml.  
**PGC00639** (728709)

## E Multi-Surface Heavy-Duty Degreaser

Great for tough buildup on surfaces. Ready-to-use.  
**PGC 02703** (829168) 946 ml  
**PGC 02702** (829167) 2.64 L

## F Disinfectant Spray

Kills 99.9% of fungi, viruses and bacteria Sanitize soft surfaces and prevents mould and mildew. Fresh linen. 350 g.  
**RAC CB340525** (779959)

## G Fantastick® Pro All Purpose Cleaner

Just spray and wipe, no rinsing required.  
**SJN 311837** (827791) 946 ml  
**SJN 311929** (809558) 3,8 L

## H Sanitizing Spray

Keeps surfaces sanitized for up to 24 hours. Keeps killing 99.9% of bacteria and germs.  
**79 g**  
**PGC 28079** (829194) agrumes  
**354 g**  
**PGC 48688** (829195) citrus  
**PGC 48774** (829196) fresh

## I Multi-Purpose Cleaner

24-hour sanitization against bacteria even after multiple touches. Kills 99.9% of bacteria in five minutes, and keeps killing for 24 hours. Citrus. 32 oz.  
**PGC 47415** (829198)

## J Surface Disinfecting Spray

Kills 99.99% of viruses and bacteria, including SARS-CoV2. Disinfects, sanitizes and deodorizes. 400 ml.  
**EMP 01860** (829604)

## K Pledge® Multi Surface Disinfectant Cleaner

Kills 99.9 percent of germs including the flu virus, staph, salmonella and more. Citrus. 275 g.  
**SJN 70688** (1061415)



**A**



**A Washroom Cleaner**

Non-abrasive. 945 ml.  
**Disinfectant**  
**PGC35021** (512491) 945 ml  
**With bleach**  
**PGC10909** (512400) 945 ml  
**PGC 99927** (829162) 3.78 L

**B**



**B Tilex® Mold and Mildew Remover**

Kills common household mold, mildew. 946 ml.  
**CLO 12438PAK3** (522516)

**C**



**C 24 Hour Bathroom Cleaner**

Helps prevent the growth of mold and mildew for 7 days on hard surfaces. Eliminates odours. 946 ml.  
**PGC 48590** (829197)

**D Bathroom Cleaner**

For daily use. Ready to use. 946 ml.  
**GJO 99668** (1059823)

**E Scrubbing Bubbles® Disinfectant**

Kills 99.9% of viruses and bacteria. 623 g.  
**SJN 73363** (1061936)

**F Comet® Deodorizing Cleanser With Chlorinol Plus**

Bleaches tough stains and deodorizes as it cleans. 400 g.  
**PGC04967** (512871)

**D**



**G Clorox Disinfecting Toilet Cleaner**

Disinfecting toilet bowl cleaner with bleach, kills 99.9% of germs. 709 ml. Sold by each.  
**CLO 01007** (458216)

**E**



**H Lysol® Toilet Bowl Cleaner With Bleach**

The angled bottle targets hard-to-reach areas, including under the rim, leaving your entire toilet bowl sparkling clean, deodorized, and disinfected. 710 ml.  
**RAC CB267115** (601203)

**I 2000 Flushes® Automatic Toilet Bowl Cleaner**

Kills 99.9% of bacteria without scrubbing. Clean and deodorize for up to four months.  
**WDF 90102** (1015454) blue + bleach  
**WDF 90615** (1015461) bleach

**F**



**J Scrubbing Bubbles® Toilet Bowl Cleaner**

Removes rust and destroys 100% of lime scale. 710 ml.  
**SJN 73542** (1061928) extra power  
**SJN 73541** (1061944) bleach gel

**G**



**H**



**I**



**J**





## A Glass Cleaner

Ammonia fortified. Extra-strength. Not suitable for tinted windows. 517 g.  
**EMP 44003** (537761)



## B Emzone Glass Cleaner

Foaming glass cleaner. Ammonia-free. Suitable to be used on tinted windows. 517 g.  
**EMP 44005** (553131) no ammonia



## C Windex PRO Foaming Glass Cleaner

With Ammonia-D. 560 g.  
**SJN 333813** (827994)



## D Windex® Glass Cleaner

With ammonia. Contains no phosphates.  
**SJN 322338** (827790) 946 ml  
**SJN 00672** (743229) 5 litres



## E Ammoniated Glass Cleaner

Spray bottle. 946 ml.  
**GJO 99669** (1059898)

## F Glass Cleaner and Protector Ready-to-Use

Non-ammoniated formula is fast-drying and non-streaking. 946ml.  
**MMM CGLASSCLNR** (829448)



## G Pledge® Furniture Polish

Aerosol can. For sealed wood, leather, sealed granite, stainless steel. Lemon.  
**SJN 184499** (184499) 275 g  
**SJN 00258** (1061423) 403 g



## H Twinkle Stainless Steel Cleaner and Polish

For stainless steel, brass, aluminum and chrome. 482 g.  
**DVO 991224** (523654)



## I Gum and Adhesive Remover

The natural solvents are very effective at removing oily stain, gum and adhesives. 473 ml.  
**GJO 99682** (1063255)





**A Tide® to Go Stain Pen**

Removes some of the toughest fresh food and drink stains.  
**PGC 01870** (779660) by each  
**PGC01871** (512343) pkg 3

**B Liquid Detergent**

Original scent. 48 loads. 2.04 L.  
**PGC 40215** (829221)

**C Tide Pods® Laundry Detergent Packs**

3-in-1 solution consisting of a detergent, a stain remover and a shine enhancer in one product. Dissolves quickly in traditional, front-loading and high efficiency washers.

**Package of 72**  
**PGC50978** (512970) spring meadow

**Package of 81**  
**PGC 93045** (513044) original  
**PGC91781** (513028) spring meadow  
**PGC91798** (513036) free and gentle



**D Tide Pods® Laundry Detergent Packs**

3-in-1 solution consisting of a detergent, a stain remover and a shine enhancer in one product. Dissolves quickly in traditional, front-loading and high efficiency washers. Package of 31.

**PGC 93037** (829223) original  
**PGC 93830** (829222) free and gentle

**E Laundry Detergent Powder**

Product contains Borax powder. 40 lb.  
**GJO 99737** (1060169)

**F Fabric Softener**

120 loads. April fresh scent. 3.06 L.  
**PGC 31220** (829176)

**G Dryer Sheets**

Softens fabrics, provides long-lasting freshness and reduces wrinkles. Outdoor fresh scent. Box of 200.  
**PGC30420** (512467)



**H Lavo Liquid Bleach**

6%. 3.6 L.  
**LVO 440154** (827683)



**A Scotchgard™ Carpet and Upholstery Cleaner**

With Scotchgard® protection. Removes tough stains, even in high traffic areas. 283 g.  
**MMM SGC-FC** (198986)



**A** **3M**

**B Spot Shot® Carpet Stain Remover**

Stain remover is safe for pets, children and the environment. 650 ml.  
**WDF 00914** (1015628)



**B**

**C Bissell® Professional Formula**

Concentrated carpet shampoo. Contains Scotchgard® to help protect carpets from future stains. 48 oz.  
**BIS 78H6Y** (1015602)

**D Floor Cleaner**

Liquid concentrate.  
**PGC 02011** (829211) 85 ml (box 48)  
**PGC 02001** (743294) 3.78 L (by each)



**C** **bissell**

**E Mr. Clean Finished Floor Cleaner**

Commercial use. Concentrated. 3.78 L.  
**PGC 03287** (829199)

**F Neutral Floor Cleaner**

Concentrated liquid. 946 ml.  
**GJO 99671** (1059930)

**G WD-40® Lubricant**

Features a multipurpose formula to provide thousands of uses.  
**WDF 01005** (1015511) 155 g  
**WDF 01011** (1015529) 311 g

**H Cliff® Floor Sweeping Powder**

For all unwaxed wood, metal and concrete floors. 20 kg.  
**FOD 1896471919** (348052)



**D** **Spic Span**



**E** **Mr. Clean M.Net**



**F** **GENUINE JOE**



**G**



**H**



**A**



**B** **IVORY**

**A Mrs. Meyer's Dish Soap**

Biodegradable formula. Contains plant-derived degreasers. Cruelty-free formula is not tested on animals. 473 ml.  
**SJN 829842** (829842) lemon verbena  
**SJN 829844** (829844) basil  
**SJN 829843** (829843) lavender

**B Ivory Ultra Concentrated Dishwashing Liquid**

Cuts through grease et is gentle on your hands. Classic scent. 1.02 L.  
**PGC 00863** (829193)

**C Dishwashing Liquid**

Powerful formula for sparkling dishes, pots and pans. 473 ml.  
**473 ml**  
**PGC00614** (829173) original  
**PGC00604** (829174) orange  
**PGC00602** (829175) apple  
**PGC00616** (829171) lemon  
**2.64 L**  
**PGC 00865** (829172) original



**C**



**D Sunlight Standard Dishwashing Liquid**

Classic formula that combines tough grease-fighting action with an invigorating lemon fresh scent.  
**DIA 2458283** (588079) 800 ml  
**DIA 2447657** (588061) 4.2 L

**E Ultra Sunlight Dishwashing Liquid**

Antibacterial that kills 99.9% of E.coli, Staph.aureus and salmonella bacteria. 562 ml.  
**DIA 2457633** (588095) orange  
**DIA 2457632** (588087) apple



**D**



**E**

**F Platinum Powerwash Spray Dish Soap**

Foam. Biodegradable. Reusable sprayer. Fresh scent. 473 ml.  
**PGC 52364** (829165) spray bottle  
**PGC 52366** (829164) refill

**G EZ-Squeeze Platinum Dishwashing Soap**

No mess cap. Refreshing rain scent. 366 ml.  
**PGC 01025** (829166)



**F**



**G**



**H Pot and Pan Detergent**

Ready-to-use. Formulated to power through tough commercial kitchen grease. Original scent.  
**PGC 03024** (829170) 1.12 L  
**PGC 03027** (829169) 3.78 L

**I Dishwashing Liquid**

Ideal for cleaning pots, pans and dishes. Leaves surfaces spot-free and film-free. Lemon scent.  
**GJO 99675** (1060185) 1.12 L  
**GJO 10359** (1062033) 3.78 L



**H**



**I**



**J**

**J EcoPure Liquid Dish Detergent**

Ideal for industrial and institutional use. No phosphates. No EDTA/NTA. No added fragrance. No VOC's. 946 ml.  
**AVM 10116715** (829405)

## A Dishwasher Detergent

Fresh scent. 1.7 kg.  
**PGC34035** (729228)



## B Cascade Complete® Action Pacs®

Formulated with the grease-fighting power of Dawn®. Rinse aid action with Shine Shield™ formula rinses away residue and leaves a brilliant shine. Safe to use on all dishwasher-safe dishes. Fresh scent. Package of 72.  
**PGC55439** (512996)



## C Cascade 2-in-1 Action Pacs® Dishwasher Detergent

The scrubbing power of Cascade with the grease-fighting power of Dawn®.

Fresh scent  
**PGC98082** (512848) pkg 25  
**PGC23780** (294389) pkg 90  
 Lemon  
**PGC98120** (513077) pkg 90



## D Quantum® Automatic Dishwasher Detergent

Washes away residue for an amazing shine, even in the hardest water conditions. Package of 45.  
**RAC CB940858** (595348)



## E Platinum Dishwasher Detergent ActionPacs

50% more cleaning power. Fresh scent.  
**PGC 96445** (829158) pkg 39  
**PGC89329** (512806) pkg 60

## F Dishwasher Rinse Agent

The rinse agent activates automatically with each rinse cycle, so you only need to refill it once a month (or as needed). 300 wash cycles. Original fragrance. 901 ml.  
**PGC89629** (512582)



## G Jet-Dry® Rinse Agent

It works with your dishwashing detergent to rinse away stubborn leftover food, spots, and film for sparkling dishes, glasses and utensils. 621 ml.  
**RAC CB769247** (595330)



## H Liquid-Plumr® Drain Clog Remover

Pours through standing waters. Safe for pipes. Not for toilet. 2.3 L  
**CLO 01165PK01** (458208) 2.37 L

## I Drano® Max Gel Clog Remover

Safe for use on both metal and plastics pipes. 900 ml.  
**SJN 00723** (1059963)

## J Drano® Clog Remover

Granules. Will not upset bacterial action in septic tanks. 500 g.  
**SJN 65588** (1060300)

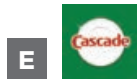

**G**

**H**



**I**

**J**



**A Magic Eraser**

Erases marks on walls, floors, etc. Powerful multi-purpose cleaning with water alone.  
**PGC04249** (512368) pkg 2  
**PGC82038** (294298) pkg 4  
**PAG16449** (512905) pkg 30

**B Handy Sponges**

Tough, strong and versatile. Cellulose sponge. Long-lasting alternative to paper towel. Package of 4.  
**MMM HP4-9** (559351)

**C Scrub Sponge**

Quickly cleans the toughest burnt on, dried-on foods from pots and pans. Resists odours.

**No scratch**

**MMM MP-3-12-CA** (190678) pkg 3

**MMM NS1212CA** (829439) pkg 12

**Heavy-duty**

**MMM HD-3-12-CA** (190660) pkg 3

**MMM SB-HD12-CA** (829451) pkg 12



**D Scrub Dots Sponges**

Scrub dots cut through stuck-on messes. Sanitize in the dishwasher and re-use. Package of 3.

**MMM 2030312CA** (1015388) non-scratch

**MMM 3030312CA** (1015370) heavy-duty

**E Greener Clean Scrub Sponge**

55% (by weight) of scrub sponge made using materials originating from plants. Package of 3.

**MMM 97033-CA** (829442) everyday cleaning

**MMM 87033-CA** (829443) heavy-duty



**F Scour Pads**

Non woven material won't tear, fray or rust. Package of 4.

**MMM SB4622** (187666) no scratch

**MMM SB411** (187633) heavy-duty

**G Heavy-Duty Dishwand**

Contoured shaped cleaning head easily gets into corners. Handle holds your favorite soap. Refillable. 8 in long.

**MMM 650-12-RRP** (780080)

• Package of 2 refill sponges

**MMM 187641** (187641) no scratch

**MMM SB481-CA** (206029) heavy-duty

**H Dish Brush**

For dishes, pots and pans. Rubberized handle.

**MMM 496P-8-CA** (191734)

**I Bottle Scrubber**

Slim scrubber with flexible tip. Fits most bottles, carafes and vases. Plastic handle, non-scratch poly fibre, safe to use on glass, stainless steel and plastic.

**MMM 507** (829444)

**J S.O.S.® Steel Wool Soap Pads**

Box of 18.  
**CLO 01177** (169763)



**A Magic Eraser Sheets**

Erases marks on walls, floors, light switches, doors and more.  
**PGC 08420** (829202) box 8  
**PGC 02791** (829203) box 16



**B Microfibre Kitchen Cloths**

Super absorbent polyester blend, non-scratching, quick drying.  
 Effectively removes dust, dirt and grease. Machine washable.  
 11.4 x 12.2 in. Package of 2.  
**MMM 9032-2CA** (829445)



**C Degreaser Wipes**

Pre-moistened disposable wipes with Scotchgard™ Protector. Helps  
 remove dirt and grease on stainless steel and anodized aluminum  
 surfaces. 12 x 9 in. Box of 30.  
**MMM SS-WIPES** (829446)



**D J-Cloth**

Durable and absorbent and washable. Antimicrobial protection.  
 12 x 19 in. Blue.  
**UNS 106059** (549568) pkg 8  
**FOD 77081** (319665) pkg 16



**E Microfiber Cloth**

For light commercial use. 12 x 12 in. Package of 24.  
**RUB 1820579** (437152) blue  
**RUB 1820577** (437343) pink  
**RUB 1820578** (437376) green  
**RUB 1820580** (437160) yellow



**F High Performance Microfibre Cloth**

For intensive use. Can be used dry, damp or wet or without detergent.  
 Package of 5. Blue.  
**MMM SB-2010B** (148650)

**G WypAll® Critical Clean  
 Foodservice Cloths**

Strong enough for extended use, and can be machine washed, rinsed  
 and reused. Features an antimicrobial Treatment, which inhibits the  
 growth of odour-causing bacteria. White. Box of 150. FSC® certified.  
**KCC 06280** (827891)

**H WypAll® X60 Multi-Task Cleaning Cloths**

absorbent and reinforced to stay strong for cleaning performance  
 in light duty tasks; they absorb water faster than rags. Pop-up box.  
 White.  
**KCC 34790** (146175) box 126  
**KCC 54015** (1014596) box 252



**I WypAll® X70 Medium Duty Cloths**

Durable, absorbent rags that stay strong for better cleaning  
 performance. Reusable. Cleans oil, grime, and solvents. 9.1 x 16.8 in.  
 Pop-up box of 100. White.  
**KCC 41455** (670109)



**J WypAll® X80 Heavy Duty Cloths**

Disposable cloths clean oil, dirt, grime and solvents, while  
 remaining resistant to harsh cleaning agents. Box of 160. Blue.  
**KCC 41041** (760959)





**A** **Hamilton Beach**

**A Durathon® Steam Iron**

Non-stick soleplate. Automatic stop with position sensor. Adjustable steam jet. Retractable cord at the touch of a button. Self-cleaning system. 5-year limited warranty.  
**HMB 19701** (829672)



**B** **atlas graham**

**B Wooly Wonder Super Flex Duster**

32 to 60 in long.  
**AGI 310** (207183)

**C Swiffer® 360° Dusters Extender™**

Extends up to 3 feet to reach dust in hard-to-reach places. Starter kit includes 1 handle and 3 dusters.

**Starter Kit**  
**PGC44750** (360735)  
**Refills dusters - box of 6**  
**PGC16944** (342048)



**C** **Swiffer**



**D** **Swiffer**

**D Swiffer® Duster**

Traps and locks dust and allergens. Starter Kit contains 1 handle and 5 unscented duster refills.

**Starter kit**  
**PGC40509** (385773)  
**Refills dusters - box of 10**  
**PGC41767** (385716)

**E Lint Roller**

Removes pet hair, lint and fuzz. 60 perforated sheets.  
**MMM 836RS60CN** (779702) roller  
**MMM 836RFS60CN** (779710) refill

**F Spray Bottle**

Plastic. 24 ml capacity,  
**FOD 20671** (761452)

**G Brute® Pail**

Molded graduated scale for accurate measuring. Heavy-duty thick wall construction. 13.2 litres. Grey.  
**RUB 296300GY** (556001) 9.5 L  
**RUB 294520** (294520) 13.2 L



**E** **Scotch-Brite**



**F**



**H Bucket and Mop Strainer**

Durable plastic. Strainer wrings up to 10 oz mop. 14.2 litres. 17 x 10-1/2 x 12 in. Grey.  
**RUB 761718** (761718)

**I WaveBrake® Bucket/Wringer Combo**

Reduces splashing, which means a safer environment, cleaner floors, and improved productivity. 33 litres. Yellow.  
**RUB 758088YEL** (760710) side press  
**RUB 294595** (294595) vertical press

Find Floor Signs on **page 323**



**G** **Rubbermaid**  
Commercial Products



**H** **Rubbermaid**  
Commercial Products



**I** **Rubbermaid**  
Commercial Products



## A Tape Measure

Polymer-coated blade withstands abrasion. High-impact ABS case. 5 m/16 ft. Yellow.

**BOS 30-496** (375675)



**A** **STANLEY**

## B FatMax® Ratchet Screwdriver

3 position ratcheting mechanism: clockwise, counterclockwise and locked positions. Quick release magnetic bit holder. Includes 6 bits.

**BOS 69-189** (425611)



**B** **STANLEY**

## C 3 Pliers Set

Meets ANSI specifications Includes: 6 in slip joint pliers, 6 in diagonal pliers, 6 in long nose pliers. 3-piece set. Black.

**BOS 84-114** (527499)



**C** **STANLEY**

## D Screwdriver

Set includes the handle, chrome-plated bar which resist corrosion, standard and Phillips heads and two nut drivers.

**BOS 68-012** (1015256)



**D** **STANLEY**

## E Multi Purpose Scraper

Strong and durable handy scrapers. Scrapers are disposable.

Non-replaceable stainless steel blade.

**OLF 1086530** (1030683) 1 in.

**OLF 1086562** (1030691) 2-1/3 in.



**E** **OLFA**

## F Series 2000 Tool Box

Built in padlock eye and two lid organizers. Rubber coated handle. 19 x 10 x 10 in. 1 set. Accessories not included.

**BOS 019151M** (551010)



**F** **STANLEY**

## G Step Stool

13 in high. 350 lb capacity. Plastic. Anti-skid rubber base. Retractable casters.

**RUB 252300BEIG** (226258) beige

**RUB 252300BLA** (226217) black



**G** **Rubbermaid**  
Commercial Products

## H Deluxe Carry Caddy

Securely holds up to eight 32 oz spray bottles and other common cleaning tools. Ergonomic handle design provides comfortable fit. 15 x 10-9/10 x 7-2/5 in. Black.

**RUB FG315488BL** (527028)



**H** **Rubbermaid**  
Commercial Products

## I Handheld Tote Caddy

Made of molded industrial-grade polymers for durability.

13.8 x 18.4 x 9 in. Blue.

**AKM 09185BLUE** (1067677)



**I** **AKRO-MILS**

## J Janitor Cart

With zippered vinyl bag. Sturdy plastic has a smooth, easy-to-clean surface. Non-marking 8 in wheels and 4 in casters. Central shelf. Black.

**RUB 617388BLA** (204222)



**J** **Rubbermaid**  
Commercial Products

Vinyl bag included

Find Flash Lights  
on **page 324**

Find Utility Knives  
on **page 554**



**A** 



**B** 

**A Perfect Sweep Turbo Cordless Sweeper**  
Rechargeable sweeper has a one hour running time on hard floors and 45 minutes on carpets. Cleans crumbs, dirt and pet hair. Motorized three-brush system. Auto height adjustment.  
**BIS 2880F** (190967)

**B Carpet Sweeper**  
Ideal for a quick clean-up on bare floors or carpet. Black.  
**RUB 294579** (294579)

**C Polyester Broom**  
One-handed cleaning under tables, chairs, and hard-to-reach areas is easy with this angle broom. With water-absorbent polyester bristles for all types of messes. 35 in high. Black.  
**RUB 637400BL** (761700)

**D Lobby Pro Broom**  
Ideal for one-handed cleaning under tables. Ideal for restaurants, malls and lobbies. Stiff synthetic bristles.  
**RUB 294512** (294512)

**E Upright Dust Pan**  
With swivel broomstick. Black.  
**RUB FG253100BL** (761312)  
• **Optional hanging bracket**  
**RUB FG253500BL** (431460)



**C** 



**D** 

**F Tampico Push Broom**  
Tampico blend medium sweep push broom. For any facility where both fine dust and larger particles need to be moved. 24 in.  
**AGI 56024** (668574)

**G Tampico/Palmyra Push Broom**  
All natural fibres. that will biodegrade when disposed. Suitable for high heat situations. Heavy-duty block. 24 in.  
**AGI 6224** (170191)

**H Wooden Threaded Handle**  
15/16 in. diameter handle fits all tools that accept a standard threaded handle. 60 in.  
**AGI 52509** (669432)



**E** 



**F** 



**G** 



**H** 



## A Angle Broom

Long lasting stain resistant polypropylene bristles. Permanent fusion set bristles. 10.5 in wide. Grey.  
**RUB 637500** (1014679)

## B Angle Broom

High performance bristles provide cleaning action. Yellow.  
**GJO 58562** (1059682) 9 in.  
**GJO 09570** (1059674) 12 in.

## C Rite-Angle Angled Broom

Excellent size for use in entrances and stairways. 48 in handle.  
**AGI 792** (761437) 9 in.  
**AGI 797** (761346) 12 in.

## D Corn Fiber Toy Broom

Each fiber trap and hold dust particles for fast cleanup. Made corn fiber 100% for durability. 24 in. wooden handle.  
**GJO 11501EA** (1059740)

## E Dust Pan

Heavy-duty plastic. 12 in width. Black.  
**RUB FG200500CH** (761262)

## F Command™ Large Wire Hook

Designed for quick, easy, and damage-free hanging. Leaves behind no holes, marks, or sticky residue. Holds up to 5 lbs. 1 hook with 2 strips.  
 Works on a variety of smooth, finished, indoor surfaces, including painted walls, wood, tile, and glass. White.  
**MMM 17069C** (1033174)

## G Command™ Broom Grip

Damage-free hanging. Holds up to 4 lb (1.8 kg). Removes cleanly.  
**MMM 17007-EF** (371765)

## H Cleaning Tool Wall Organizer Rack

Designed to hold 5 objects with handles of varying thicknesses and 6 additional hangable objects. Made of ABS plastic; mounting hardware included. 16.5 in wide. Grey.  
**GJO 12504** (1062769)





**A** 



**B**

**A CleanView® Bagless Vacuum Cleaner**

OnePass™ Technology with powerful suction and innovative brush design, to clean most surface debris on the initial pass. Multi-level filtration with a washable filter. Lightweight design. Large capacity dirt bin with Easy Empty™ bottom. The TurboBrush® Tool cleans stairs, upholstery, auto interiors, and more. 2-year limited warranty. 7.5 m (25 ft) power cord, 1.75 m (6 ft) hose, and extension wand. **BIS 2316C** (425637)

**B QuietClean® Commercial Upright Vacuum**

Designed for daytime cleaning with innovative sound dampening technology. Bagged cleaner combines a clean-air system with the ultimate in filtration, sealed HEPA. LEED Compliant and CRI Green Label certified. Allergen disposable dust bag. 40 ft. Power cord. Black. **ERK 611632** (611632)

**C Commercial Upright Vacuum**

Standard filtration, shake out bag system. Produces an effective wave action that vibrates deeply embedded dirt. Replaceable bristle strips for continuous, deep cleaning every time. 6 position carpet height. 50 ft power cord. Cleaning path width of 12 in. **ERK 614396** (614396)

**D SpotClean® Professional Portable Deep Cleaning System**

Large capacity, removable tank. Comes with 3 in 1 stair tool and 3 in. tough stain brush. The 5 ft hose and 22 ft power cord make it easy to clean hard-to-reach areas such as rugs, stairs and upholstery and more. 5-year limited warranty. Black and orange. **BIS 3624C** (1015636)



**C**



**D** 

**E PowerClean® Multi-Cyclonic With Motorized Power Foot Canister Vacuum**

Compact design is lightweight and easy to carry for effortless maneuverability and transportation. Easy-Empty dirt tank empties from the bottom. Multilevel filtration system helps reduce allergens in rooms to prevent allergic reactions by those sensitive to dust and pollen. 12 in cleaning canister. 2-year limited warranty. Black and lime green. **BIS 1654C** (1015644)

**F CleanView® Upright Vacuum**

Scatter-free technology picks up on hard floors. Includes the turbobrush, dusting brush, crevice tool and extension wand. The Easy-Empty dirt tank that empties straight into the trash with the push of a button. Washable filters and multilevel filtration system. 25 ft power cord, 6 ft hose and a 13.5 in cleaning path provide an extended cleaning reach. 2-year limited warranty. Black and red. **BIS 2488C** (1015677)



**E** 



**F** 

## A Swiffer® XL Dry+Wet Sweeping Kit

1.5 X wider than Swiffer® Sweeper regular. Kit includes sweeper, 8 dry cloths and 2 wet cloths.

PGC 92816 (829215)

• Dry refills - package of 16

PGC 512723 (512723)

• Wet refills - package of 12

PGC 74471 (829218)



A



B

## B Swiffer® Dry+Wet Sweeping Kit

Metal handle. Kit includes sweeper, 7 dry sweeping cloths, 3 wet mopping cloths.

PGC92815 (360727)

• Dry refills

PGC512715 (512715) box 32 (Gain)

PGC33407 (149492) box 32

PGC 81233 (829214) pkg 48

• Wet refills

PGC35155 (512517) pkg 24

PGC 00737 (829217) box 36



## C Swiffer® Heavy Duty Cloth Refills

Package of 20.

PGC 77197 (829213) dry cloths

PGC 76472 (829216) wet cloths



C

## D Swiffer® WetJet™ Mopping Kit

All-in-one mopping system. Starter kit includes 1 power mop with scrubbing strip, 2 cleaning pads, 1 bottle of 500 ml multi-purpose cleaning solution. Requires 4 AA batteries (included).

PGC92811 (364026)

• Multi-surface refills - box of 24

PGC08443 (157909)



D

## E Swiffer® WetJet™ Heavy Duty Refill Pads

The thick, multi-layered pads have a built-in scrubbing strip that helps remove tough messes, and absorbs and locks soils deep inside.

Package of 20.

PGC 81789 (829219)



E

## F Swiffer® WetJet™ Multi-Purpose Cleaning Solution

1.25 L.

Open window fresh fragrance

PGC23679 (584714) by each

PGC 26535 (829220) pkg 2

Sweet citrus and zest fragrance

PGC24334 (585380) by each



F



 <p><b>A</b> <b>atlas graham</b></p>	 <p><b>B</b> <b>GENUINE JOE</b></p>	 <p><b>C</b> <b>Rubbermaid Commercial Products</b></p>	<p><b>A Dust Mop</b> Includes handle and 24 in. frame. Dust mop head sold separately. <b>AGI 12524</b> (743609) handle and frame <b>AGI 24824</b> (743583) dust mop</p> <p><b>B Dust Mops, Frames and Handles</b> The 360 swivel frame rotates from all angles. Black powder coating to resist rust. <b>Complete mop</b> <b>GJO 54101</b> (1060326) 24 in. • <b>Frame</b> <b>GJO 48264EA</b> (1059550) 24 in. <b>GJO 48266</b> (1060615) 48 in.</p> <p><b>C Executive Pulse™ Mopping Kit</b> Aluminum. Includes handle and frame. Handles in adjustable lengths between 20 and 72 in. Extension poles with lengths up to 18 in. Quick-Connect™ system. 5.6 x 4.88 x 3.75 in. Silver. <b>RUB 1863884</b> (266957) • <b>Replacement pad</b> <b>RUB 1863895</b> (267005)</p>
 <p><b>D</b> <b>Rubbermaid Commercial Products</b></p>	 <p><b>E</b> <b>Rubbermaid Commercial Products</b></p>	 <p><b>F</b> <b>Rubbermaid Commercial Products</b></p>	<p><b>D Pro-Spray Spray Mop</b> Lighter duty spray mop streamlines the mopping process for improved productivity. <b>RUB 3486108</b> (294561) • <b>Replacement pad</b> <b>RUB Q41000BL00</b> (294694) blue (wet) <b>RUB Q41800GR00</b> (294702) green (dry) • <b>Replacement pad holder</b> <b>RUB Q56000YL00</b> (564740) • <b>Replacement handle - 54 in.</b> <b>RUB Q75000YL00</b> (564757)</p> <p><b>E Reveal™ Spray Mop</b> Safe to use on all floor types including hardwood, vinyl, laminate and tile. Microfiber pads are reusable and machine washable up to 100 times. Constructed with durable, yet lightweight material. 16.5 x 5.5 in. <b>RUB 1782331</b> (371427)</p> <p><b>F Steel Sponge-Mop</b> 43-1/4 in handle. Handle-mounted squeeze-action lever. Includes a 12 in wide replaceable synthetic cellulose head. <b>RUB 643500</b> (223339)</p>
 <p><b>G</b> <b>atlas graham</b> </p>	 <p><b>H</b> <b>atlas graham</b></p>	 <p><b>I</b> <b>Rubbermaid Commercial Products</b></p>	<p><b>G Quickway Mop Painted Metal Handle</b> 54 in. epoxy-coated metal wet mop handle. For use with narrow-band mops. <b>AGI 4754</b> (668566)</p> <p><b>H EZ-Change Mop Handle</b> Fiberglass handle. 54 in. Blue. <b>AGI 16574</b> (170217)</p> <p><b>I Mop Handle</b> Fiberglass handle. Thumb release mechanism. 60 in. Yellow. <b>RUB FGH1450000</b> (319988)</p> <p><b>J Wood Wet Mop Handle</b> Large steel head. 60 in. <b>RUB FGH5160000</b> (542738)</p>

**A Yacht Round Mop**

Cotton. With 54 in handle. 10 oz. White.  
AGI 2210 (761213)



**B Cotton Wet Mop**

24 oz. cotton 4-ply narrow head band, cut end yarn with 60 in. handle.  
GJO 54201 (1061076)



**C Microfibre Wet Mop**

Wet mop in microfibre tube with 60 in. handle. Very absorbent.  
The canvas headband is durable in the wash. Blue.

**Mop and handle**  
GJO 47537 (1061225) medium

**Mop refill**  
GJO 47538 (1061259) small  
GJO 47539 (1061241) medium

**D Tuffstuff™ Mop**

For general washing, scrubbing, disinfecting and stripping. Blue.

AGI 1732 (170209) medium  
AGI 1733 (170159) large



**E Dura Pro Mop Head**

Cut end, 4-ply cotton/rayon/synthetic yarn.  
Good performance and durability. White.

RUB 294652 (294652) 20 oz  
RUB 294660 (294660) 24 oz



**F Value Pro Mop Head**

Cotton. All-purpose mop for general cleaning duties. White.

RUB 294736 (294736) 16 oz  
RUB FGV11700WH (319806) 20 oz  
RUBFGV11800WH (294744) 24 oz

**G Floor Mop**

Mop head. White.  
AGI 1616 (221432) 16 oz  
AGI 1624 (668558) 24 oz



**H Economy Wet Mop**

Cotton 4-ply narrow band. Cut ends. 20 oz.  
GJO N20COTEA (1061191)



**I Hy-Sorb Disposable Mop Head Refill**

Lightweight mop head is non-linting, mildew-resistant and fast-drying,  
and fits any professional stirrup-style style or jaw-style handle. Blue.

GJO 48255 (1061092)



**J Natural and Polyester Blend Mop Head**

Designed to be used with a saddle or jaw handle due  
to its narrow 1" headband. White.

GJO 48259 (1061605) 16 oz  
GJO 48260 (1061613) 24 oz



Find Buckets and Wringers  
on page 366





## 50% EASIER TO LIFT LINERS

The vented BRUTE® container makes backbreaking work easy with innovations you (and your back) will appreciate.



BUILT-IN VENTING CHANNELS

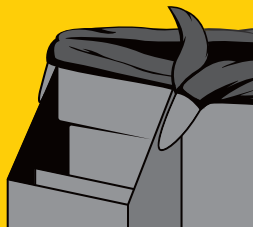

CINCHES KEEP BAG FROM FALLING IN



# BRUTE®



## A Fire-Safe Trash Can

Features a raised bottom to prevent heat transfer to the floor in case of a fire. Solid ribbed construction and rolled wire top rim. Trash can will not melt or emit toxic fumes in case of fire. Greenguard Certified. Limited lifetime warranty. 13 x 14 in. Black.

**GJO 58897** (1059781)



**A**



Fire resistant

**B**



Fire resistant



## B Fire Resistant Wastebasket

Contain burning paper without the wastebasket melting or contributing fuel to the container's contents. 13.2 liters. 8 x 11 x 12 in. Black.

**RUB FG254100BL** (1073006)

## C Mesh Waste Basket

Durable mesh wire with smooth finish. 11-5/8 x 13-3/4 in. Black.

**WNN 12351** (549915)

## D Round Waste Bin

Wire mesh. 4.7 gallons. 12 x 14 in. Black.

**LLR 52770** (1015792)

## E Plastic Rectangular Wastebasket

Black. 100% recycled content.

**STX 00710U06C** (425215) 14-1/4 x 10-1/4 x 15 in. H

**STX 00700U04C** (425223) 15-1/4 x 11 x 20 in. H

## F Rectangular Wastebasket

Polyethylene. 28 L. 14 1/2 x 10 1/2 x 15 in. Black.

**SPR 02160** (1015768)

## G Deskside Wastebasket

All-plastic construction; won't chip, rust or dent. Rolled rim adds strength, and is easy to clean.

**Small - 12.9 L - 11-3/8 x 8-1/4 x 12-1/8 in. H**

**RUB 295500BLA** (226308) black

**RUB 252098** (252098) grey

**RUB 295500BEIG** (226316) beige

**Medium - 26.6 L - 14-1/4 x 10-1/4 x 15 in. H**

**RUB295600BLA** (252106) black

**RUB295600GRAY** (252130) grey

**RUB295600BEIG** (252122) beige

**Large - 39 L - 15-1/4 x 11 x 20 in. H**

**RUB295700BLA** (268086) black

**RUB295700GRAY** (268094) grey

**RUB295700BEIG** (267997) beige



**C**

Winnable

**D**

LORELL



**E**

STOREX



**F**

Sparco



**G**





**A Recycling Side Bin**

Allows segregation of trash and recycling. Attaches to Deskside Wastebaskets. All-plastic construction; won't chip, rust or dent. Rolled rim adds strength, and is easy to clean. 10-5/8 x 7-1/4 x 11-1/2 in. Blue. **RUB 295073BLUE** (267070)

**B Recycling Waste Basket**

12.9 litres. Blue. 35% post-consumer recycled content. **RUB 295573BLUE** (336461)

**C Deskside Recycling Wastebasket**

All-plastic construction; won't chip, rust or dent. Rolled rim adds strength, and is easy to clean. 26.6 liters. 14-1/4 x 10-1/4 x 15 in. Blue. **RUB 295673BLUE** (460691)

**D Recycling Plastic Wastepaper Basket**

Plastic. 14-1/4 x 10-1/4 x 15 in. Blue. 10% recycled content. **STX 00714U06C** (425231)



**E Personal Recycling Wastebasket**

Ideal for recycling office papers. Fits under standard desks. 16-3/4 x 11-7/8 x 8-1/4 in. Blue. **STX 61517U06C** (527606)

**F Personal Recycling Bin**

Built from heavy-duty polypropylene. 13-1/2 x 11 x 7-3/4 in. Blue. **STX 61505U06C** (537712)

**G Recycling Bin**

17-7/8 x 13-7/8 x 10-1/2 in. Blue. **STX 61549U06C** (571430)

**H Commercial Recycling Box**

Commercial grade construction to withstand years of indoor and outdoor use. Built-in handle for easy lifting and carrying. 20-3/4 x 16 x 14-3/4 in. Blue. **RUB 110734** (110734)



## A Step On Receptacle

Lid closes automatically after every use. Plastic. 4 gallons.  
12 x 10 x 15 in. Black.  
SAF 9710BL (1061589)

## B Step-On Wastebasket

Plastic. Step-on feature. 64-L capacity. 19-3/4 x 16-1/4 x 26-1/4 in. Black.  
SAF 9922BL (320630)

## C Untouchable® Wastebasket

23-gallon capacity. 16-1/2 x 15-1/2 x 30-7/8 in.  
Basket and lid sold separately.

### Basket

RUB 783589 (783589) grey  
RUB783951 (783951) beige

### Lid

RUB 785709 (785709) black  
RUB785691 (785691) beige



## D Slim Jim® Container

Integrated innovative venting channels take the strain out of liner removal. Four can liner cinches. Molded-in handles. 23 gallons (87.1 litres). 22 x 11 x 30 in. Basket and lid sold separately.

### Basket

RUB 354060GRAY (294868) grey

### Swing lid

RUB 294819 (294819) black

RUB267360GRAY (1074665) grey

### Hinged lid

RUB 267400BLA (294801) black



## E Bac Slim Jim® Confidential Container

With lid. Comprehensive secure document solution to help meet HIPAA needs. Designed for tight spaces. Narrow easy-to-use paper slot prevents unauthorized entry. 11 x 20 x 31 in. Grey.  
RUB 294843 (294843)

## F Untouchables Swing Lid Top

11-5/8 x 7 x 16 in. Black.

RUB 306600BLA (1074681) for 2956 series

RUB306700BLA (1074699) for 2957 series

## G Slim Jim® Recycling Wastebasket

Integrated innovative venting channels take the strain out of liner removal. Four can liner cinches. Molded-in handles. 23 gallons. 22 x 11 x 30 in. Blue. Basket and lid sold separately.

### Basket

RUB FG354007BL (187781)

### Lid for paper

RUB270388BE (294827)

### Lid for paper and bottles

RUB 1788372 (187740)





**A**



**B**



**A Brute® Round Waste Container**

Very strong plastic. Built-in handles. 32 gallons. 22 in diameter. Grey. Container and lid sold separately.

**Container**  
**RUB 263200GRAY** (304121)

**Lid**  
**RUB 263100GRAY** (304253) grey

**B Brute® Recycling Container**

Perfect as central collection container. Contains post-consumer recycled resin. 32 gallons. 22 x 27-1/4 in. Blue. Container and lid sold separately.

**Container**  
**RUB 263273BLUE** (187773)

**Lid for bottles/cans recycling**  
**RUB 1788376** (187757)

**C Brute® Waste Container**

Very strong plastic. Built-in handles. 44 gallons (166.5 litres). 24 x 31-1/2 in. Blue.

**RUB 761304** (761304)

**D Brute Container Dolly**

Heavy-duty polyurethane. 5 swivel casters. 18-1/4 in. diameter. 6-5/8 in. H.

**RUB 264000BLA** (761189)

**E Brute® Rollout Container With Lid**

With lid. Perfect as central collection container. Heavy-duty wheels roll easily even over steps or curbing. 50 gallons. 28-1/2 x 23 x 36-1/2 in. Grey with black lid.

**RUB 9W2700GRAY** (1015867)

**F Brute® Recycling Rollout Container**

With lid. Perfect as central collection container. Heavy-duty wheels roll easily even over steps or curbing. 50 gallons. 28-1/2 x 23 x 36-1/2 in. Blue with black lid.

**RUB 9W2773BLUE** (187799)

**G Smokers' Station Wall Mount**

Keyed cam lock. Powder coated black textured galvanized steel body with brushed stainless steel door. Two stainless steel extinguishing screens. Mounting hardware. 10 x 3 x 12-1/2 in.

**RUB R1012EBK** (260745)

**H GroundsKeeper® Smoking Management Receptacle**

Tuscan architectural style. Stainless steel snuff plate minimizes smoldering. Inner galvanized steel canister holds large quantities of cigarette waste. Sandstone finish. Anchor holes. 13 x 13 x 38-3/8 in. Black.

**RUB 9W3000BLA** (123109)

• **Anchor kit**  
**RUB 247031** (247031)



**C**



**D**



**E**



**F**



**G**



**H**

## A Small 100% Compostable Garbage Bags

Compost bags meet the requirements of municipal compost programs, ASTM D6400 standards and are certified compostable by the industry standards authority, BPI and BNQ. Febreze lemon scent helps suppress the worst trash odours.

- 16 x 17 in.
- CLO 78162** (458174) box 20
- CLO 30161FRM7** (1015123) box 44
- CLO 30265FRM7** (1015115) box 100
- 24 x 31 in.
- CLO 78163FRM5** (458182) box 10

## B Biosak® 100% Compostable Garbage Bags

Compost bags meet the requirements of municipal compost programs, ASTM D6400-40 and BNQ 0017-088 standards. Certified compostable by the industry standards authority, BPI and BNQ. 16-1/4 x 17-1/2 in. Package of 20.

- RLS 0503-03** (511022)

## C Compostable Garbage Bags

Made from 100% Non-GMO plant-based materials. Biodegradable and environment-friendly.

- LEF 831166** (831166) 35 x 39 in. (pkg 100)
- LEF 831167** (831167) 35 x 52 in. (pkg 200)
- LEF 831165** (831165) 16 x 16 in. (pkg 30)

## D Biosak® 2100 Series Biodegradable and Compostable Garbage Bags

Certified compostable by BPI (ASTM D6400) and BNQ 0017-088.

All bags are printed with the compostable certification logo.

- RLS 2171-03** (511006) 26 x 36 in. (box 150)

- RLS 2185-03** (511014) 35 x 50 in. (box 75)

## E Supersak® Kitchen Garbage Bags

Rollform, wrapped in a paper label. No-knife, tear-away carton.

Tie flap closure. 48 bags per roll. 20 x 23-1/4 in. Box of 12 rolls. White.

- RLS 401-10** (510990)

## F Maximum Kitchen Garbage Bag

Made of virgin hexene and reprocessed plastics resin blends.

Fast tie flaps. Odour protection. 22 x 24 in. Box of 40. White.

- FOD 42224** (206185)

## G Small Garbage Bags With Febreze

Strong and sturdy with tie flap closure. Febreze fresh and clean scent helps suppress the worst trash odours. 20 x 20 in. White.

- CLO 30219FRM1** (1014802) box 48

















- CLO 30220FRM1** (1015157) box 100

## H Tall Garbage Bags With Febreze

Strong and sturdy with tie flap closure. Febreze fresh and clean scent helps suppress the worst trash odours. 24 x 28 in. Box of 30. White.

- CLO 30221FRM1** (1014810)

### COMPOSTABLE BAGS

 <p><b>A</b></p>  	 <p><b>B</b></p>   <p><b>INTEPLAST GROUP</b> W. Ralston</p>
 <p><b>C</b></p>  	 <p><b>D</b></p>   <p><b>INTEPLAST GROUP</b> W. Ralston</p>
 <p><b>E</b></p>   <p><b>INTEPLAST GROUP</b> W. Ralston</p>	 <p><b>F</b></p> 
 <p><b>G</b></p> 	 <p><b>H</b></p> 



All garage bags on this page made in Canada and are EcoLogo® certified.

**A**



**A 2500 Series Industrial Garbage Bags**

Extra strong. Black. EcoLogo.  
**RLS 258301** (829365) 30 x 38 in. (box 125)  
**RLS 258501** (829366) 35 x 50 in. (box 100)

**B 2600 Series Garbage Bags**

Certified not to leak, tear, or puncture easily. UL EcoLogo®  
 Certified - UL-126. One-at-a-time dispensing. Black. Contains recycled and post-consumer content.  
**20 x 22 in.**  
**RLS 2652-01** (510891) regular (500)  
**22 x 24 in.**  
**RLS 2654-01** (294348) regular (500)  
**26 x 36 in.**  
**RLS 2661-01** (510909) regular (250)  
**RLS 2671-01** (526558) strong (200)  
**RLS 2681-01** (510958) extra-strong (125)  
**30 x 38 in.**  
**RLS 2663-01** (510917) regular (250)  
**RLS 2673-01** (293381) strong (box 200)  
**RLS 2683-01** (1014852) extra-strong (125)  
**35 x 50 in.**  
**RLS 2665-01** (510925) regular (200)  
**RLS 2675-01** (510933) strong (125)  
**RLS 2685-01** (294140) extra-strong (100)  
**42 x 48 in.**  
**RLS 2677-01** (510941) strong (125)  
**RLS 2687-01** (529149) extra-strong (75)

**B**



**C 2700 Series Industrial Garbage Bags**

Extra strong. 30 x 38 in. Box of 125. Black. EcoLogo.  
**RLS278301** (829367)

**D 2800 Series Industrial Garbage Bags**

Made from high density resin. Ideal for heavy, wet trash.  
**20 x 22 in.**  
**RLS 2832-90** (510966) utility frosted (1000)  
**22 x 24 in.**  
**RLS 2824-90** (293282) utility frosted (1000)  
**RLS 2824-91** (293274) utility black (1000)  
**26 x 36 in.**  
**RLS 286190** (829362) regular frosted (500)  
**RLS 2861-91** (293506) regular black (500)  
**RLS 2871-90** (293514) strong frosted (500)  
**30 x 38 in.**  
**RLS 286390** (829363) regular frosted (500)  
**36 x 50 in.**  
**RLS 2865-90** (510974) regular frosted (250)  
**RLS 287590** (829364) strong frosted (250)  
**RLS 2885-90** (293415) extra-strong frosted (200)  
**RLS 2885-91** (293407) extra-strong black (200)  
**43 x 48 in.**  
**RLS 287790** (829361) strong frosted (250)

**C**



**E 2900 Series Industrial Garbage Bags**

Meets requirements of Fisheries Act and the Canadian Environmental Protection Act (CEPA) for manufacture and transport. Dispenser box. EcoLogo™ certified. Contains recycled content.  
**20 x 22 in.**  
**RLS 2952-00** (510800) regular clear (500)  
**RLS 2952-10** (510818) regular white (500)  
**26 x 36 in.**  
**RLS 2961-00** (510826) regular clear (250)  
**RLS 2971-00** (294223) strong clear (200)  
**RLS 2971-08** (510859) strong blue (200)  
**RLS 2981-00** (1014869) extra-strong clear (125)  
**30 x 38 in.**  
**RLS 2963-00** (510834) regular clear (250)  
**RLS 2973-00** (293399) strong clear (200)  
**RLS 297307** (591115) strong green (200)  
**35 x 50 in.**  
**RLS 2985-00** (294157) regular clear (100)  
**RLS 2965-00** (510842) regular clear (200)  
**RLS 2975-00** (510867) strong clear (125)  
**RLS 2975-08** (510875) strong blue (125)  
**42 x 48 in.**  
**RLS 2987-00** (510883) extra-strong clear (75)

**D**



**E**



## A SUPERSAK® Garbage Bags

Perforated tear off roll. Dispenser box. EcoLogo™ certified. Black.  
**For contractors - 33 x 45 in. - box of 32**  
**RLS 378-01** (510784)  
**3 MIL - 33 x 48 in - box of 30**  
**RLS 379-01** (510792)



## B Supersak® Garbage Bags

Rollform, wrapped in a paper label. No-knife, tear-away carton.  
 Tie flap closure. EcoLogo™ certified. 20 bags per roll. 26 x 34-3/4 in.  
 Box of 12 rolls. Black.  
**RLS 404-01** (510982)

## C Genuine 2-Ply Garbage Bags

Multipurpose, low density polyethylene. Star bottom. In rolls. Black.  
**GJO 02147** (1014927) 23 x 24 in. (box 500)  
**GJO 02148** (1014877) 24 x 33 in. (box 500)  
**GJO 02149** (1014885) 30 x 36 in. (box 250)  
**GJO 02150** (1014893) 33 x 39 in. (box 250)  
**GJO 02152** (1014919) 38 x 58 in. (box 100)  
**GJO 02151** (1014901) 40 x 46 in. (box 250)

## D Large Bags 90 L

Specifically for customers living in municipalities that allow plastic bags.  
 Strong and sturdy with tie flap closure. 30 x 33 in. Box of 30.  
**CLO 11578PAK2** (1015107) blue  
**CLO 11837PAK2** (1015065) black

## E Tall Bags 45 L

The unique ForceFlex® Diamond Texture stretches with your trash  
 to prevent rips and tears. Drawstring closure. 24 x 28 in.  
**CLO 30301** (804518) blue (box 50)  
**CLO 30306** (1015131) black (box 24)  
**CLO 30308** (1015073) black (box 60)

## F Extra Large Bags

Strong and sturdy with tie flap closure. 31 x 42 in. Box of 20.  
**CLO 30312** (579607) black  
**CLO 30314** (579599) clear

## G Giant Garbage Bags

Strong and sturdy with tie flap closure. 35 x 48 in. Box of 40. Black.  
**CLO 80049-4** (1014786)

## H Maximum Garbage Bags

Made of virgin hexene and reprocessed plastics resin blends.  
 Fast tie flaps. Odour protection. 26 x 32-1/2 in. Box of 40. Black.  
**FOD 28040** (206201)





**A**

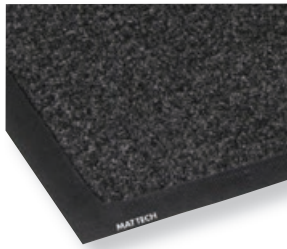

**B**



**C**

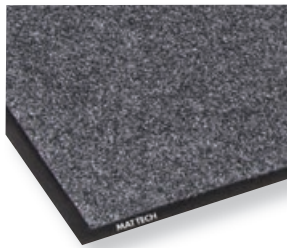

**D**



**E**

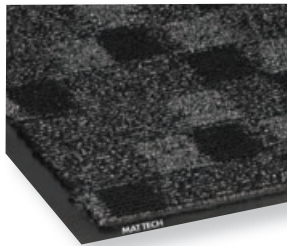

**F**

**A Safewalk™ Light Entrance Mat**

Made from SBR rubber. Provides a safe environment for wet locations. Surface with raised holes provides excellent traction with optimal drainage. Bevelled edges. 1/2 in. thick. 36 x 60 in. 1-year limited warranty.  
**MAE WSSL35BK** (833078) black  
**MAE WSSL35TC** (833079) terra cotta

**B Super Soaker™ Entrance Mat**

Classic rubber mat offering an improved durability. Ideal for medium-traffic areas. Crush-resistant molded mat with waffled pattern. Recycled rubber backing grips mat to your floor. 3/8 in. thick. 2.11 x 4.10 ft. 1-year limited warranty. Charcoal.  
**MAE 24M3554** (833080)

**C Mat-A-Dor™ Entrance Mat**

Scraper mat with rubber fingers. Remains flexible and efficient even in coldest temperatures. Bevelled edges to contain water and dirt. Ideal for indoor/outdoor entrances in medium traffic areas. 5/8 in. thick. 1-year limited warranty. Black.  
**MAE MASK29BK** (833081) 32 x 39 in.  
**MAE MAF62BK** (833082) 36 x 72 in.

**D Eco Step™ Entrance Mat**

Ecological and economical. Ideal for indoor light traffic areas. Textured surface and Thermoflex® vinyl backing. 100% recycled fibres. 1/4 in. thick. 1-year limited warranty. Charcoal.  
**MAE ETM354SM** (833085) 24 x 36 in.  
**MAE ETM3554** (833086) 36 x 60 in.  
**MAE ETM4654** (833087) 48 x 72 in.

**E Prorib Entrance Mat**

Economical ribbed mat offering efficient performance. Vinyl backing. Ideal for light-traffic areas. 5/16 in. thick. 1-year limited warranty. Charcoal.  
**MAE 3LM354SM** (833088) 36 x 48 in.  
**MAE 3LM3554** (833083) 36 x 60 in.  
**MAE 3LM4654** (833084) 48 x 72 in.

**F Terra Nova Entrance Mat**

Dense polypropylene fibre and loop-pile surface for effective water retention and crush resistance to maintain appearance. Thermoflex+ backing provides 99.9% antimicrobial protection. Ideal for medium traffic areas. 5/16 in. thick. 1-year limited warranty. Charcoal.  
**MAE TVM31054** (833090) 36 x 120 in.  
**MAE TVM3554** (833089) 36 x 60 in.

**G Locker Boot Tray**

Keeps your locker clean by trapping mud, snow, and ice. Fits most standard lockers. 100 % PVC. 13 x 11 in. Black.  
**MGE 547976** (547976)



**G** MERANGUE





## A Astro-Plus™ Entrance Mat

Heavy-duty polyethylene material. Scraper-type mat, textured surface effectively traps and holds dirt, sand and salt. Ideal for indoor or outdoor high-traffic areas. 5/8 in. thick. 39 x 48 in. Total Confidence Warranty. Charcoal.

**MAE 833091** (833091)

## B Cambridge Prestige Entrance Mat

Made from polypropylene with Thermoflex® Plus vinyl backing for antimicrobial protection. Ideal medium to heavy traffic areas. Diamond pattern on black background. 3/8 in. thick. Total Confidence Warranty. Cobalt.

**MAE CAM3554** (833092) 36 x 60 in.

**MAE CAM31054** (833093) 36 x 120 in.

## C Tuff Spun® Anti-Fatigue Mat

PVC foam promoting fatigue relief. Beveled edges for increased safety. 1-yr limited warranty. 3/8 in. thick.

**24 x 36 in.**

**MAE FP2436BK** (833062) black

**MAEFP2436GY** (833064) grey

**36 x 60 in.**

**MAE FPS660BK** (833063) black

**MAEFPS660GY** (833065) grey

## D Industrial Deck Plate Anti-Fatigue Mat

Diamond patterned vinyl surface fused to an industrial grade PVC foam backing to offer comfort and relief. Resists most fluids and chemicals. Durable slip-resistant surface for increased security. 1-year limited warranty. 9/16 in. thick.

**24 x 36 in.**

**MAE CUMR46DB** (833066) black

**MAE CUMR46YB** (833068) black/yellow border

**36 x 60 in.**

**MAE CUMR60DB** (833067) black

**MAE CUMR60YB** (833069) black /yellow border

## E Cushion Step Anti-Fatigue Mat

Smooth vinyl surface with marbled design bonded with PVC foam. Durable and easy to clean. 1-year limited warranty. 1/2 in. thick.

**24 x 36 in.**

**MAE CUMR46SB** (833070) black

**MAE CUMR46SF** (833072) grey

**36 x 60 in.**

**MAE CUMR60SB** (833071) black

**MAE CUMR60SF** (833073) grey

## F Comfort King™ Anti-Fatigue Mat

Made of energizing Zedlan™ foam with a nitrile surface material. Combines flexibility and resilience for exceptional relief. The rebound property (resilience) stimulated blood circulation and reduces muscles fatigue. Bevelled borders. Total confidence warranty. 24 x 36 in. Black.

**Standard - 3/8 in. thick**

**MAE 833074** (833074)

**Supreme - 1/2 in. thick**

**MAE CKSM0023BK** (833075)

## G Elegance Anti-Fatigue Mat

Made of energizing Zedlan foam. Combines flexibility, resilience, and durability for exceptional relief. NSF1 certified Zedlan foam provides added traction to the ground. Bevelled borders. Total confidence warranty. 9/16 in. thick. Grey.

**MAE WE1223TY** (833076) 24 x 36 in.

**MAE WE1235TY** (833077) 36 x 60 in.



A

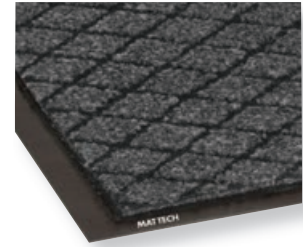

B

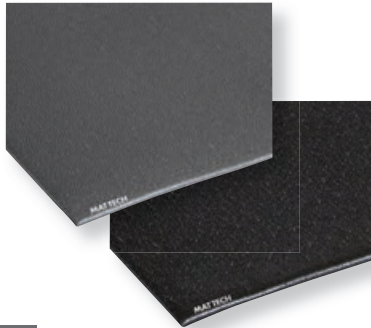

C



D

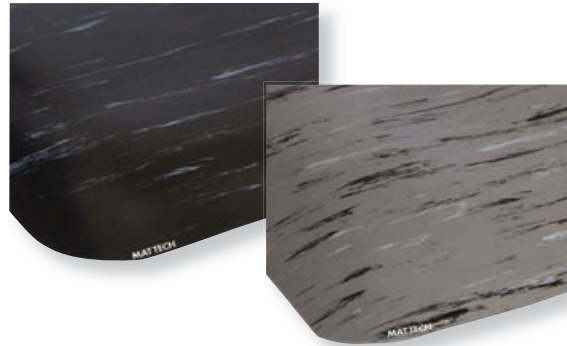

E

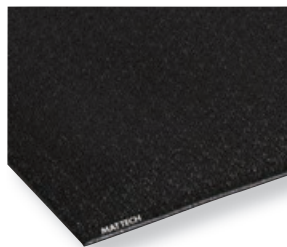

F



G

Find antifatigue mats for sit-to-stand desks on **page 161**



**SupremeX**



**A**



**B**

**A Standard White Envelopes**

#10, 4-1/8 x 9-1/2 in. Open side. 24 lb. Box of 500. FSC® certified.  
**SPX 357061** (357061) without window  
**SPX 1024445FNL** (357103) with window

**B Cross Back Envelopes**

#10, 4-1/8 x 9-1/2 in. Open side, V-flap. 24 lb. Box of 500. FSC® certified.  
**SPX 357095** (357095) without window  
**SPX 357111** (357111) with window

**C Security Envelopes**

#10, 4-1/8 x 9-1/2 in. Tinted interior. Open side. 24 lb. Box of 500. FSC® certified.  
**SPX 357137** (357137) without window  
**SPX 1024480FNL** (357152) with window

**D Natural Kraft Recycled Envelopes**

#10, 4-1/8 x 9-1/2 in. Open side. 24 lb. Box of 500. FSC® certified.  
**SPX 1000420FSC** (357178) without window  
**SPX 1024420FSC** (357186) with window

**E Ink Jet and Laser Envelopes**

#10, 4-1/8 x 9-1/2 in. Designed for use with printer. Without window. Open side. 24 lb. Box of 500. FSC® certified.  
**SPX 357194** (357194)

**F Flip-N-Fold Envelopes**

#10, 4-1/8 x 9-1/2 in. Tinted interior. With window. Open side. Self-sealing. 24 lb. Box of 500. FSC® certified.  
**SPX 357210** (357210)

**G Peel and Seal Envelopes**

#10, 4-1/8 x 9-1/2 in. Open side. Self-sealing. 24 lb. Box of 500. FSC® certified.  
**SPX 357228** (357228) standard  
**SPX 357236** (357236) security

**H Insertion Friendly Envelopes**

#10, 4-1/8 x 9-1/2 in. Open side. 24 lb. Box of 500. FSC® certified.  
**Standard**  
**SPX 1045440FSC** (357244) without window  
**SPX 1040440FSC** (549030) with window  
**Security**  
**SPX 1040480FSC** (1050376) with window

**I Digital Window Film Envelopes**

#10, 4-1/8 x 9-1/2 in. With window. Window film that won't melt in digital printers. Open side. 4 lb. Box of 500. FSC® certified.  
**SPX 1024445FSX** (1050368)

**J Open-End Envelopes**

#10, 4-1/8 x 9-1/2 in. With window. Open end. Gummed flap. 24 lb. Box of 500. FSC® certified.  
**SPX 5000440** (1050384)



**C**



**D**



**E**



**F**



**G**



**H**



**I**



**J**

All products on this page are FSC® certified



# #10 Business Envelopes | Mailroom and Handling

## A Reveal N Seal® Security Envelopes

#10, 4-1/8 x 9-1/2 in. Open side. Self-sealing. Box of 500.  
**QUA 67219** (165191) with window  
**QUA 67419** (564302) with window



**A** **TOPS**  
PRODUCTS



**B** **TOPS**  
PRODUCTS



## B Redi-Strip™ Security Envelopes

#10, 4-1/8 x 9-1/2 in. Open side. Self-sealing. Box of 30.  
**QUA 69112** (1052852)



## C Redi-Seal Security Envelopes

#10, 4-1/8 x 9-1/2 in. Double window. Tinted interior. Open side. Self-sealing. 24 lb. Box of 500.  
**QUA 24559** (1052935)



**C** **TOPS**  
PRODUCTS



**D** **TOPS**  
PRODUCTS



## E Peel-To-Seal Security Envelopes

#10, 4-1/8 x 9-1/2 in. Tinted interior. Open side. Self-sealing. Box of 500.  
**BSN 36682** (1050525) without window  
**BSN 16473** (1050533) with window



## F Redi-Seal Security Envelopes

#10, 4-1/8 x 9-1/2 in. Tinted interior. Open side. Self-sealing. 24 lb. Box of 500.  
**BSN 42207** (1050889)

## G Standard White Envelopes

#10, 4-1/8 x 9-1/2 in. Without window. Open side. 24 lb. Box of 500.  
**BSN 42250** (1050434) without window  
**BSN 42251** (1050450) with window



**E** **B** BUSINESS SOURCE®



**F** **B** BUSINESS SOURCE®



## H Double Window Security Envelopes

#10, 4-1/8 x 9-1/2 in. Double window. Tinted interior. Open side. 24 lb. Box of 500.  
**BSN 36694** (1050731)

## I Cross Back Envelopes

#10, 4-1/8 x 9-1/2 in. With window. Open side, V-flap. 24 lb. Box of 500.  
**BSN 42205** (1050749)



**G** **B** BUSINESS SOURCE®



## J Peel-To-Seal Envelopes

#10, 4-1/8 x 9-1/2 in. Open side. Self-sealing. 24 lb. Box of 500.  
**BSN 04646** (1050871)



**H** **B** BUSINESS SOURCE®



**I** **B** BUSINESS SOURCE®



**J** **B** BUSINESS SOURCE®





**A** *Hilroy*



**B** *Hilroy*

**A Press-It Seal-It® Envelopes**

#10, 4-1/8 x 9-1/2 in. Without window. Open side. Self-sealing. Box of 50.  
HLR 36712 (240507)

**B Press-It Seal-It® Security Envelopes**

#10, 4-1/8 x 9-1/2 in. Tinted interior. Without window. Open side. Self-sealing. Box of 45.  
HLR 36713 (240515)

**C Standard White Envelopes**

#10, 4-1/8 x 9-1/2 in. Without window. Open side. Box of 50.  
HLR 36612 (268060)



**C** *Hilroy*



**D** *Hilroy*

**D White Security Envelopes**

#10, 4-1/8 x 9-1/2 in. Tinted interior. Without window. Open side. Box of 40.  
HLR 36613 (268078)

**E Standard White Envelopes**

#9, 3-7/8 x 8-7/8 in. Open side. 24 lb. Box of 500. FSC® certified.  
SPX 0900445FNL (357079) without window  
SPX 0924445FNL (357129) with window

**F Security Envelopes**

#9, 3-7/8 x 8-7/8 in. Tinted interior. Open side. 24 lb. Box of 500. FSC® certified.  
SPX 357145 (357145) without window  
SPX0924480FSC (357160) with window  
QUAC0164 (369199) double window



**E** *SupremeX*



**F** *SupremeX*



**G Reveal N Seal® Security Envelope**

#9, 3-7/8 x 8-7/8 in. Double window. Tinted interior. Open side. Self-sealing. Box of 500.  
QUA 67529 (526509)

**H Double Window Security Envelopes**

#9, 3-7/8 x 8-7/8 in. Double window. Tinted interior. Open side. 24 lb. Box of 100. 30% recycled content.  
BLI HE4000 (562538)

**I Redi-Seal Security Envelopes**

#9, 3-7/8 x 8-7/8 in. Double window. Tinted interior. Open side. Self-sealing. 24 lb. Box of 500.  
BSN 36681 (1050541)

**J Double Window Security Envelopes**

#9, 3-7/8 x 8-7/8 in. Double window. Tinted interior. Open side. 24 lb. Box of 500.  
BSN 36680 (1050632)

**K Cross Back Envelopes**

#9, 3-7/8 x 8-7/8 in. Double window. Tinted interior. Open side, V-flap. 24 lb. Box of 500.  
BSN 42206 (1050723)



**G** *TOPS PRODUCTS*



**H** *Blueline*



**I** *BUSINESS SOURCE*



**J** *BUSINESS SOURCE*



**K** *BUSINESS SOURCE*



# #8 Business and Specialty Envelopes | Mailroom and Handling

## A Standard White Envelopes

#8, 3-5/8 x 6-1/2 in. Open side. Box of 70.  
HLR 36510 (115006)



## B White Security Envelopes

#8, 3-5/8 x 6-1/2 in. Tinted interior. Open side. Box of 50.  
HLR 36511 (115113)

## C Standard White Envelopes

#8, 3-5/8 x 6-1/2 in. Open side. 24 lb. Box of 1000. FSC® certified.  
SPX 0800440FNL (357087)

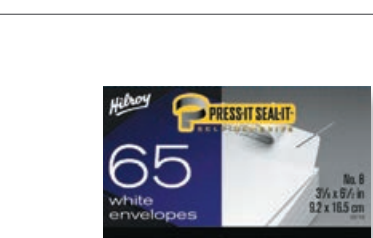

## D Press-It Seal-It® Envelopes

#8, 3-5/8 x 6-1/2 in. Open side. Self-sealing. Box of 65.  
HLR 36710 (456962)

## E Press-It Seal-It® Security Envelopes

#8, 3-5/8 x 6-1/2 in. Tinted interior. Open side. Self-sealing. Box of 55.  
HLR 36711 (456970)

## F Reveal N Seal® Security Envelope

#8, 3-5/8 x 6-1/2 in. Double window. Tinted interior. Open side. Self-sealing. Box of 500.  
QUA 67539 (544114)

## G Redi-Seal Security Envelopes

#8, 3-5/8 x 6-1/2 in. Double window. Tinted interior. Open side. Self-sealing. 24 lb. Box of 500.  
BSN 04650 (1050863)

## H Double Window Security Envelopes

#8, 3-5/8 x 6-1/2 in. Double window. Tinted interior. Open side. 24 lb. Box of 500.  
BSN 42204 (1050897)

## I Income Tax Slip (T4) Envelope

5-3/4 x 9 in. Open side. Security. Box of 500. FSC® certified.  
SPX 9524480 (357343) single window  
SPX 9529480 (357335) double window

## J Redi-Strip™ Card Envelopes

For computer generated cards, greeting cards. Wave paper stock. Self-seal closure. Box of 100. White.  
QUA 10740 (196758) 4-3/8 x 5-3/4 in.  
QUA 10750 (196766) 5-3/4 x 8-3/4 in.

## K White Invitation Envelopes

Open side. Deep flap to print return address. 24 lb. Box of 250. FSC® certified.  
SPXA200440 (291013) 4-3/8 x 5-3/4 in.  
SPXA700440 (291005) 5-1/4 x 7-1/4 in.





**A** **SupremeX**



**B** **SupremeX**

**A Recycled Kraft Envelopes**

Natural. Open end. 24 lb. 50% recycled content, 10% post-consumer waste. Certified FSC®.

- 2-1/4 x 3-1/2 in.  
SPX 109447 (109447) box 1000
- 2-1/2 x 4-1/4 in.  
SPX 109454 (109454) pkg 1000
- 3-1/4 x 4-3/4 in.  
SPX 109462 (109462) box 1000
- 3-1/2 x 6-1/8 in.  
SPX 109488 (109488) box 1000
- 4-5/8 x 6-3/4 in.  
SPX 109512 (109512) pkg 1000
- 4-1/4 x 9-1/2 in.  
SPX 5000420FSC (109496) box 500
- 5-1/2 x 8-1/2 in.  
SPX 6200420FSC (109538) pkg 500
- 5-3/4 x 9-1/2 in.  
SPX 5900420FSC (109504) box 500
- 6-1/2 x 9-1/2 in.  
SPX 18265FSC (290288) pkg 100
- SPX 6300420FSC (109769) box 500
- 7-1/2 x 10-1/2 in.  
SPX 6500420FSC (109777) box 500
- 9 x 12 in.  
SPX 18270FSC (314245) pkg 25
- SPX 18319FSC (290296) pkg 100
- SPX 6700420FSC (109785) box 500
- 9-1/2 x 14-3/4 in.  
SPX 18277FSC (314286) pkg 25
- SPX 18276FSC (314385) pkg 100
- SPX 7000420FSC (109819) box 500
- 10 x 13 in.  
SPX 18272FSC (314278) pkg 25
- SPX 18125FSC (314351) pkg 100
- SPX 6800420FSC (109793) box 500
- 11-1/2 x 14-1/2 in.  
SPX 6900420FSC (109801) box 500
- 12 x 16 in.  
SPX 109827 (109827) box 250
- 15 x 18 in.  
SPX 18030FSC (290262) pkg 10
- SPX 109835 (109835) box 250
- SPX 7500320FSC (543207) box 250 (32 lb)



**C** **SupremeX**



**D** **SupremeX**



**E** **Hilroy**

**B Kraft Expandable Envelopes**

1 in. expansion. Open end. Box of 250. 32 lb. FSC® Certified.

- SPX 6720320FSC (291047) 9 x 12 in.
- SPX 6820320FSC (291039) 10 x 13 in.
- SPX 8420320FSC (516880) 9-1/2 x 15 in.

**C White Catalogue Envelopes**

Open end. 24 lb. FSC® certified.

- 9 x 12 in.  
SPX 0018296 (314229) pkg 100
- SPX 6700440FSC (314237) box 500
- 10 x 13 in.  
SPX 0018253 (291070) pkg 100
- SPX 685982 (685982) box 500



**F** **TOPS PRODUCTS**



**G** **TOPS PRODUCTS**



**D Press to Seal Catalogue Envelopes**

Natural kraft. Open end. Latex gummed flap. Press to seal. 24 lb. 100% post-consumer waste. FSC® certified.

- 9 x 12 in.  
SPX 18208FSC (314500) pkg 100
- SPX 291062 (291062) box 500
- 10 x 13 in.  
SPX 18210FSC (314526) pkg 100
- QUA C0736 (291054) box 500

**F ClearClasp® Envelope**

Feature resealable Redi-Tac technology on the closure for better repeated use and durability. Kraft paper. 28 lb. Box of 100.

- QUA 43568 (1052976) 9 x 12 in.
- QUA 43768 (1052984) 10 x 13 in.

**G Redi-Seal Envelope**

Self-seal, no moisture required to seal. End opening. 24 lb. Box of 100. Made of 100% post-consumer waste. Natural kraft. #7. 9 x 12 in.

- QUA 44563 (165621)

**E Press-It Seal-It® Kraft Envelope**

Self-adhesive, no need to moisten. Kraft paper.

- 5-7/8 x 9 in.  
HLR 76073 (537159) pkg 6
- HLR 76042 (546598) pkg 30
- 9 x 12 in.  
HLR 76077 (537167) pkg 5
- HLR 76044 (100362) pkg 25
- 10 x 13 in.  
HLR 76046 (100370) pkg 20

## A White Catalogue Envelopes

6-1/2 x 9-1/2 in. Open end. 24 lb. Box of 500.  
BSN 42117 (1050582)



## B Kraft Catalogue Envelopes

Open end. 24 lb. Box of 250.  
BSN 42099 (1050590) 6 x 9 in.  
BSN 42104 (1050624) 9 x 12 in.



## C Kraft Catalogue Envelopes

Open end. 28 lb. Box of 250.  
BSN 42100 (1050616) 9 x 12 in.  
BSN 42114 (1050830) 9-1/2 x 12-1/2 in.  
BSN 42101 (1050574) 10 x 13 in.  
BSN 42115 (1050814) 10 x 15 in.  
BSN 42116 (1050822) 11-1/2 x 14-1/2 in.

## D Self Sealing Catalogue Envelopes

Open end. Self-adhesive, no need to moisten. 28 lb.

### White - box of 100

BSN 42122 (1050798) 6 x 9 in.  
BSN 65450 (1050715) 9 x 12 in.  
BSN 65451 (1050707) 10 x 13 in.

### Kraft - box of 250

BSN 42120 (1050806) 9 x 12 in.  
BSN 42121 (1050780) 10 x 13 in.



## E Press-to-Seal Envelope

Press flap to seal. 28 lb. Box of 100.  
BSN 42123 (1050905) 9 x 12 in.  
BSN 42124 (1050913) 10 x 13 in.

## F Coin Envelope

Self-sealing. Open end. 20 lb (3-1/2 x 6-1/6 in. size, 28 lb). Box of 500.

BSN 04440 (1050665) 2-1/4 x 3-1/2 in.  
BSN 04441 (1050673) 2-1/2 x 4-1/4 in.  
BSN 04443 (1050681) 3-1/8 x 5-1/2 in.  
BSN 04446 (1050699) 3-1/2 x 6-1/2 in.



## G Kraft Envelope

Open end. 24 lb.  
5-7/8 x 9 in.  
HLR 76134 (680082) pkg 30  
9 x 12 in.  
HLR 76140 (680033) pkg 5  
HLR 76144 (680041) pkg 25  
10 x 13 in.  
HLR 76136 (680058) pkg 20

## H Kraft Catalogue Envelope

17 x 22 in. Open end. 28 lb. Package of 25.  
QUA 42356 (196006)

## I Redi-Strip™ Kraft Expansion Envelopes

2 in. expansion. Self-adhesive closure. Open end. 40 lb.  
Package of 25.  
QUA 93334 (537142) 9 x 12 in.  
QUA 93336 (564419) 10 x 13 in.  
QUA 93338 (539387) 10 x 15 in.

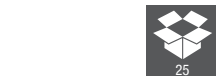

# SupremeX Has The Solution For All Your Packaging Needs

## Conformer® Corrugate Mailers

- Environmentally friendly - 100% recyclable
- 2" expansion
- Tamper-evident secure closure that will not open during shipment
- E.Z. Open Tearstrip
- Rigid construction provides the ultimate strength to protect contents during shipment
- Patented design provides 360° perimeter protection
- Ideal for photos, books, DVDs and anything that requires extremely durable protection.



## EverTec™ Cushioned Mailers

- 100% curbside recyclable!
- Eco-Friendly Sustainable Solution
- 4-ply 40lb Kraft + EverTec™ Cushioning Material
- 2" Flap · Peel & Seal/Tear String Opening
- Better protects enclosed product by helping to absorb shock
- Ideal option to move from single-use plastic mailers
- Ship anything that needs cushioned protection while showing your commitment to the environment



## Conformer® Heavy Duty Mailers

- Extremely durable and versatile capacity means fewer SKU's required
- Tamper-evident secure closure that will not open during shipment
- Ultimate strength to protect product during shipment
- Environmentally friendly - 100%recyclable
- Patented design provides 360°perimeter protection
- These mailers are perfect to protect your books, binders, catalogues and photo albums from damage during shipment.



## Conformer® Paperboard Mailers

- Environmentally friendly
- 100% recyclable
- Tamper-evident secure closure that will not open during shipment
- Convenient E.Z. Open tab eliminates the use of sharp utensils
- Patented design provides 360°perimeter protection

## Courier Mailers

- Rigid 12 point board ensures document protection
- Strong release tape seal provides package security that is convenient and easy to use
- Lightweight - reduces storage & mailing costs
- These rigid mailers are great for documents, marketing materials, artwork, certifications and diplomas.





## A Conformer® Heavy-Duty Mailers

Extremely durable and versatile. Tamper-evident secure closure. Open end. 100% recyclable. Package of 10.  
**SPX HDC1X-10** (832944) 7-1/4 x 10-1/4 in.  
**SPX HDC5X-10** (832945) 9 x 12 in.  
**SPX HDC2X-10** (832946) 9-3/4 x 12-3/4 in.  
**SPX HDC4X-10** (832948) 13 x 18 in.



## B Conformer® Light-Duty Mailers

Tamper-evident secure closure. Open end. 100% recyclable. Package of 25.

**White - package of 10**  
**SPX CD-10** (314633) 6-5/8 x 7-1/4 in.  
**SPX C1-10** (314609) 7-3/8 x 9-5/8 in.  
**SPX C2-10** (314617) 9-3/4 x 12-1/4 in.

**White - package of 25**  
**SPX C0-25** (832949) 6 x 9-1/2 in.  
**SPX C1-25** (832950) 7-3/8 x 9-5/8 in.  
**SPX C2-25** (832952) 9-3/4 x 12-1/4 in.  
**SPX C3-25** (832954) 10-1/2 x 12-3/4 in.  
**SPX C4-25** (832955) 11-1/2 x 13-3/4 in.

**Kraft - package of 25**  
**SPX K1-25** (832951) 7-3/8 x 9-5/8 in.  
**SPX K2-25** (832953) 9-3/4 x 12-1/4 in.



**A** **SupremeX**



**B** **SupremeX**



## C Courier Mailers

Lightweight to reduce storage and mailing costs. Rigid 12-pt recycled board. Strong release tape seal. Package of 25. Brilliant white.  
**SPX 8718260-25** (832957) 9-1/2 x 12-1/2 in.  
**SPX 8718260-25** (832956) 9-1/2 x 15 in.

## D Conformer® Corrugate Mailers

Rigid construction provides ultimate strength. 2 in expansion. Tamper-evident secure closure. 100% recyclable.

**Sold by each**  
**SPX CTB** (314625) 12-1/1 x 14-1/2 in.  
**Package of 10**  
**SPX CPB-10** (832958) 9-1/4 x 12-1/4 in.  
**SPX CTB-10** (832959) 12-1/1 x 14-1/2 in.



## E Conformer® Mailer

Corrugated paperboard. Affordable solution to replace small parcels. Open end with adhesive strip. 13 x 18 in. Package of 25.  
**CWH ZM1318** (239178)

## F Gator-Pak™ Lite Envelope

Heavy-duty cardboard. Self-sealing. Prevents flat items from bending and creasing. Sold by each. White.  
**CWH 740183** (740183) 6 x 8 in.  
**CWH 740191** (740191) 9 x 11-1/2 in.  
**CWH 740209** (740209) 12-1/2 x 9-1/2 in.

**C** **SupremeX**



**D** **SupremeX**



**E** **CROWN HILL**  
PACKAGING LTD.



**F** **CROWN HILL**  
PACKAGING LTD.



**A EverTec™ Cushioned Mailers**

100% curbside recyclable. 4-ply, 40 lb kraft + EverTec™ cushioning material. 2 in. flap. Peel and Seal with tear string opening. Package of 25.  
**SPX EPIX0XET25** (832940) 7 x 9-3/8 in.  
**SPX EPIX2XET25** (832941) 9-1/2 x 12 in.  
**SPX EPIX5XET25** (832942) 12 x 15-1/4 in.  
**SPX EPIX6XET25** (832943) 14 x 18 in.

**B Recyclable Padded Mailers**

Eco-friendly paper-based envelopes and protective padding. Lined with an innovative honeycomb paper structure. Made of recycled paper and fully recyclable. Box of 80.  
**SPL 2SL** (829721) 9-7/8 x 9-1/2 in.  
**SPL 5** (829722) 9-7/8 x 15-1/2 in.  
**SPL 6** (829723) 11-7/8 x 18-1/2 in.

**C Jiffy™ Bubble Mailing Envelopes**

Heavy Kraft paper. Bubble plastic. Peel and seal closure. 100% recycled content; 15% post-consumer waste.

**Package of 25**

**SEL 100007483** (319822) #000 - 4 x 8 in.  
**SEL 100007492** (319830) #00 - 5 x 10 in.  
**SEL 100007493** (319848) #0 - 6 x 10 in.  
**SEL 100007494** (319855) #1 - 7-1/4 x 12 in.  
**SEL 10188CEX** (319871) #3 - 8-1/2 x 14-1/2 in.  
**SEL 10189CEX** (319889) #4 - 9-1/2 x 14-1/2 in.

**Box of 50**

**SEL 39097** (319590) #6 - 12-1/2 x 19 in.  
**SEL 39098** (319608) #7 - 14-1/4 x 20 in.

**Box of 250**

**SEL 55304** (340307) #000 - 4 x 8 in.

**D Jiffy™ Padded Mailing Envelope**

Recyclable with mixed paper. Peel and seal closure. Sold by each. 90% recycled content; 50% post-consumer waste. SFI certified.

**SEL SSPM2** (319616) #2 - 8-1/2 x 12 in.  
**SEL SSPM4** (319624) #4 - 9-1/2 x 14-1/2 in.  
**SEL JIFFY5** (319632) #5 - 10-1/2 x 16 in.  
**SEL JIFFY6** (319640) #6 - 12-1/2 x 19 in.  
**SEL JIFFY7** (319657) #7 - 14-1/4 x 20 in.

**E Ecolite Shipping Envelopes**

Bubble lining. 1/8" Self-sealing. Box of 25.

**CWH 139089-000** (139089) #000 - 4 x 8 in.  
**CWH 139097-00** (139097) #00 - 5 x 10 in.  
**CWH 139105-0** (139105) #0 - 6 x 10 in.  
**CWH 139113-1** (139113) #1 - 7-1/4 x 12 in.  
**CWH 139121-2** (139121) #2 - 8-1/2 x 12 in.  
**CWH 139139-3** (139139) #3 - 8-1/2 x 14-1/2 in.  
**CWH 139147-4** (139147) #4 - 9-1/2 x 14-1/2 in.  
**SEL 10190CEX** (139154) #5 - 10-1/2 x 16 in.  
**CWH 139170-6** (139170) #6 - 12-1/2 x 19 in.  
**CWH 139188-7** (139188) #7 - 14-1/2 x 20 in.

**F Airjacket Poly Bubble Envelope**

Made from a durable, moisture and tear resistant, multilayer blend of co-extruded polyethylene film. Exterior film is laminated to a resilient interior bubble material for effective cushioning. With bottom fold and strong side heat seals for superior strength. 9-1/2 x 13-3/4 in. Sold by each. White.

**PWW 740365** (1051424)

**A** **SupremeX**



**B** **CURBY**



**C** **Sealed Air**



**D** **Sealed Air**



**E** **CROWN HILL PACKAGING LTD.**



**F** **Sealed Air**

## A Courier Bags

Polyethylene. White, grey interior. Self-seal closure. 2.5 mil thick.  
**Package of 100**  
**CWH 139378** (196428) 9 x 12 in.  
**CWH 139386** (196436) 10 x 13 in.  
**CWH 139394** (196451) 12 x 15-1/2 in.  
**CWH 139360** (196410) 14-1/2 x 19 in.  
**Box of 125**  
**CWH PJ7** (551994) 19 x 24 in.



## B Tyvek® Envelopes

End opening. Peel and seal closure. Made of tear-resistant Tyvek®. White. 25% post-consumer waste.  
**Package of 50**  
**SPX 67182205T** (290973) 9 x 12 in.  
**SPX 68182205T** (290965) 10 x 13 in.  
**Package of 100**  
**QUA R1660** (290957) 10 x 15 in.

## C Tyvek® Expanding Envelopes

End opening. Peel and seal closure. Made of tear-resistant Tyvek®. White. 25% post-consumer waste.  
**Package of 25 - 1-1/2 in. expansion**  
**SPX 68202202T** (290940) 10 x 13 in.  
**Package of 100 - 2 in. expansion**  
**SPX 7220220T** (290304) 12 x 16 in.



## D Tyvek® Envelopes

Lightweight, moisture and rip-resistant Tyvek®. Self-adhesive closure. White. Box of 100.  
**No expansion**  
**QUA R1790** (564427) 12 x 15-1/2 in.  
**1-1/2 in. expansion**  
**QUA R4500** (410431) 10 x 13 in.  
**2 in. expansion**  
**QUA R4520** (1052919) 12 x 16 in.



## E Inter-Department Envelopes

Self-adhesive fastener. Natural Kraft. 10 x 13 in. Bilingual. 32 lb. 60% recycled content. FSC® certified.  
**SPX 18043FSC** (291104) pkg 25  
**SPX 10096FSC** (291096) pkg 100

## F Inter-Department Envelopes

String and button closure. Brown kraft. 10 x 13 in. 6 view holes. String and button closure. 32 lb. Bilingual. 60% recycled content. FSC® certified.  
**SPX 18040FSC** (291120) pkg 25  
**SPX 6885320FSC** (291112) box 200

## G Inter-Department Envelope

Polypropylene. Includes 2 sheets with names. 10 x 15 in. Bilingual. Blue.  
**WNN EN-12DB** (791624)





**A** **Winnable**



**B** **GEOCAN**  
CONCEPTION & DESIGN

**A SlideLock® Envelope**

Polypropylene. Zippered closure. Clear front pocket. Expanding 1-1/4 in. gusset. Letter size. Sold by each. Assorted colours.  
**WNN ENZ-11-AD** (107367)

**B Translucent Polyethylene Envelope**

Expands up to 1-1/4 in. String tie. Sold by each.  
**Open side - 9 x 12 in.**  
**GCI W80010** (627851) clear  
**Open end - 9-3/4 x 13-1/2 in.**  
**GCI W90011** (301846) blue  
**GCI W90012** (301853) red  
**GCI W90017** (107326) assorted colours  
**Open end - 10 x 14-1/2 in.**  
**GCI W90010** (301838) clear



**C** **Winnable**



**D** **Winnable**

**C Translucent Expanding Envelope**

Polypropylene. Open end. String tie. Letter size. 9-1/2 x 13 in. with up to 1-1/4 in. expansion. Sold by each.  
**WNNEN01-CR** (740258) clear  
**WNN EN01-BE** (115287) blue  
**WNN EN01-GN** (196691) green  
**WNN EN01-PE** (196709) purple  
**WNN EN01-RD** (115295) red



**D Translucent Expandable Envelope**

Polypropylene. Open side. Expands up to 1-1/4 in. Sold by each.  
**String tie**  
**WNN EN04-CR** (740282) 9-1/2 x 5 in.  
**WNN EN02-CR** (740266) letter  
**WNN EN03-CR** (740274) legal  
**Velcro closure**  
**WNN EN05-CR** (740407) letter

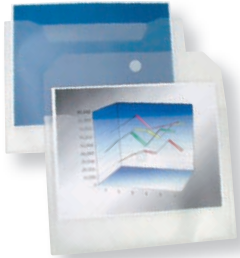

**E** **Winnable**



**F** **Winnable**

**E Document Envelope**

Polypropylene. Frosted. Open side. Inside and outside pockets. Flap to protect documents. Velcro closure. Letter size. Sold by each.  
**WNN EN-10S-CR** (740415) clear  
**WNN EN10BE-PK** (791566) blue  
**WNN EN10GN-PK** (791574) green  
**WNN EN10OR-PK** (791582) orange  
**WNN EN10PE-PK** (791590) purple  
**WNNEN10PI-PK** (240903) pink  
**WNN EN10YW-PK** (791616) yellow



**F SlideLock® Envelope**

Polypropylene. Zippered closure. Clear front pocket. Expanding 1-1/4 in. gusset. Archival safe. Acid and lignin free. Sold by each.  
**WNN ENZ-510CR** (115329) 5 x 10 in.  
**WNN ENZ11-CR** (760223) 10 x 13 in.  
**WNN ENZ-15CR** (791632) 10 x 15 in.  
**WNN ENZ-17-CR** (456673) 12 x 18-1/2 in.



**G** **GEOCAN**  
CONCEPTION & DESIGN



**H** **vlb**

**G Document Envelope**

Polypropylene. Frosted. Side opening. Flap to protect documents. Snap button closure.  
**Letter size**  
**GCI G006** (783076) assorted colours  
**Legal size**  
**GCI G008** (107318) clear



**H Document Envelope**

Polypropylene. Frosted. 2 pockets. Snap button closure. 13-1/2 x 9 in.  
**Sold by each**  
**VLB 90973** (162560) snow  
**VLB 90971** (162545) blueberry  
**VLB 90972** (537209) strawberry  
**VLB 90974** (545509) grape  
**VLB 90975** (545582) lime  
**VLB 90976** (545533) yellow  
**Package of 6**  
**VLB 90970** (425538) charcoal



**I Expandable Poly Envelope**

Open-end. Velcro closure. Business card holder. Expands up to 1-3/4 in. or 300 sheets of paper. Letter size. Clear. Sold by each.  
**WNN EN25-CR** (1051572)

**I** **Winnable**

## A KleenEarth® Antimicrobial Letter Opener

Plastic parts contain an antimicrobial agent to help to inhibit the growth of bacterial odours. Precision ground stainless steel blades. Contoured handle is made of 70% recycled materials and 30% post-consumer content. 10-year warranty.

ACM 14821 (138453)



**A** WESTCOTT  
Depuis 1872 Since 1872



**B** WESTCOTT  
Depuis 1872 Since 1872

## B Titanium Bonded® Letter Opener

The Titanium Bonded® blade is 3 times stronger than stainless steel. Corrosion resistant from acids, chlorides and salt water for a longer blade life. Contoured soft grip handle. Lifetime warranty.

ACM 13950 (774729)

## C Stainless Steel Letter Opener

Sturdy durable construction. 9 in blade.

ACM 29349 (139063)



**C** WESTCOTT  
Depuis 1872 Since 1872

## D Mini Zip Style Letter Opener

Constructed of durable, lightweight polypropylene. Concealed blade.

ACM 00297 (395079) by each

ACM 02972 (240341) pkg 2



**D** WESTCOTT  
Depuis 1872 Since 1872

## E Cup Moistener With Sponge

Acrylic cup with polyurethane sponge.

ACM 10051 (198028) complete set

ACM 10052 (198036) sponge only



**E** WESTCOTT  
Depuis 1872 Since 1872

## F Sortkwik® Moistener

Moistens the fingers for an easy grip in handling paper. Stainless, odourless and greaseless. Non-toxic. 10 g.

ACM 10050 (198044)



**F** WESTCOTT  
Depuis 1872 Since 1872

## G Bottle Moistener

Squeezable plastic container with pointed tip sponge moistener.

Easy sealing. Easy-to-fill bottle.

ACM 10054 (491175)

## H Tube Style Bottle Moistener

Squeezable plastic container with sponge moistener. Make sealing envelopes and moistening stamps easy. Easy-to-fill bottle.

ACM 10053 (491167) pointed sponge

ACM 10057 (674028) roll sponge

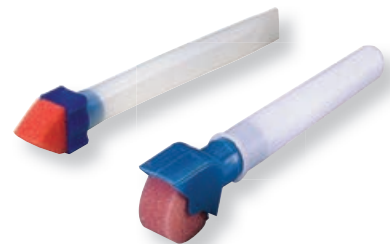

**G** WESTCOTT  
Depuis 1872 Since 1872

**H** WESTCOTT  
Depuis 1872 Since 1872

## I Non-Ventilated Finger Tips

Deluxe-grade rubber and moulded shape assure positive grip and long wear. Heavy duty. Non-ventilated. Box of 12. Amber.

ACM00710 (659847) #00 (very small)

ACM00711 (659839) #0 (small)

ACM00712 (659821) #1 (medium)

ACM00713 (659813) #2 (large)

ACM00714 (659805) #3 (x-large)

ACM00715 (546762) assorted sizes



**I** WESTCOTT  
Depuis 1872 Since 1872

## J Rubber Finger Tips

Made of natural latex. Box of 12. Amber.

SWI 54031 (760785) #00 (small) 9/16 in.

SWI 54035 (760819) #0 (medium) 5/8 in.

SWI 54032 (760793) #1 (medium /large) 11/16 in.

SWI 54033 (760801) #2 (large) 3/4 in.

SWI 54014 (760777) #3 (x-large thumb) 7/8 in.



**J** WESTCOTT  
Depuis 1872 Since 1872

## K Ventilated Finger Tips

Deluxe-grade rubber and moulded shape assure positive grip and long wear. Light duty. Box of 12. Red.

ACM00700 (229351) #00 (extra small) 9/16 in.

ACM00701 (229476) #0 (small) 5/8 in.

ACM00702 (659870) #1 (medium) 11/16 in.

ACM00703 (229534) #2 (large) 3/4 in.

ACM00704 (229542) #3 (extra large) 15-16 in.



**K** WESTCOTT  
Depuis 1872 Since 1872

Find Envelope Sealers on  
page 567



**A**  **CROWN HILL PACKAGING LTD.**

**A Shipping Box**

Corrugated cardboard. Perfect for storage and shipping parcels. Up to 175 lb capacity.

- Sold by each**  
**CWH 80525** (1049386) 18 x 12 x 12 in. H  
**Package of 10**  
**CWH 161851** (161851) 6 x 6 x 6 in. H  
**CWH 800250** (161877) 11 x 9 x 9 in. H  
**CWH 080125** (161752) 11-3/4 x 8-3/4 x 4-3/4 in. H  
**CWH 161836** (161836) 12 x 8 x 8 in. H  
**CWH 161828** (161828) 12 x 12 x 6 in. H  
**CWH 81212** (161745) 12 x 12 x 12 in. H  
**CWH 08022510PK** (161760) 13-3/4 x 10-1/4 x 9 in. H  
**CWH 161778** (161778) 14 x 14 x 6 in. H  
**CWH 803250** (161869) 14 x 14 x 10 in. H  
**CWH 80425** (161729) 15 x 12 x 10 in. H  
**CWH 100-10PK** (195776) 16 x 13 x 13 in. H  
**CWH 81210-10PK** (161737) 18 x 12 x 10 in. H  
**CWH 101-10PK** (195735) 18 x 15 x 12-1/2 in. H  
**CWH 161786** (161786) 18 x 18 x 12 in. H  
**CWH 152-10PK** (198945) 18 x 18 x 16 in. H  
**CWH 161794** (161794) 18 x 18 x 18 in. H



**B**  **BANKERS BOX**

**B Storage and Shipping Box**

Letter or legal size (12 x 15 x 10 in. H). Double-layer bottom. Adhesive strip for secure box seal with tab for access. Stackable up to 500 lbs. 65% recycled content, 59% post-consumer waste. SFI certified. **FEL 0007101** (755157)



**C**  **CROWN HILL PACKAGING LTD.**



**D**  **CROWN HILL PACKAGING LTD.**



**E**  **CROWN HILL PACKAGING LTD.**



**D Shipping Boxes**

Pre-folded corrugated cardboard. 11-1/2 x 11-3/4 x 3 in. H. Package of 5. 94% recycled content. **CWH 81113** (146720)

**E Part Bin**

Corrugated cardboard. Step down sides. Label area and printed control inventory chart.

- CWH 37450** (146597) 4 x 12 x 4 in. H  
**CWH 37465** (146605) 6 x 12 x 4 in. H  
**CWH 37470** (146613) 6 x 18 x 4 in. H  
**CWH 37475** (146621) 8 x 12 x 4 in. H

**F Square Mailing Tube**

100% recycled kraft. heavy-duty construction tested to 200 lbs. Won't roll off moving surfaces such as conveyor belt. 3 x 3 in. White. **CWH TUBE325** (312041) 25 in. **CWH TUBE330** (312629) 30 in.



**F**  **CROWN HILL PACKAGING LTD.**



**G**  **CROWN HILL PACKAGING LTD.**



**G White Shipping Tube**

3 inch diameter. **CWH TUBE324W** (161919) 24 in. **CWH TUBE336W** (161935) 36 in. **CWH TUBE348W** (161950) 48 in.

**H Shipping Tube**

Kraft cardboard. 2 inch diameter. Folded ends. 100% recycled content. **CWH TUBE218-25** (195800) 18 in. **CWH TUBE224-25** (195834) 24 in. **CWH 291260** (291260) 30 in.



**H**  **CROWN HILL PACKAGING LTD.**

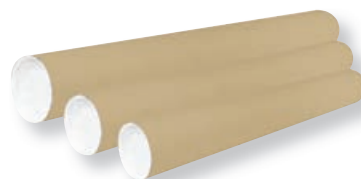

**I**  **CROWN HILL PACKAGING LTD.**



**I Mailing Tubes With End Cap**

Heavy-duty, brown Kraft tubes with end caps. 2 inch diameter. 100% recycled kraft.

- CWH 339259** (339259) 24 in.  
**CWH 343046** (343046) 36 in.  
**CWH TUBE348K** (325951) 48 in.

## A Box Lock™ Packaging Tape Dispenser

Sticks instantly to any box. Tape ensures boxes stay securely sealed during rough handling. This tape can be used to seal any type of box, including 100% recycled boxes, 48 mm x 20.3 m.

MMM 195-EF (829447)

• Refill - 48 mm x 50 m

MMM 3950LR3EF (829438) pkg 3



## B Curby® Mini-Taper Manual Tape Dispenser

Compact, portable and easy-to-operate manual water-activated tape dispenser. Ideal for small office or home office, retail outlets and low-volume shipping environments with limited workspace. Grey.

SPL 222 (829727)

• Refill - 70 mm x 100 m

SPL 304 (829726)

## C Antimicrobial Tape Gun

Plastic parts contain an antimicrobial agent to help inhibit the growth of bacterial stains and odours. Retractable blade. Heavy duty, lightweight construction. Adjustable clutch. 3 in core.

ACM 80017 (827916)

## D Scotch® Box Sealing Tape Dispenser

For packing tape of 48 mm. Tape not included.

MMM H180 (302133)

## E Box Sealing Tape Dispenser

Durable dispenser holds 3 in. core tape up to 2 in. wide and 60 yards long. Retractable blade. For packing tape of 48 mm. Tape not included.

MMM HB903 (1049725)

## F Packing Tape Dispenser

Heavy-duty and lightweight. Adjustable clutch. Refillable. Holds 2 in (48mm) roll of tape. Tape not included.

ACM 80016 (243543)

## G Scotch® Heavy-Duty Packaging Tape

With hand held dispenser. Super strong acrylic tape. 20x stronger than acrylic tapes. 48 mm x 20.3 m.

MMM 142ESF (115253)

## H Tough Grip Moving Packaging Tape

With hand held dispenser. Super-strong adhesive for moving and packaging. Securely seal moving boxes up to 80 lb. 48 mm x 20.3 m.

MMM 150-ESF (1049816)





**A** **Scotch**



**B** **Scotch**

**A Scotch® Moving Tape**

Secures boxes up to 80 lbs. Tough grip. Smooth and quiet unwind. Hot melt adhesive. Transparent. 48 mm x 50 m.  
**MMM 3500-ESF** (429936) by each  
**MMM 3500-3-ESF** (429944) pkg 3  
**MMM 3500-6-ESF** (429951) pkg 6

**B Scotch® Heavy-Duty Shipping Tape**

40X stronger than regular acrylic tapes. Seals seams with one strip and keeps boxes closed. Resists slivering, splitting and tearing. Hot melt adhesive. Transparent. 48 mm x 50 m.  
**MMM 3850-ESF** (429969) by each  
**MMM 3850-3-ESF** (429977) pkg 3  
**MMM 3850-6-ESF** (429985) pkg 6

**C Scotch® Long Lasting Storage Packaging Tape**

Designed with a long-lasting adhesive. UV and sunlight resistant. Withstands conditions in extreme temperatures. Resists slivering, splitting and tearing. 48 mm x 50 m. Package of 6. Clear.  
**MMM 3650-6ESF** (573980)



**C** **Scotch**



**D** **3M**

**D Tartan™ Packaging Tape**

For sealing. Hot melt adhesive. 48 mm x 50 m. Package of 6. Clear.  
**MMM 3690C-6PK** (147546)

**E Scotch® Packaging Tape**

Ideal for light and medium duty packaging applications. Hot melt adhesive. 48 mm x 100 m. Clear.  
**MMM 775171** (775171) by each  
**MMM 3250-6-EF** (829449) pkg 6

**F Offix® Packaging Tape**

For light-duty storage and sealing applications. Package of 6.  
**NVX 347922** (347922) 48 mm x 50 m  
**NVX 347948** (347948) 48 mm x 100 m

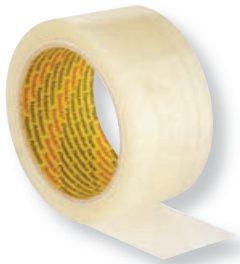

**E** **Scotch**



**F** **offix**



**G Sealing Tape Printed FRAGILE**

Transparent. Trilingual. 48 mm x 100 m. Sold by each.  
**MMM 420885** (420885)

**H Printed Sealing Tape**

Preprinted; "If seal is broken check contents before accepting". Red text with white tape. 48 mm x 100 m. Sold by each.  
**MMM 3771** (1049759)

**I Scotch® Super-Hold Tape**

50% more adhesive than the standard transparent tape. Great for small repairs, sealing envelopes and securing small packages. 19 mm x 16.5 m. Vendu à l'unité.  
**MMM 198ESF** (573972)



**G** **Scotch**



**H** **Scotch**



**I** **Scotch**



## A Cushion Lock™ Protective Wrap

Replaces the need for traditional plastic cushion and void fill. Expands up to 60x its original volume. Designed pattern interlocks upon itself, eliminating the need for tape. Recyclable paper. 100% recycled content.

MMM PCW1230EF (829505) 12 in. x 30 ft.

MMM PCW121000 (829504) 12 in. x 1000 ft.

• Dispenser

MMM PCW121000D (829503)

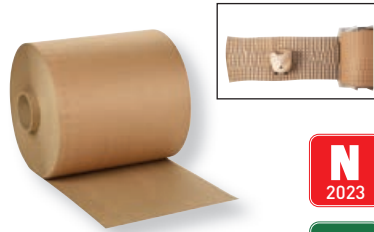

## B Fragile Wrap Material

Engineered void fill for maximum cushioning protection. Interlocking honeycomb design reduces shifting. 100% recyclable. Eliminates movement of product during transport. Made from recyclable paper. 15-1/4 x 25 in sheets. Package of 25.

SPL 300 (829724)



## C Void Fill Material

Interlocking honeycomb design reduces shifting. 100% recyclable. Eliminates movement of product during shipping. Designed so it won't flatten during shipping. Made from recyclable paper. 12 in. X 1000 ft. Dispenser box.

SPL 314 (829725)



## D Kraft Wrapping Paper

Perfect for wrapping and covering boxes, protect your products from damage, dirt and scratches.

30 lb

SPL MFRNAT3024 (1066141) 24 in. x 1200 ft.

SPL MFRNAT3030 (1066159) 30 in. x 1200 ft.

40 lb

SPL MFRNAT4024 (1073626) 24 in. x 900 ft.

SPL MFRNAT4030 (1073634) 30 in. x 900 ft.

SPL MFRNAT4036 (1065896) 36 in. x 900 ft.

• Dispenser

SPL KRADISP24 (1066125) 24 in.

SPL KRADISP36 (1066133) 36 in.



## E Brown Kraft Wrapping Paper

30 in. wide, 20 ft. long. 60 lb.

DUC 00-1037001 (698407)

## F Brown Kraft Wrapping Paper

Ideal for shipping and wrapping. 40 lb. 100% recycled content; 50% post-consumer.

CWH 80003 (146670) 30 in. x 39-3/8 ft.

CWH DD40936 (311753) 36 in. x 900 ft.

## G White Wrapping Paper

Ideal for filling packaging voids, in both the warehouse and mail room. 40 lb. 30 in. x 720 ft. White.

CWH DD4030W (1049592)

## H Protective Bubble Wrapping

By roll. Perforated every 12 inches for tearing of desired length.

3/16 in. bubbles.

CWH 80000 (146654) 12 in. x 25 ft.

CWH 80001 (1049576) 16 in. x 9 ft.

## I Protective Bubble Wrapping

Dispenser box. Perforated every 12 inches for tearing of desired length. 12 in. wide.

CWH 85100 (196360) 5/16 in. bubble x 100 ft.

CWH 83175 (146738) 3/16 in. bubble x 175 ft.

## J Green Bubble Wrap

12 inch perforated sheets. Environmentally responsible. 3/16 in. bubbles. 12 in. x 25 ft. 40% recycled content; 20% post-consumer.

CWH 83666 (291203)

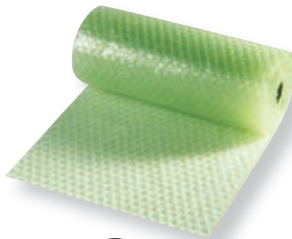

## K UPS Friendly Bubble Wrap

Courier-friendly wrap. Great for protecting fragile items. Perforated every 12 inches.

3/16 in. bubbles

CWH 291294 (291294) 12 in. x 300 ft.

CWH 291302 (291302) 24 in. x 300 ft.

5/16 in. bubbles

CWH 291310 (291310) 12 in. x 188 ft.

CWH 291328 (291328) 24 in. x 188 ft.

## L Bubble Wrap

Superior protection for fragile, valuable items with long ship cycles. 1/2 inch thick. 24 in x 250 ft. roll.

CWH B1-2S24 (370361)



   <p><b>A</b> <b>CROWN HILL</b> PACKAGING LTD.</p>	 <p><b>B</b> <b>Spicers</b></p>	  <p><b>A Newsprint Packaging</b> 24 x 36 in. sheets. Package of 50. <b>CWH 82436</b> (178012)</p> <p><b>B Newsprint Fill Paper</b> Roll. 24 in. x 1200 ft. <b>SPL NEWSR24</b> (556670)</p> <p><b>C Reclosable Zipper Bags</b> Plastic bag with zip closure. Ziploc style. Package of 100. <b>DDN 0795050</b> (302091) 3 x 5 in. <b>DDN 0795070</b> (302109) 4 x 6 in. <b>DDN 0795100</b> (302117) 5 x 8 in. <b>DDN 302125</b> (302125) 6 x 9 in. <b>DDN 0795170</b> (609495) 8 x 10 in. <b>DDN 0795180</b> (609503) 9 x 12 in. <b>DDN 0795210</b> (609479) 12 x 15 in.</p>
  <p><b>D</b> <b>CROWN HILL</b> PACKAGING LTD.</p>	   <p><b>E</b> <b>CROWN HILL</b> PACKAGING LTD.</p>	  <p><b>D Reclosable Zipper Bags</b> Clear with white block for content labelling and identification. Package of 100. <b>CWH 80023</b> (523118) 2 x 3 in. <b>CWH 80035</b> (601856) 3 x 5 in. <b>CWH 80046</b> (537225) 4 x 6 in. <b>CWH 80069</b> (545368) 6 x 9 in. <b>CWH 80912</b> (537233) 9 x 12 in.</p> <p><b>E Envelope Insert</b> Padding board used for mailing documents, photos without worry of bending. 8-1/2 x 11 in. Package of 25. 90% post-consumer content. <b>CWH 80025</b> (146704)</p> <p><b>F Recycled Backer Boards</b> 25 mil. Letter size. Package of 500. <b>SPL PAD802511</b> (348201)</p>
   <p><b>G</b> <b>CROWN HILL</b> PACKAGING LTD.</p>	 <p><b>H</b> <b>CROWN HILL</b> PACKAGING LTD.</p>	 <p><b>I</b></p> <p><b>G Envelope Stiffener Boards</b> 8-1/2 x 14 in. Package of 25. 100% recycled content. <b>CWH 81425</b> (311860)</p> <p><b>H Packing Foam</b> 1/8 inch thick. 12 in. x 175 ft. roll. Dispenser box. <b>CWH 85175</b> (196378)</p> <p><b>I Styrofoam Peanuts</b> For any packaging use. CFC free. Antistatic. 20 ft.cu. bag. <b>DDN 2555050</b> (737148)</p>
 <p><b>J</b> <b>CROWN HILL</b> PACKAGING LTD.</p>	   <p><b>K</b> <b>3M</b></p> <p><b>K Packing Slip Envelopes</b> Permanent adhesive. 4-1/2 x 5-1/2 in. Box of 1000. <b>Transparent window</b> <b>MMM NP-1</b> (100388) <b>Printed bilingual message</b> <b>MMM TC-1</b> (333674)</p>	
  <p><b>L</b> <b>CROWN HILL</b> PACKAGING LTD.</p>	 <p><b>M</b> <b>GEOCAN</b> CONCEPTION &amp; DESIGN</p> <p><b>L Packing Slip Envelopes</b> Waterproof, barcode readable, adheres to virtually all surfaces. Printed bilingual message "PACKING LIST ENCLOSED/BORDEREAU D'EXPÉDITION INCLUS". 4-1/2 x 5-1/2 in. Package of 100. <b>CWH 81145</b> (291245)</p> <p><b>M Packing Slip Envelopes</b> Self-adhesive. Bilingual. <b>Bilingual printed message - 5-1/2 x 4-1/2 in.</b> <b>GCI 90083</b> (485375) pkg 100 <b>GCI 02000</b> (485383) box 1000 <b>Transparent window - 10 x 5-1/2 in.</b> <b>GCI 02100</b> (791467) pkg 100 <b>Transparent window - 13 x 9-1/2 in.</b> <b>GCI 50090</b> (791459) pkg 100</p>	

## A White Identification Tags with String

Package of 50.

- MGE 10247311 (362186) 1-3/4 x 1-3/32 in.
- MGE 10244061 (537332) 1-3/32 x 3/4 in.
- MGE 545624 (545624) 1/2 x 15/16 in.
- MGE 10247291 (362194) 2-3/4 x 1-11/16 in.



**A** MERANGUE

## B Fluorescent Marking Tags

1-7/8 x 1-3/32 in. tags with white strings. Assorted, 25 of each colour, green, orange, pink, yellow.

MGE 10244041 (554857)



**B** MERANGUE

## C Jewellery Tags with Strings

13/16 x 3/8 in. Box of 100.

MGE 10244051 (1049634)

## D White Identification Tags with Strings

Box of 1,000.

- MGE 429159 (429159) 1-3/4 x 1-1/8 in.
- MGE 429167 (429167) 1-29/32 x 1-1/4 in.
- MGE 429175 (429175) 2-5/32 x 1-7/16 in.
- MGE 429183 (429183) 2-7/8 x 1-3/4 in.



**C** MERANGUE

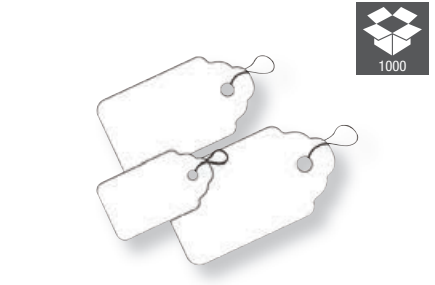

**D** MERANGUE

## E Manila Paper Shipping Labels

Package of 100.

- MGE10244721 (362111) 2-3/4 x 1-3/8 in.
- MGE10245061 (564062) 3-3/4 x 1-7/8 in.
- MGE 10245071 (1049675) 4-1/4 x 2-1/8 in.
- MGE10244711 (362152) 4-3/4 x 2-3/8 in.
- MGE 10245051 (564054) 5-1/4 x 2-5/8 in.

## F Manila Paper Shipping Tags

Reinforced holes keep tags attached without tearing. Package of 100.

- CWH TAG31 (1049642) 3-1/4 x 1-5/8 in.
- CWH TAG42 (1049650) 4-3/4 x 2-3/8 in.
- CWH TAG52 (1049667) 5-1/4 x 2-5/8 in.

## G Manila Paper Shipping Tags

Box of 1000.

- MGE102440700 (429100) 2-3/4 x 1-3/8 in.
- MGE102440900 (429118) 3-3/4 x 1-7/8 in.
- MGE102441000 (429126) 4-1/4 x 2-1/8 in.
- MGE102441100 (429134) 4-3/4 x 2-3/8 in.
- MGE102441200 (429142) 5-1/4 x 2-5/8 in.



**E** MERANGUE



**F** CROWN HILL PACKAGING LTD.

## H Steel Tag Wire

For fastening shipping labels. 12 in. Package of 1000.

CWH 138719 (138719)

## I Shipping Tag Wire

26 gauge steel wire. 12 in. Package of 1000.

MGE 10245091 (539221)

## J All Purpose Fasteners

Ideal for securing tags in place. 5 in. Package of 200.

MGE 10244031 (539213)



**G** MERANGUE



**H** CROWN HILL PACKAGING LTD.



**I** MERANGUE



**J** MERANGUE



**A** Spicers



**B** CROWN HILL PACKAGING LTD.



**A Shipping Labels**

Roll of 500 labels.  
**FRAGILE HANDLE WITH CARE**  
**SPL LABEF101R** (548727) 3 x 5 in.  
**DO NOT STACK**  
**SPLLAB00008** (1049683) 3 x 5 in.  
**GLASS HANDLE WITH CARE**  
**SPLLABEF109** (1049691) 4 x 4 in.  
**MADE IN CANADA**  
**SPL LABRW215R** (1049709) 1 in. diameter

**B Hand Held Stretch Wrap**

5 in. x 1000 ft. Sold by each. 100% recycled content (core).  
**CWH 80005** (146688)

**C Opaque Stretch Wrap**

14 in. x 1500 ft. 80 gauge. Box of 4. Black.  
**CWH 64265** (337980)



**C** CROWN HILL PACKAGING LTD.



**D** Spicers

**D Pallet Stretch Wrap**

For pallet bundling, 14 in. x 1476 ft. Box of 4.  
**SPL PS00492** (1049527) 65 gauge  
**SPL PS00494** (1073600) 80 gauge

**E Pallet Pre-Stretch Wrap**

High-quality design reduces film usage for cost-efficient use.  
 15 in. x 1,476 ft. Box of 4.  
**SPL PS00326** (1049535)

**F Pallet Stretch Wrap**

Durable design that provides 250% pre-stretch for maximum strength.  
 20 in. x 6,500 ft. Sold by each.  
**SPL AXIM003** (1049543)

**G Handheld Stretch Wrap Dispenser**

Heavy-duty construction provides long-lasting use. For use with 12 to 20 in. rolls. Stretch wrap not included.  
**SPL STRWDISP** (1049551)

**H Packing Wrap Dispenser**

Hand saver dispenser features an easy-to-operate design to prevent finger friction burns. Compatible with all 3 in. core stretch wraps.  
**SPL PS00569** (1073618)



**E** Spicers



**F** Spicers



**G** Spicers



**H** Spicers



**I** CROWN HILL PACKAGING LTD.

**I Poly Strapping Kit**

To secure skids and boxes. Polypropylene straps of 1/2 in. x 3300 ft.  
**CWH 014-PC12WB** (601872)



**A** **DYMO**  
and done.

**M5 Digital Postal Scale**  
DYM 1772056 (165787)



**B** **DYMO**  
and done.

**M10 Digital Postal Scale**  
DYM 1772057 (165795)



**C** **DYMO**  
and done.

**M25 Digital Postal Scale**  
DYM 1772059 (165803)



**D** **DYMO**  
and done.

**S100 Digital Postal Scale**  
DYM 1776111 (165829)

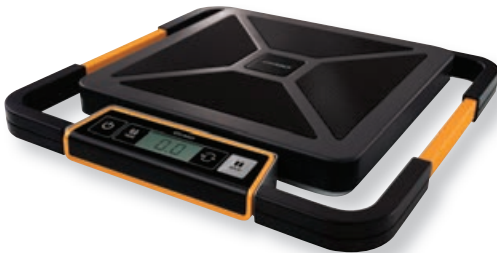

**E** **DYMO**  
and done.

**S250 Digital Postal Scale**  
DYM 1776112 (165837)



**F** **DYMO**  
and done.

**S400 Digital Postal Scale**  
DYM 1776113 (165845)

	M5 DIGITAL POSTAL SCALE	M10 DIGITAL POSTAL SCALE	M25 DIGITAL POSTAL SCALE	S100 DIGITAL USB POSTAL SCALE	S250 DIGITAL USB POSTAL SCALE	S400 DIGITAL USB POSTAL SCALE
<b>DESCRIPTION</b>	5lb Digital Scale	10lb Digital Scale	25lb Digital Scale	100lb Digital Scale	250lb Digital Scale	400lb Digital Scale
<b>LCD SCREEN</b>	-	-	-	Detachable	Detachable	Detachable
<b>BATTERIES</b>	3 AAA (included)	3 AAA (Not included)	3 AAA (Not included)	No	No	No
<b>USB MAC/PC</b>	No	Yes (included)	Yes (included)	Yes	Yes	Yes
<b>AC ADAPTER</b>	-	-	-	Yes	Yes	Yes
<b>TARE WEIGHT</b>	Yes	Yes	Yes	Yes	Yes	Yes
<b>DISPLAY</b>	lbs/oz or Kg/g	lbs/oz or Kg/g	lbs/oz or Kg/g	lbs/oz or Kg/g	lbs/oz or Kg/g	lbs/oz or Kg/g
<b>AUTO SHUT OFF</b>	Yes	Yes	Yes	Yes	Yes	Yes
<b>MANUAL</b>	Included	Included	Included	Included	Included	Included
<b>WARRANTY</b>	1-Year Limited	1-Year Limited	1-Year Limited	1-Year Limited	1-Year Limited	1-Year Limited



**A**  **SAFCO**

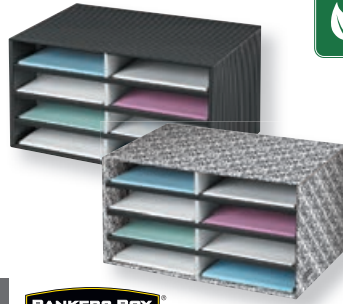

**B**  **BANKERS BOX**

**A Inter-Office Mailbox**

Drop box and office communication. Locking hinged door (2 keys included). Slot opening 10-1/2 x 3/4 in. Overall size 12 x 3 x 12 in. H. Mounting hardware included. Black.  
**SAF 4258BL** (1043173)

**B Mail and Document Sorter**

8 compartments. Ideal for managing lighter workflow while organizing mail, forms, catalogue sheets, etc. 19-1/2 x 12-3/8 x 10-1/4"H. 100% recycled content, 60% post-consumer.  
**FEL 6171301** (22690) brocade  
**FEL 6170301** (229591) pinstripes



**C**  **Fellowes**



**D**  **SAFCO**

**C Literature /Mail Sorter**

5/8 in. particle board frame. Self-adhesive labels included for compartments identification. Holds up to 200 lb. Letter size. Grey.  
**12 compartments - 29 x 11-7/8 x 12-15/16 in. H**  
**FEL 25004** (195966)  
**24 compartments - 29 x 11-7/8 x 23-7/16 in. H**  
**FEL 25041** (399675)

**D Wood Mail Sorter**

1/2 in. compressed wood with laminate finish. 10 adjustable shelves. 12 compartments. Letter size. 19-1/2 x 12 x 16 in. H. Grey.  
**SAF 9420GR** (548289)

**E Mailroom Sorter**

Durable polystyrene. Non-skid rubber feet. Label holder on each pockets. Stackable. Black. 100% post-consumer recycled content.  
**12 compartments - 31-3/8 x 14-1/8 x 10-5/8 in. H**  
**STX 61602B01R** (791541)  
**24 compartments - 31-3/8 x 14-1/8 x 20-1/2 in. H**  
**STX 61611U01C** (196675)



**E**  **STOREX**

**F Utility Cart**

Easy to clean smooth surfaces. Quiet casters and plastic construction help eliminate noise. User-friendly grip handles. 4 swivel casters. 3 shelves. 200 lb capacity. Brushed aluminum uprights. 33-5/8 x 18-5/8 x 37-3/4 in. H. Black.  
**RUB 342488-BK** (196725)

**G 3-Shelf Utility Cart**

Strong wire utility cart transports and stores material safely and efficiently. Cart has an overall weight capacity of 600 lb (200 lb per shelf). Cart rolls smoothly on 4 swivel wheels. 43-3/4 x 19-1/4 x 40-1/2 in. H.  
**SAF 5338BL** (291237)



**F**  **Rubbermaid Commercial Products**



**G**  **SAFCO**

**H Mail Cart**

For 150 files. Can hold hanging files. Steel construction with chrome-finish. Bottom shelf. Front swivel casters. Assembly required. 18 x 38-1/2 x 39-1/4 in. H.  
**FEL 40912** (301945)

**I Mail Cart**

Welded wire construction. Dual handle. Top basket is designed to hold legal file folders (not included). 4 swivel casters, 2 locking. Grey powder coat finish.  
**For 75 folders - 26-3/4 x 18-3/4 x 38-1/2 in. H**  
**SAF 5235GR** (775064)  
**For 150 folders - 39 x 18-3/4 x 38-1/2 in. H**  
**SAF 5236GR** (775072)



**H**  **Fellowes**



**I**  **SAFCO**

Find Stepstools on **page 367**

## A Hide-Away®

### Convertible Hand Truck/Cart

Converts into a 4 wheeled platform. Two 6 in. diameter, solid rubber wheels and two 3 in. casters for easy mobility. Hold 250 lb on 2 wheels and 400 lb of 4 wheels. 15-1/2 x 9 x 36 in. H. Black.  
**SAF 4050** (1055327)

**A** SAFCO



**B** SAFCO



## B Stow and Go Cart™

Telescoping handle with lightweight aluminum frame. Cart folds down to size of briefcase, fits under car seat or in airplane overhead compartment. 5 in. diameter rubber, retractable wheels. Rated up to 110 lbs. 15-3/4 x 16-1/4 x 39-1/2 in. H. Black.  
**SAF 4049NC** (555953)

**C** SAFCO



**D** SAFCO



## C Tuff Truck™ Convertible Hand Truck

Converts into a 4 wheeled platform. Tubular steel frame with welded joints. 14 x 7 in. toe plate. 8 in. rubber wheels with ball bearings. Continuous handle. 400 lb capacity (500 lb on 4 wheels). 18-1/2 x 12 x 52 in. H.  
**SAF 4070** (775528)

## D Tuff Truck™ Hand Truck

Tubular steel frame with welded joints. 14 x 7 in. toe plate. 8 in. rubber wheels with ball bearings. Continuous handle. 400 lb capacity. 19-1/2 x 14-1/2 x 45-1/2 in. H.  
**SAF 4069** (775049)

**E** SAFCO



**F** Rubbermaid Commercial Products



## E Hide-Away Hand Truck

Collapsible handle and fold-up toe plate allows for easy carrying and compact storage. 250 lb capacity. Lightweight aluminum frame. 6" rubber tires. 15-1/2 x 16-1/2 x 43-1/2"H (extended).  
**SAF 4061** (775056)

## F Triple Trolley Utility Cart

Non-skid, structural foam deck won't rust or dent. Three-position handle to pull, push or fold flat. Non-marking 5 in. casters. 32-1/2 x 20-1/2 in. 500 lb capacity. Black.  
**RUB 440100BLA** (196733)

## G Steel Platform Truck

Steel. Folding handlebar. Height: unfolded 33 in., folded 9 in. 600 lb capacity. 24 x 36 in.  
**SDU 9846** (697318)

## H Tuff Truck™ Platform Truck

Industrial strength and quality. Large platform with anti-skid mat. Folding handle for easy storage. Grey enamel finish.  
**400 lb capacity - 18-3/4 x 29 x 33-1/2 in. H.**  
**SAF 4072** (537340) 400 lb capacity.  
 18-3/4 x 29 x 33-1/2"H.  
**500 lb capacity - 24 x 36 x 34 in. H.**  
**SAF 4063** (291229)

**G**



**H** SAFCO



## I Mobile Utility Cart With Handle

2 shelves. Plastic. Rounded corners.  
**39 x 17.88 x 33.25 in**  
**RUB FG450088BL** (765008) black  
**RUB450088-BG** (766576) beige  
**44 x 25.25 x 39 in**  
**RUB452088-BLA** (766592) black  
**RUB 452088-BG** (766584) beige

**I**

Rubbermaid Commercial Products





# Tradition

Workers want traditional tools to share and preserve information and ideas. In this section you will find all the papers, notepads and notebooks that are still very much a part of office life.



# PAPER AND FILING

## PAPER

Copy and Print Paper .....	408
Notes and Cards .....	417
Specialty Paper .....	418
Wide Format Paper .....	420
Printer Rolls .....	421
Certificates .....	422

## NOTEBOOKS AND PADS

Notebooks and Pads .....	425
Loose-Leaf Paper .....	437
Message Books and Pads .....	438
Dated Planners and Calendars .....	440
Visitor Logbooks .....	442
Self-Adhesive Notes and Flags .....	444

## ACCOUNTING AND BUSINESS FORMS

Record Books and Pads .....	451
Payroll and Human Resources .....	452
Vehicle Logbooks .....	452
Invoices and Receipts .....	453
Service and Order Forms .....	454
Legal Supplies .....	455

## FILING AND LABELLING SUPPLIES

File Folders and Accessories .....	458
Hanging File Folders and Accessories .....	468
Labels .....	473
File Sorters/Organizers .....	480
Pockets and Expanding Files .....	481
Index Card Filing .....	489
Storage and Archive Boxes .....	491
File Totes and Carts .....	495





**A** BUSINESS SOURCE®



**A Business Source® Copy Paper**

For high-speed copiers and laser printers. Acide-free. 92 bright. 20 lb.  
**Box of 2,500 (5 packs of 500)**  
**BSN 32125** (1045328) 8-1/2 x 11 in.  
**BSN 36590** (1045203) 11 x 17 in.  
**Box of 5,000 (10 packs of 500)**  
**BSN 36591CT** (1045336) 8-1/2 x 11 in.  
**BSN 36592** (1045211) 8-1/2 x 11 in., 3-hole punched  
**BSN 36593** (1045229) 8-1/2 x 14 in.

**B Elite® Image Superior Multipurpose Paper**

For ink jet, laser printers, copiers and general use. Color Lok® technology. 98 bright. 20 lb.  
**Box of 2,500 (5 packs of 500)**  
**ELI 45000** (1045161) 8-1/2 x 11 in.  
**ELI 45013** (1045237) 11 x 17 in.  
**Box of 5,000 (10 packs of 500)**  
**ELI 45010** (1045344) 8-1/2 x 11 in.  
**ELI 45011** (1045310) 8-1/2 x 11 in., 3-hole punched  
**ELI 45012** (1069054) 8-1/2 x 14 in.



**B** Elite® Image



**C** Domtar



**C EarthChoice® Office Paper**

For ink jet, laser printers and copiers. 92 bright. 20 lb. FSC® certified.  
**Box of 2,500 (5 packs of 500)**  
**DMR 2703** (823793) 11 x 17 in.  
**Box of 5,000 (10 packs of 500)**  
**DMR 2700** (823672) 8-1/2 x 11 in.  
**DMR 2701** (823677) 8-1/2 x 11 in., 3-hole punched  
**DMR 2702** (823674) 8-1/2 x 14 in.

**D Lettermark™ Copy Paper**

92 bright. 20 lb. 40M. Package of 500. White. SFI certified.  
**20 lb**  
**DMR 3970** (823792) 8-1/2 x 11 in.  
**DMR 3971** (823814) 8-1/2 x 11 in., 3-hole punched  
**DMR 3973** (823673) 11 x 17 in.  
**24 lb**  
**DMR 3976** (823869) 8-1/2 x 11 in.



**D** Domtar



**E** Domtar



**E Load 'N Go® EarthChoice® Office Paper**

No ream wrap for reduced loading time. 25 lb carton for improved lifting and handling. For ink jet, laser printers and copiers. 92 bright. 20 lb. Letter size. Box of 2500. FSC® certified.  
**DMR 1970** (368985) 8-1/2 x 11

**F Paperline™ Office Paper**

For ink jet, laser printers and copiers. 92 bright. 20 lb.  
**Package of 500**  
**AIU 13044** (423491) 11 x 17 in.  
**Box of 5,000 (10 packs of 500)**  
**AIU 14009** (334755) 8-1/2 x 11 in.  
**AIU 13043** (334730) 8-1/2 x 14 in.



**F** PAPERLINE



**G** PAPERLINE



**G Hi-Grade Premium Multipurpose Paper**

For ink jet, laser printers and copiers. 20 lb. 98 bright. PEFC certified.  
**Box of 5000 (10 packs of 500)**  
**AIU 14001** (1076819) 8-1/2 x 11 in.  
**AIU 14002** (806372) 8-1/2 x 14 in.  
**Package of 500**  
**AIU 14003** (806380) 11 x 17 in.

## A Lettermark® Premium Paper

Professional quality. For ink jet, laser printers and copiers. 96 bright. Package of 500. SFI certified.

- 20 lb**  
DMR 3984 (817403) 8-1/2 x 11 in.
- DMR 3993 (823790) 11 x 17 in.
- 24 lb**  
DMR 3990 (817312) 8-1/2 x 11 in.



## B Pacesetter Paper

For ink jet and laser printer. 20 lb. 98 bright. Package of 500.

- SPL PACHB10FSC (569947) 8-1/2 x 11 in.
- SPL 548792 (548792) 8-1/2 x 14 in.
- SPL PACHB20FSC (542787) 11 x 17 in.



## C Multipurpose20 Paper

For inkjet printers, laser printers and copiers. 96 bright. 20 lb. Provides vivid colours and bolder blacks. Package of 500. FSC® certified.

- HEW 112000 (286591) 8-1/2 x 11 in.
- HEW 001420 (1045278) 8-1/2 x 14 in.
- HEW 172001 (1045260) 11 x 17 in.



## D Fore® Multipurpose Paper

For ink jet printers, laser printers and copiers. 96 bright. Acid-free. Jam-free. Package of 500. FSC® certified.

- 20 lb**  
HAM 10326-7 (776377) 8-1/2 x 11 in.
- HAM 10329-1 (776393) 8-1/2 x 14 in.
- HAM 10319-2 (776401) 11 x 17 in.
- 24 lb**  
HAM 10328-3 (776385) 8-1/2 x 11 in.
- HAM 101279 (515007) 8-1/2 x 14 in.
- HAM 102848 (515015) 11 x 17 in.



## E Tidal® Multipurpose Paper

For ink jet printers, laser printers and copiers. 92 bright with high opacity. 999 anti-jam. 20 lb. FSC® certified.

- Package of 500  
HAM 162008 (306480) 8-1/2 x 11 in.
- Box of 2,500 (5 packs of 500)  
HAM 16312-0 (306498) 8-1/2 x 11 in.



## F Copy Plus® Paper

For inkjet printers, laser printers and copiers. 92 bright with high opacity. 999 anti-jam. 20 lb. Package of 500. FSC® certified.

- HAM 10503-1 (1003789) 8-1/2 x 11 in., 3-hole punched
- HAM 105500 (804021) A4
- HAM 10501-5 (1003797) 8-1/2 x 14 in.
- HAM 10502-3 (1003805) 11 x 17 in.



## G Office20 Paper

Multipurpose paper for any printers and copiers. Ultra white shade provides higher print contrast for brighter sharper text and colours. Color Lok® technology. 92 bright. 20 lb. Paquet de 500. FSC® certified.

- HEW 112101 (1045451) 8-1/2 x 11 in.
- HEW 001422 (1045435) 8-1/2 x 14 in.
- HEW 172000 (1045427) 11 x 17 in.



## H Xerox Vitality™ Multipurpose Paper

For ink jet printers, laser printers and copiers. Precision cut edges produce 20% less paper dust. 20 lb. 92 bright. FSC® certified.

- Box of 5000 (10 packs of 500)  
XER 3R2047RM (161216) 8-1/2 x 11 in.
- Package of 500  
XER 3R2051 (538553) 8-1/2 x 14 in.
- Box of 2500  
XER 3R03761 (538595) 11 x 17 in.





**A** Domtar



**B** **ROLLAND**  
Rolland Enterprises Inc.



**A EarthChoice®  
Multipurpose Recycled Paper**  
20 lb. 92 brightness. Box of 5000 (10 packs of 500).  
30% recycled content. FSC® certified.  
**DMR 1842** (823675) 8-1/2 x 11 in.  
**DMR 3964** (823676) 8-1/2 x 14 in.

**B Enviro™ Copy Multipurpose Paper**  
For ink jet, laser printers and copiers. Treated 100% chlorine free.  
20 lb. 92 bright. Package of 500. 100% post-consumer recycled content. FSC® certified.  
**ROI 5101** (764829) 8-1/2 x 11 in.  
**ROI 5103** (776443) 8-1/2 x 14 in.  
**ROI 5104** (776435) 11 x 17 in.

**C Offix® 100 Recycled Paper**  
For fax machines, copiers, laser printer guaranteed. 20 lb. 92 bright. 100% post-consumer recycled content. FSC® certified.  
**Package of 500**  
**NVX 8041** (301903) 8-1/2 x 11 in.  
**NVX 8042** (301960) 8-1/2 x 11 in., 3-hole punched  
**NVX 8043** (301911) 8-1/2 x 14 in.  
**NVX 8044** (301929) 11 x 17 in.  
**Box of 2,500 (5 packs of 500)**  
**NVX 8049** (302216) 8-1/2 x 11 in.



**C** offix



**D** **ROLLAND**  
Rolland Enterprises Inc.

**D Hitech™ Multipurpose Paper**  
For ink jet and laser printers. 96 bright. Package of 500. 30% post-consumer recycled content. FSC® certified.  
**20 lb**  
**ROI 5466** (301895) 8-1/2 x 11 in.  
**24 lb**  
**ROI 5471** (128975) 8-1/2 x 11 in.

**E Sugar Sheet™ Copy Paper**  
Looks, performs, and recycles the same as regular paper. Made sugar cane by-product. Every 2 boxes saves 1 tree. Elemental Chlorine Free. 20 lb 92 bright. 8-1/2 x 11 in. Package of 500.  
**ISP 820** (584474)

**F Great White® 30 Recycled Copy Paper**  
92 bright. 20 lb. 8-1/2 x 11 in. Package of 500. 30% post-consumer recycled content. SFI certified.  
**HAM 86700** (306563)



**E**



**F** **HAMMERMILL**  
INTERNATIONAL PAPER



Find cover stock on page  
**pages 415-416**

## A Cougar® Digital Color Copy Paper

For digital printing. Super smooth printing surface with superior opacity. 98 bright. 28 lb. 10% post-consumer recycled content. FSC® and SFI certified.

**Package of 500**  
**DMR 2571** (162784) 8-1/2 x 11 in.  
**Box of 2000 (4 packs of 500)**  
**DMR 100702** (340927) 11 x 17 in.



## B Superior Performance Laser Paper

For laser printers and colour copiers. Acid-free. 96 bright. 24 lb. Letter size. Package of 500. 30% post-consumer recycled content. ELI 45002 (1045484)

## C Superior Performance Colour Copier Paper

For laser printers and colour copiers. Acid-free. 98 bright. 28 lb. Package of 500.  
**ELI 45003** (1045195) 8-1/2 x 11 in.  
**ELI 45004** (1045187) 11 x 17 in.



## D Bold™ Digital Printing Paper

Design to run in a variety of digital printers. 98 bright. Engineered and optimized for printing, giving you crisp text, vivid colors and outstanding images. Excellent reproduction of photographic details, subtle halftones and realistic skin tones. FSC® certified.

**Package of 500**  
**XER 3R13038** (560656) 8-1/2 x 11 in. (20 lb)  
**XER 3R11540** (577981) 8-1/2 x 11 in. (24 lb)  
**XER 3R11760** (792804) 8-1/2 x 11 in. (28 lb)  
**XER 3R11764** (577957) 8-1/2 x 11 in. (32 lb)  
**XER 3R11542** (577973) 8-1/2 x 14 in. (24 lb)  
**XER 3R11543** (577965) 11 x 17 in. (24 lb)  
**Box of 2000 (4 packages of 500)**  
**XER 3R11762** (538645) 11 x 17 in. (28 lb)



## E Premium Laser Print Paper

For laser printers and colour copiers. Perfect for high-resolution colour printing. 98 bright. Package of 500. FSC® certified.

**Package of 500**  
**HAM 10460-4** (720763) 8-1/2 x 11 in. (24 lb)  
**HAM 12553-4** (515023) 8-1/2 x 11 in. (28 lb)  
**HAM 104646** (515049) 8-1/2 x 11 in. (32 lb)  
**HAM 10461-2** (284877) 8-1/2 x 14 in. (24 lb)  
**HAM 10462-0** (347229) 11 x 17 in. (24 lb)  
**Box of 2500 (5 packs of 500)**  
**HAM 10464-0** (515031) 8-1/2 x 11 in. (24 lb)



## F Premium Color Copy Paper

For ink jet, laser printers and colour copiers. Jam-free. 100 bright. FSC® certified.

**Package of 500**  
**HAM 10246-7** (790253) 8-1/2 x 11 in. (28 lb)  
**HAM 10263-0** (306605) 8-1/2 x 11 in. (32 lb)  
**HAM 102475** (204230) 8-1/2 x 14 in. (28 lb)  
**HAM 10254-1** (204248) 11 x 17 in. (28 lb)  
**HAM 10266-0** (515072) 11 x 17 in. (32 lb)  
**HAM 106125** (515064) 12 x 18 in. (28 lb)  
**HAM 106127** (515080) 12 x 18 in. (32 lb)  
**Box of 2500 (5 packs of 500)**  
**HAM 10245-0** (515056) 8-1/2 x 11 in. (28 lb)



## G NCR Superior Carbonless Paper

Superior carbonless paper. Laser compatible. 8-1/2 x 11 in.

**3 copies. White/yellow/pink. 167 sets per package.**  
**SPL 423707** (423707)  
**4 copies. Goldenrod/pink/canary/white.**  
**125 sets per package.**  
**SPL SUP4PR107** (423715)





**A Premium24 Paper**

For laser printers. Heavy enough to print on both sides without show-through. 98 bright. 24 lb. 8-1/2 x 11 in. Package of 500. FSC® certified. HEW 115300 (349688)

**B Premium32 Paper**

Extra heavy weight paper gives your documents a professionally printed look and feel. Super smooth surface provides laser-sharp images. 98 bright. 32 lb. 8-1/2 x 11 in. Package of 500. FSC® certified. HEW 113100 (515148)

**C Bright White24 Paper**

For inkjet printers. Color Lok® technology. Ideal for presentations, flyers, newsletters and other bright colour-intensive documents. 100 bright. 24 lb. 8-1/2 x 11 in. Package of 500. FSC® certified. HEW 203000 (1045468)



**D Revolution™ Never Tear® Synthetic Paper**

Exceptional tear-proof paper. Holds up to wet weather, chemicals and rough handling. For laser printers only. 98 bright. 5 mil. 8-1/2 x 11 in. Package of 100. XER 3R20172 (1045666)

**E Granite Bond Paper**

For inkjet and laser printers. Ideal for résumés, reports and presentations. Acid and lignin-free. 24 lb. 8-1/2 x 11 in. 30% post-consumer recycled content. FSC® certified.

**Package of 100**

FST 78812 (287144) grey

FST 78813 (287151) ivory

FST 78814 (287169) white

**Package of 400**

FST 78302 (314898) grey

FST 78303 (314799) ivory



**F Résumé Bond Paper**

Linen finish. Flat printing surface for excellent reproduction in laser and inkjet printers. With water mark. 24 lb. 8-1/2 x 11 in. 30% post-consumer recycled content. FSC® certified.

**Package of 100**

FST 76600 (647784) white

FST 76602 (647792) ivory

**Package of 400**

FST 78155 (315176) white

FST 78156 (315184) ivory

**G Antique Bond Paper**

For inkjet and laser printers. 24 lb. Ideal for résumés, reports and presentations. Letter size. Acid and lignin-free. 24 lb. 8-1/2 x 11 in. 30% post-consumer recycled content. FSC® certified.

**Package of 100**

FST 78723 (323212) natural

FST 78722 (287094) grey

FST 78724 (323337) white

FST 78726 (695114) blue

FST 78728 (775726) aged

**Package of 400**

FST 78223 (652560) natural

FST 78226 (695106) blue

FST 78228 (775718) aged



## A Premium Color Copy Cover Paper

For ink jet, laser printers and colour copiers. 100 bright. Jam-free. Package of 250. White. FSC® certified.

- 60 lb**
- HAM 12254-9** (790170) 8-1/2 x 11 in.
- HAM 122556** (790220) 11 x 17 in.
- HAM 120040** (515098) 12 x 18 in.
- 80 lb**
- HAM 120023** (790188) 8-1/2 x 11 in.
- HAM 120037** (790212) 11 x 17 in.
- HAM 133200** (515106) 12 x 18 in.
- 100 lb**
- HAM 120024** (790162) 8-1/2 x 11 in.
- HAM 133202** (515114) 11 x 17 in.
- HAM 133201** (515122) 12 x 18 in.



## B Cougar® Digital Cover Stock

Perfect for digital printing. Smooth, uniform surface and bright white for dazzling results. 98 bright. 8-1/2 x 11 in. Package of 250. White. 10% post-consumer recycled content. FSC® certified and SFI.

- DMR 2985** (306613) 65 lb
- DMR 526311** (301861) 80 lb



**A**

INTERNATIONAL PAPER  
**HAMMERMILL**



**B**

**Domtar**



## C Springhill® Digital Cover Stock

For ink jet or laser printers and copiers. Smooth hard surface for brochures, covers and file cards. 92 bright. 8-1/2 x 11 in. Package of 250. White. SFI certified.

- SGH 15101** (306621) 90 lb
- SGH 15300** (306639) 110 lb



**C**

INTERNATIONAL PAPER



## D Exact Index White Cardstock

For laser or inkjet printers and copiers. Ideal for brochures, covers, tabs, file folders and business forms. 94 bright. 8-1/2 x 11 in. Package of 250. White. FSC® certified.

- NEE 80211** (599613) 67 lb
- NEE 40311** (599555) 90 lb
- NEE 40411** (599605) 110 lb

## E Hitech™ Cover Stock

For ink jet and laser printers. 96 bright. 60 lb. 8-1/2 x 14 in. Package of 500. 30% post-consumer recycled content. FSC® certified.

- ROI 1908** (348185)

## F Lettermark Bristol Multipurpose Cover Stock

For any type of printer or copier. 67 lb Vellum heavyweight paper. Package of 250. FSC® certified.

- DMR 82880** (790154) 8-1/2 x 11 in.
- DMR 142671** (349498) 8-1/2 x 14 in.



**D**

**N**  
NEENAH PAPER



**F**

**Domtar**



**E** **ROLLAND**  
Rolland Enterprises Inc.



**A Astrobrights® Coloured Cover Paper**

For laser or inkjet printing. Acid-free and lignin-free. 65 lb. 8-1/2 x 11 in. Package of 250. FSC® certified.

**NEE 22401** (599969) stardust  
**NEE 21021** (599878) lift-off lemon  
**NEE 21041** (599894) pulsar pink  
**NEE 21855** (599944) terrestrial teal  
**NEE 21869** (599951) vulcan green  
**NEE 22721** (599886) lunar blue  
**NEE 22731** (599928) solar yellow  
**NEE 22741** (599860) gamma green  
**NEE 22751** (599902) re-entry red  
**NEE 22781** (599936) terra green  
**NEE 22841** (599910) rocket red  
**NEE 22851** (599845) cosmic orange  
**NEE 22881** (599852) fireball fuchsia

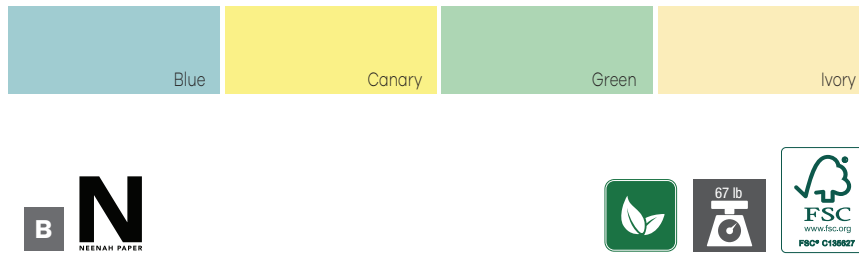

**B Exact Index Colour Cardstock**

For laser or inkjet printing. Acid-free and lignin-free. 65 lb. 8-1/2 x 11 in. Package of 250. FSC® certified.

**NEE 82321** (599621) blue  
**NEE 82331** (599639) yellow  
**NEE 82351** (599654) green  
**NEE 82361** (599662) ivory

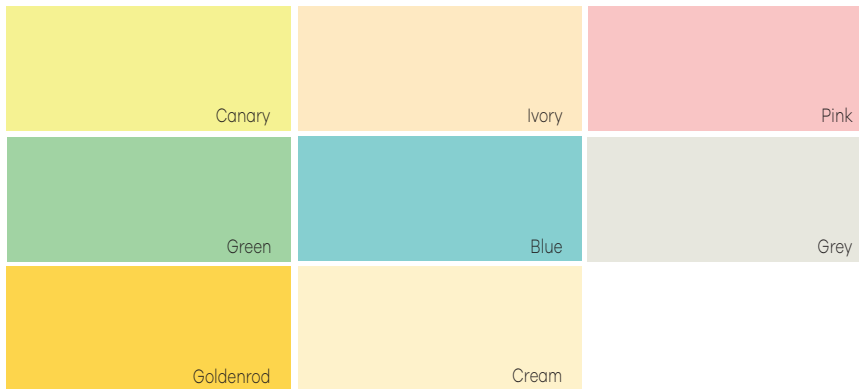

**C Lettermark Bristol Multipurpose Cover Stock**

For any type of printer or copier. 67 lb Vellum heavyweight paper. 8-1/2 x 11 in. Package of 250. FSC® certified.

**DMR 81044** (103697) canary  
**DMR 142656** (349514) ivory  
**DMR 142657** (349522) pink  
**DMR 81040** (798934) green  
**DMR 81042** (798967) blue  
**DMR 81043** (103713) grey  
**DMR 81057** (349597) goldenrod  
**DMR 81212** (103705) cream



**D Astrobrights® Colour Cardstock**

For laser or inkjet printers and copiers. Ideal for brochures, covers, tabs, file folders and business forms. 8-1/2 x 11 in. 65 lb. Package of 250. FSC® certified.

**NEE 21004** (600197) happy  
**NEE 21003** (600221) vintage  
**NEE 99904** (600213) bright



Happy Vintage Bright





**A Coloured Paper Astrobrights®**

For laser and inkjet printers. 24 lb. 8-1/2 x 11 in. Package of 500. FSC® certified.

- NEE21588 (599829) terra green
- NEE 21018 (599779) lift-off lemon
- NEE 21038 (599795) pulsar pink
- NEE 21528 (599787) lunar blue
- NEE 21538 (599811) solar yellow
- NEE 21548 (599761) gamma green
- NEE 21558 (599803) re-entry red
- NEE 21658 (599746) orange
- NEE 21688 (599753) fireball fuschia
- NEE 21849 (599720) terrestrial teal
- NEE 21859 (599738) vulcan green
- NEE 21946 (599696) outrageous orchid
- NEE 22301 (599837) stardust white
- NEE 22571 (599688) galaxy gold
- NEE 22641 (599712) rocket red
- NEE 22661 (599670) celestial blue
- NEE 22671 (599704) planetary purple



**B Lettermark®**

**Multipurpose Colour Paper**

For any type of printer or copier. 20 lb. Package of 500 sheets SFI certified. 30% post-consumer recycled content.

Letter size - 8-1/2 x 11 in.

- DMR 94284 (790402) blue
- DMR 94290 (790410) canary
- DMR 94296 (790428) cream
- DMR 94299 (790436) goldenrod
- DMR 94302 (790444) grey
- DMR 94304 (790451) green
- DMR 94308 (285049) ivory
- DMR 94311 (790469) orchid
- DMR 94314 (790477) pink
- DMR 94318 (790485) salmon

Legal size - 8-1/2 x 14 in.

- DMR 81091 (783647) blue
- DMR 81088 (783654) canary
- DMR 81089 (783696) green

Ledger size - 11 x 17 in.

- DMR 81010 (565887) green
- DMR 81012 (565879) blue
- DMR 81009 (102160) canary



**C Lettermark**

**Multipurpose Coloured Paper**

For any type of printer or copier. 24 lb. 8-1/2 x 11 in. Package of 500. 30% post-consumer recycled content. FSC® certified.

- DMR 81070 (319483) pink
- DMR 81071 (319517) blue
- DMR 81067 (319525) canary
- DMR 81073 (319509) goldenrod
- DMR 81066 (319491) green

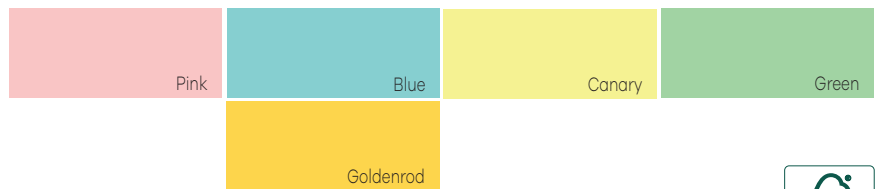

**D Pastel Colour Paper**

For laser and ink jet printers. 20 lb. Package of 500.

Letter size - 8-1/2 x 11 in.

- AIU 01301 (135889) ivory
  - AIU 01304 (136051) yellow
  - AIU 01307 (136069) pink
  - AIU 01309 (136077) blue
  - AIU 01311 (136085) green
  - AIU 01324 (136101) lavender
  - AIU IT200GOLD (136093) gold
- Legal size - 8-1/2 x 14 in.
- AIU 01601 (137356) ivory
  - AIU 01604 (137364) yellow
  - AIU 01607 (137372) pink
  - AIU 01609 (137380) blue
  - AIU 01611 (137398) green
  - AIU 137406 (137406) gold
  - AIU 01624 (137414) lavender





Cool

Neon

Vintage

Happy

Bright



**A Astrobrights® Coloured Paper**

For laser or inkjet printing. Letter size. Acid-free and lignin-free. 24 lb. 8-1/2 x 11 in. Package of 500. Assorted colours. FSC® certified.  
**NEE20274** (599977) cool  
**NEE20270** (600098) neon  
**NEE21224** (600106) vintage  
**NEE21289** (599985) happy  
**NEE99608** (599993) bright

**B Astrobrights® Coloured Paper**

For laser or inkjet printing. Acid-free and lignin-free. 24 lb. 8-1/2 x 11 in. Assorted colours (solar yellow, lunar blue, re-entry red, cosmic orange, terra green.) FSC® certified.  
**NEE 22998** (600403) box 1250  
**NEE 22999** (600411) box 2500



**C Deep Colour Paper**

For laser and ink jet printers. 20 lb. 8-1/2 x 11 in. Package of 500.  
**AIU IT210LEMON** (137265) lemon  
**AIU 01315** (137281) red  
**AIU 137273** (137273) saffron  
**AIU IT220** (137307) turquoise  
**AIU 137299** (137299) parrot



**D Cyber Colour Paper**

For laser and ink jet printers. 20 lb. Letter size. Package of 500.  
**AIU 01336** (137315) pink  
**AIU 01338** (137430) green  
**AIU 01340** (137349) red (fuschia)  
**AIU 01339** (137257) yellow



**E Astrobrights® Paper**

For laser and ink jet printing. Acid-free and lignin-free. 24 lb. 8-1/2 x 11 in. Package of 100. BRIGHT colours. FSC® certified.  
**NEE AB98768** (570382)

**F Fluorescent Bond Paper**

Multipurpose paper for all printers, copiers and fax machines. Acid-free. 24 lb. Letter size. 8-1/2 x 11 in. Package of 200. 50% 30% post-consumer recycled content. FSC® certified.  
**Fushia, teal, solar yellow, orange, purple**  
**FST 78020** (679381)  
**Pink, yellow, red, green, orange**  
**FST 78120** (286971)



**A Business Cards**

For laser printers. With ultra-fine perforations. 80 lb.  
**Package of 250**  
**AVE 5371** (279638) white  
**AVE 5376** (392019) ivory  
**Package of 2500**  
**AVE 5911** (392001) white



**B Business Cards**

For ink jet printers. With ultra-fine perforations. Package of 250.  
**AVE 8371** (392035) white (85 lb)  
**AVE 8376** (480806) ivory (80 lb)



**C Clean Edge Business Cards**

High quality heavyweight stock. A special coating on both sides offers to print on both sides. Snap apart for easy separation with clean, smooth edges. Package of 200.  
**For laser printer**  
**AVE 55871** (667527) white (81 lb)  
**For inkjet printer**  
**AVE 38871** (623603) white (94 lb)



**D Instant Business Card Magnet**

Peel and stick coating for your business card. Just peel and magnetize. Package of 25.  
**VLB 61225** (829719)



**E Tent Cards**

For ink jet and laser printers. White embossed cardboard. 65 lb.  
**2-1/2 x 8-1/2 in. - box of 100**  
**AVE 5305** (392191)  
**3-1/2 x 11 in. - box of 50**  
**AVE 5309** (392209)



**F Overtures® Place Card**

For ink jet and laser printers. Traditional emboss. Package of 60 place cards. 6 cards per sheet. 1-3/4 x 4-1/4 in. folded. 10% post-consumer recycled content. FSC® certified.  
**FST 71413** (562942) white  
**FST71414** (634550) ivory



**G Overtures® Note Cards**

For ink jet and laser printers. Traditional emboss. Package of 40 cards and envelopes. 2 cards per sheet. 5-1/2 x 4-1/4 in. folded. 10% post-consumer recycled content. FSC® certified.  
**FST 71020** (612200) white  
**FST 71021** (612218) ivory



**H Greeting Cards**

For ink jet printers. To create greeting cards with any creative software. Package of 20 white half-folded cards with envelopes. 85 lb.  
**5-1/2 x 8-1/2 in.**  
**AVE 03265** (460402)





**A Premium Plus Photo Paper**

Professional quality and durability for framing. Print smudge-free, water-resistant, instant-dry photos that last for years. 80 lb. Ink jet printing. FSC® certified.

**Glossy finish**

**HEW CR669A** (1045690) 5 x 7 in. (pkg 60)

**HEW CR670A** (326637) 8-1/2 x 11 in. (pkg 25)

**HEW CR664A** (543249) 8-1/2 x 11 in. (pkg 50)

**Soft gloss finish**

**HEW CR667A** (1045682) 8-1/2 x 11 in. (pkg 50)

**B Advanced Photo Paper Gloss Finish**

For ink jet printers. Instant drying. Glossy finish. 91 bright. 66 lb. FSC® certified.

**HEW Q6638A** (515155) 4 x 6 in. (pkg 100)

**HEW Q8690A** (162800) 5 x 7 in. (pkg 60)

**HEW Q7853A** (515163) 8-1/2 x 11 in. (pkg 50)

**C Everyday Glossy Photo Paper**

For ink jet printers. Glossy finish. 4 x 6 in. 53 lb. Package of 100. FSC® certified.

**HEW CR759A** (286609)



**D Ultra Premium Glossy Photo Paper**

Designed to let you create your own professional looking double sided brochures and flyers with impactful colours and text on both sides. 79 lb/11.8 mil. 8-1/2 x 11 in. Package of 50.

**EPS S042175** (326777)

**E Glossy Photo Paper**

For Inkjet printers. Perfect for reprints and everyday photos. Instant dry. 52 lb. 8-1/2 x 11 in. Package of 20.

**EPS S041141** (515171)

**F Photo Paper Plus Glossy II Photo Paper**

Glossy finish with exceptionally rich colours, giving your images the look and feel of a traditional photograph. 10.6 mil thickness. 70 lb. 92 bright. Package of 20.

**CNM PP3014X6** (515205) 4 x 6 in.

**CNM PP301LTR** (515213) 8-1/2 x 11 in.



**G Matte Photo Paper**

For ink jet printers. Matte finish. Borderless printing (compatible printer required). 108 bright. 8.5 mil. thickness.

**CNM MP1014X6** (515197) 4 x 6 in. (pkg 120)

**CNM MP101LTR** (720193) 8-1/2 x 11 in. (pkg 50)

**H Magnet Sheets**

Sticks to any magnetic surface. For ink jet printer. 8-1/2 x 11 in. Package of 5. White.

**AVE 03270** (404756)

**I Sticker Project Paper**

For ink jet printer. Removable and repositionable. 8-1/2 x 11 in. Package of 15. White.

**AVE 03383** (718510)



**A Brochure Paper**

For Inkjet printer. Produce image rich brochures and flyers. Print on both sides of the page, 48 lb. Package of 150.

- Glossy finish - 98 bright**
- HEW Q1987A** (1045567) 8-1/2 x 11 in.
- HEW C6932A** (423509) 11 x 17 in.
- Matte finish - 103 bright**
- HEW CH016A** (327007) 8-1/2 x 11 in.



**B Enhanced Trifold Business Paper**

For laser printer. Pre-scored for easy folding. Print on both sides of the page. Glossy, 97 bright. 40 lb. 8-1/2 x 11 in. Package of 150.

- HEW Q6612A** (1045518)

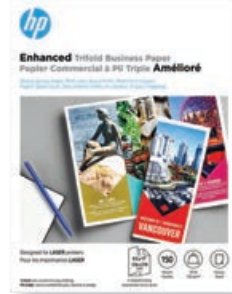

**C Professional Trifold Business Paper**

For inkjet printer. Pre-scored for easy folding. Print on both sides of the page. Glossy, 98 bright. 48 lb. 8-1/2 x 11 in. Package of 150.

- HEW 4WN12A** (1045526)



**D Professional Business Paper**

High-end, heavyweight, glossy paper. Ideal for flyers, brochures and marketing documents. Compatible with most laser printers. 97 bright. 52 lb. 8-1/2 x 11 in. Package of 150.

- HEW 4WN10A** (1045534)



**E Everyday Business Paper**

Print professional documents with print-shop quality. Compatible with laser printers. Glossy finish. 95 bright. 32 lb. Package of 150.

- HEW 4WN08A** (1045550) 8-1/2 x 11 in.
- HEW 4WN07A** (1045542) 11 x 17 in.

**F Photo Quality Paper**

For inkjet printers. Ultra smooth matte finish. 90 bright. 28 lb. 8-1/2 x 11 in. Package of 100.

- EPS S041062** (451500)

**G Matte Presentation Paper**

For inkjet printers. Non-glare finish. 44 lb. 8-1/2 x 11 in. Package of 50.

- EPS S041257** (515189)

**H High Quality Inkjet Paper**

Works with all inkjet printers. Bright non-glare finish. 24 lb. 8-1/2 x 11 in. Package of 100.

- EPS S041111** (1045674)

**I Stretchable Fabric Iron-On Transfers**

For stretchable cotton/poly blends and 100% polyester white fabrics. For ink jet printers. 8-1/2 x 11 in. Package of 5. White.

- AVE 03302** (112300)

**J Fabric Transfers**

Transfer sheets feed easily through most inkjet printers, and a new colour Shield formula ensures crisp, long-lasting image quality. To create reproductions on t-shirts or cotton/polyester with a household iron. 8-1/2 x 11 in.

- AVE 03275** (560813) light fabric (pkg 12)
- AVE 03279** (533976) dark fabric (pkg 5)





	Code	Reference	Size	Description	Weight	Parts	Specifications	Qty	Price
<b>Spicers® Continuous Form Paper</b>									
A	SPL 141007	829465	14-7/8 x 11"	Blank	20lb	1	N.V.P.	2700	
A	SPL 141107	829463	14-7/8 x 11"	1/2" Green Bar	20lb	1	N.V.P.	2700	
A	SPL 148107	829464	14-7/8 x 8-1/2"	1/2" Green Bar	20lb	1	N.V.P.	2700	
A	SPL 951028	829466	9-1/2 x 11"	Blank	18lb	1	1/2" L&R Perforations	3000	
A	SPL 951027	829467	9-1/2 x 11"	Blank	20lb	1	1/2" L&R Perforations	2700	
A	SPL 951522	829459	9-1/2 x 11"	Blank	15lb	2	1/2" L&R Perf./Carbonless	1700	
A	SPL 951523	829461	9-1/2 x 11"	Blank	15lb	3	1/2" L&R Perf./Carbonless	1200	
A	SPL 951322	829458	9-1/2 x 11"	White/Canary	15lb	2	1/2" L&R Perf./Carbonless	1700	
A	SPL 951323	829460	9-1/2 x 11"	White/Canary/Pink	15lb	3	1/2" L&R Perf./Carbonless	1200	
A	SPL 951324	829462	9-1/2 x 11"	White/Canary/Pink/Golden Rod	15lb	4	1/2" L&R Perf./Carbonless	900	

	Code	Reference	Description	Weight	Width	Length	Diameter	Qty	Price
<b>Premium Bond Plotting Paper</b>									
B	SLU 201901	385229	SelectSource Xerographic Bond	20lb	24"	150'	2"	4 rolls	
B	DTE CB0065	423194	dtec® Xerographic Bond	20lb	24"	150'	2"	Each	
B	SLU 201836	419713	SelectSource Xerographic Bond	20lb	24"	500'	3"	2 rolls	
B	DTE CB0066	548826	dtec® Xerographic Bond	20lb	24"	500'	3"	Each	
B	SLU 201824	385815	SelectSource Xerographic Bond	20lb	36"	150'	2"	4 rolls	
B	DTE CB0067	526277	dtec® Xerographic Bond	20lb	36"	150'	2"	Each	
B	SLU 201846	385757	SelectSource Xerographic Bond	20lb	36"	300'	2"	2 rolls	
B	SLU 201809	385765	SelectSource Xerographic Bond	20lb	36"	500'	3"	3 rolls	

<b>SelectSource Wide Format Coated Inkjet Paper</b>									
C	SLU 201819	385807	Water resistant	24lb	24"	150'	2"	Each	

<b>SelectSource Wide Format Inkjet Paper</b>									
D	SLU 201908	419424	Coated 2 sides	24lb	36"	150'	2"	4 rolls	

<b>HP Wide Format Paper</b>									
E	HEW C1860A	342303	Xerographic Bond	24lb	24"	150'	2"	Each	
E	HEW C1861A	423590	Xerographic Bond	24lb	36"	150'	2"	Each	
E	HEW C6810A	591107	Xerographic Bond	24lb	36"	300'	2"	Each	
E	HEW Q1404B	591230	Xerographic Bond	24lb	36"	300'	2"	Each	
E	HEW Q1396A	516096	Xerographic Bond	21lb	24"	150'	2"	Each	
E	HEW Q1397A	387993	Xerographic Bond	21lb	36"	150'	2"	Each	
E	HEW Q1398A	547695	Xerographic Bond	21lb	42"	150'	2"	Each	

<b>Iconex Wide Format Presentation Paper</b>									
F	ICX 9075-0206	828459	Bond Inkjet	20lb	24"	150'	2"	Each	
F	ICX 9075-0207	828460	Bond Inkjet	20lb	36"	150'	2"	Each	
F	ICX 9075-0208	828461	Bond Inkjet	20lb	42"	150'	2"	Each	

<b>dtec® Wide Format Paper Rolls</b>									
G	DTE 202130	1069095	Reprographic Bond Untaped	20lb	36"	500'	3"	Each	
G	DTE 202131	1048628	Reprographic Bond	20lb	36"	500'	3"	Each	
G	DTE 72240	1048636	Aqueous Coated Bond	24lb	24"	150'	2"	Each	
G	DTE 72243	1048644	Aqueous Matte finish	26lb	24"	150'	2"	Each	
G	DTE 72244	1048652	Aqueous Matte finish	26lb	24"	150'	2"	Each	

	Code	Reference	Description	Width	Length	Diameter	Qty	BPA Free	BPS Free	Price
<b>Calculator and Cash Register Paper Roll</b>										
A	CUS 66264-10	832960	Bond paper	1.73"	150'	2.55"-2.83"	Pkg 10			
A	CUS 65609	831181	Bond paper	3"	150'	2.64"-2.72"	Box 50			
A	CUS 65666	831180	Bond paper	2.25"	126'	2.14"-2.24"	Box 50			
A	BSN 28650	1048396	Bond paper	2.25"	150'	2.64"-2.72"	Pkg 12			
A	BSN 28625	1048388	Bond paper	2.25"	150'	2.64"-2.72"	Box 100			
A	CUS 65668	832874	Bond paper	2.25"	165'	2.33"-2.53"	Box 50			
A	CUS 65608	832877	Bond paper	3"	165'	2.33"-2.53"	Box 50			
A	BSN 31827	1048446	Bond paper	3"	165'	2.33"-2.53"	Pkg 12			
<b>Calculator and Cash Register Paper Roll</b>										
B	CUS 65801	832891	Carbonless paper. 2 part. white/yellow	2.25"	90'	3"	Box 50			
B	CUS 65802	832889	Carbonless paper. 2 part. white/yellow	3"	90'	2-5/8"	Box 50			
<b>Carbonless Paper Roll for Printing Calculators</b>										
C	CUS 62853	831176	Thermal Paper 2.1 mil / 48 g	2.25"	60'	1.58"	Box 50	X		
C	CUS 62855	831177	Thermal Paper 2.1 mil / 48 g	2.25"	75'	1.73"	Box 50	X		
C	ICX 90780076	1048553	Thermal Paper 2.1 mil / 48 g	2.25"	85'	1.81"	Pkg 3	X		
C	CUS 64758	832878	Thermal Paper 2.1 mil / 48 g	2.25"	150'	2.35"	Box 50	X		
C	ICX 90780079	1048578	Thermal Paper 2.1 mil / 48 g	2.25"	165'	2.43"	Pkg 3	X		
C	CUS 62840	832879	Thermal Paper 2.4 mil / 55 g	2.25"	30'	1.16"	Box 100	X		
C	CUS 64747	832882	Thermal Paper 2.1 mil / 48 g	2.25"	50'	1.55"	Box 50	X		
C	CUS 62854	831175	Thermal Paper 2.1 mil / 48 g	2.25"	60'	1.5"	Box 100	X		
C	CUS 62854-10	832888	Thermal Paper 2.1 mil / 48 g	2.25"	60'	1.62"	Pkg 10	X		
C	CUS 64785	831178	Thermal Paper 2.1 mil / 48 g	3"	215'	2.7"-2.85"	Box 50	X		
C	CUS 64774-3	832880	Thermal Paper 2.1 mil / 48 g	3.125"	225'	2.8"	Pkg 3	X		
C	CUS 64772	831179	Thermal Paper 2.1 mil / 48 g	3.125"	215'	2.7"	Box 50	X		
C	CUS 64770	832887	Thermal Paper 2.1 mil / 48 g	3.125"	200'	2.56"-2.65"	Box 50	X		
C	CUS 64740	832885	Thermal Paper 2.1 mil / 48 g	2.25"	85'	1.74-1.81"	Box 50	X	X	
C	CUS 64755	832883	Thermal Paper 2.1 mil / 48 g	3.125"	230'	2.64-2.87"	Box 50	X	X	
C	CUS 64777	832884	Thermal Paper 2.1 mil / 48 g	3.125"	273'	2.85-3.11"	Box 50	X	X	
C	CUS 62840-10	832881	Thermal Paper 2.1 mil / 48 g	2.25"	30'	1.5"	Pkg 10	X	X	

**D Cleaning Card**

For electric card reader. Package of 2.  
**CUS 66002** (832876)

**E Fax Rolls**

8-1/2" x 98' x 1/2" dia. Box of 6.  
**ICX 9073-0091** (243717)



**D**



**E** **ICONEX**





**A**

Self-adhesive gold seals included

**B**



**A Regent Certificates**

For ink jet and laser printers. Features a security imprint on reverse. Self-adhesive gold seals included. 24 lb. 8-1/2 x 11 in. Package of 25. 30% post-consumer recycled content. FSC® certified.

- Package of 25**
- FST83402** (652727) blue
- FST83409** (101519) red
- Package of 100**
- FST83500** (314906) blue
- FST83502** (1047968) red

**B Elite™ Linen Certificates**

For laser or inkjet printer. Premium linen. 24 lb. 11 x 8-1/2 po. Package of 12. 30% post-consumer recycled content. FSC® certified.

- FST83425** (315143) silver
- FST83429** (547497) gold

**C Gioche Certificates**

For ink jet and laser printers. Features a security imprint on reverse. Self-adhesive gold seals included. 24 lb. 8-1/2 x 11 in. Package of 25. 30% post-consumer recycled content. FSC® certified.

- FST 83404** (652735) red
- FST 83408** (652743) green

**D Gatsby Certificates**

Decorative foil on premium 65lb card stock. 8-1/2 x 11 in. Package of 15. 10% postconsumer recycled content. FSC® certified.

- FST83423** (562900) silver
- FST83407** (1047943) gold

**E Capital Certificates**

Decorative foil on premium 65lb card stock. 8-1/2 x 11 in. Package of 15. Gold. 30% postconsumer recycled content. FSC® certified.

- FST 83427** (652750)

**F Elite™ Classic Certificates**

For laser or inkjet printer. Premium linen. 24 lb. 11 x 8-1/2 po. Package of 12. 30% post-consumer recycled content. FSC® certified.

- FST 83428** (652768) pkg 12
- FST 83510** (789545) pkg 100

**G Regent Gift Certificates**

For laser or inkjet printer. Bond paper. 24 lb. 8-1/2 x 11 in. Package of 25 sheets (75 receipts). Blue. 30% postconsumer recycled content. FSC® certified.

- FST 83403** (652719)

Find seals on **page 455**

**C**



**D**



**E**



**F**



**G**





## A Presentation Cards

Simply insert the certificate and present. Non-folding style holder. Letter size. Package of 25. Certificate not included. 30% post-consumer recycled content. FSC® certified.  
**FST83482** (112169) burgundy  
**FST 83480** (112177) navy



## B Elite™ Medallion Double Fold Certificate Holders

Foil embossed medallion closure. Heavyweight linen, notched to accept letter-size documents. Package of 5. 30% post-consumer recycled content. FSC® certified.

### Copper medallion

**FST 83570** (112185) black

### Silver medallion

**FST 83536** (162982) navy

**FST 83566** (524611) black

### Gold medallion

**FST 83564** (789578) black

**FST 83534** (789560) blue

**FST 83533** (789552) burgundy

## C Certificate Holders

80 lb linen cover with classic design in gold foil. Notched to accept letter size documents. Package of 5. 30% post-consumer recycled content. Certified FSC®.

### With window

**FST 83538** (229682) navy

**FST 83539** (229690) black

### Without window

**FST 83434** (775742) navy

**FST 83464** (740704) black



## D Tuscan Certificate Frame

Molded plastic frame fits 8-1/2 x 11 in. documents. With gold trim. Protected by a scratch free plastic. Displayed on the wall in either portrait or landscape. Sold by each. 30% recycled content.

**FST 83902** (163048) black

**FST 83903** (163055) cherry

## E Milano Certificate Frame

Molded plastic frame fits 8-1/2 x 11 in. documents. Can be displayed on the wall or on a flat surface, in either portrait or landscape. Sold by each. Glossy black. 30% recycled content.

**FST 83904** (163063)

## F Milano Certificate Frame

Molded plastic frame and fits 8-1/2 x 11 in. documents. Can be displayed on the wall or on a flat surface, in either portrait or landscape. Sold by each. Cherry. 30% recycled content.

**FST 83912** (163097)

## G Certificate Frame

Molded plastic frame fits 8-1/2 x 11 in. documents. Displayed on the wall in either portrait or landscape. Sold by each. Black. 30% recycled content.

**FST 83914** (188854)

## H Tuxedo Certificate Frame

Double matted in white outer and black inner matting. Molded plastic frame fits 8-1/2 x 11 in. documents. Displayed on the wall in either portrait or landscape. Sold by each. Black. 30% recycled content.

**FST 83910** (280552)



 **Blueline®**

*FILOFAX®*

**Schneider**  Write it  
Made in Germany



 **Blueline®**



A CANADIAN COMPANY



**Your trusted brand for over 100 years**

**A Filofax® Floral Notebook**

Leather look cover with a unique flexibility. Twin-wire binding. Cover with integral reinforcement and can be folded open at a full 360. Elastic closure. 56 ruled sheets cream paper. Index, storage pocket and page-marker. Free refill, 4 quad sheets and 4 plain sheets. A5, 8-1/4 x 5-3/4 in. 30% post-consumer recycled paper.

- BLI B179518U (829333) blue
- BLI B179519U (829334) mint



**B Filofax® Classic Pastels Notebook**

Leather look cover with a unique flexibility. Twin-wire binding. Cover with integral reinforcement and can be folded open at a full 360. Pages can be easily added, removed or repositioned. 112 ruled sheets cream paper. Movable index, storage pocket and page-marker. A5, 8-1/4 x 5-3/4 in. 30% post-consumer recycled paper.

- BLI B115051U (573220) vista blue
- BLI B115052U (573253) green
- BLI B115053U (573212) pink
- BLI B115054U (573238) orchid
- BLI B115061U (573246) yellow



**C Filofax® Refillable Notebook**

Leather look cover with a unique flexibility. Twin-wire binding. Cover with integral reinforcement and can be folded open at a full 360. Elastic closure. 56 ruled sheets cream paper. Index, storage pocket and page-marker. Free refill, 4 quad sheets and 4 plain sheets. 30% post-consumer recycled paper.

- A5 - 8-1/4 x 5-3/4 in.
- BLI B115007U (342550) black
- BLI B115008U (342568) red
- BLI B115009U (342576) blue
- BLI B115010U (342584) orange
- BLI B115011U (342592) fuchsia
- BLI B115012U (342600) aqua
- Desk - 9-1/4 x 7-1/4 in.
- BLI B115901U (383471) black
- BLI B115902U (383489) red
- BLI B115903U (383497) blue
- BLI B115904U (383505) orange
- BLI B115905U (383513) fuschia
- BLI B115906U (383521) aqua
- Folio - 10-7/8 x 8-1/2 in.
- BLI B115101U (383356) black
- BLI B115102U (383364) red
- BLI B115103U (383414) blue
- BLI B115104U (383422) orange
- BLI B115105U (383430) fuschia
- BLI B115106U (383448) aqua

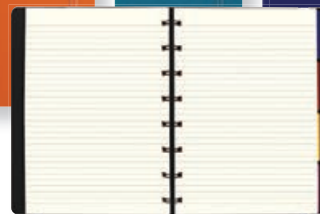
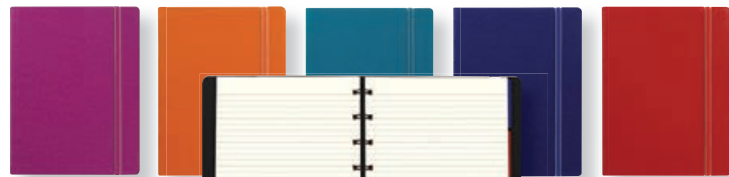

**D Filofax® Refill**

Cream paper. Package of 32. 30% post-consumer recycled content.

- A5 - 8-1/4 x 5-3/4 in.
- BLI B152451U (342675) plain
- BLI B152008U (342667) ruled
- BLI B152905U (342683) quadruled
- Desk - 9-1/4 x 7-1/4 in.
- BLI B192451U (383851) plain
- BLI B192008U (383836) ruled
- BLI B192905U (383869) quadruled
- Folio - 10-7/8 x 8-1/2 in.
- BLI B112451U (383331) plain
- BLI B112008U (383653) ruled
- BLI B112905U (383703) quadruled



**E MiracleBind™ Notebook**

Lizard-like hard cover. Twin wirebound. Self-adhesive tabs, index sheets and storage pocket. MiracleBind™ quadruled pages in bonus. High-quality ruled paper. 150 microperforated pages with margin (75 sheets). Pages can be removed and reinserted. 50% recycled content, 50% post-consumer. FSC® certified.

- 8 x 5 in.
- BLIAF615081 (1046515)
- 9-1/4 x 7-1/4 in.
- BLI AF915081 (133470) black
- BLI AF915083 (190108) red
- BLI AF915085 (270884) turquoise
- BLI AF915086 (190132) violet

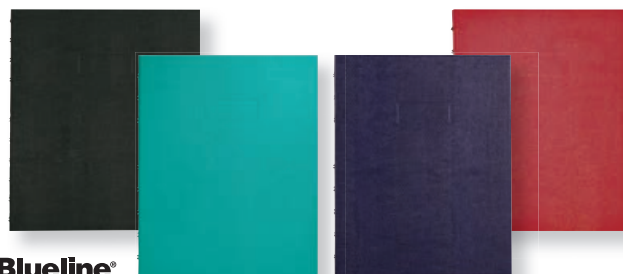

- 11 x 9-1/16 in.
- BLI AF115081 (133462) black
- Refill - package of 50.
- BLI AFR9050R (243600) 9-1/4 x 7-1/4 in.
- BLIAFR11050R (243592) 11 x 9-1/16 in.



**A**  **Blueline®**



**A NotePro™ Notebook**

Hard cover. Twin-wire binding. Self-adhesive tabs, index sheet and storage pocket. 192 microperforated pages (96 sheets), ruled with margin. Refillable with MiracleBind™ sheets. 9-1/4 x 7-1/4 in. 50% post-consumer recycled content. FSC® certified.

**BLI A9C-81** (655415) black

**BLI A9C-83** (655423) red

**BLI A9C-82** (655597) blue

**BLI A9C-84** (655605) green

**BLI A9C-46** (270876) purple

**B NotePro™ Notebook**

Hard cover. Twin-wire binding. Ruled with margin on the left side and quadruled on the right side. Self-adhesive tabs, index sheet and storage pocket. 192 microperforated pages (96 sheets), ruled with margin. Refillable with MiracleBind™ sheets. 9-1/4 x 7-1/4 in. Black. 50% post-consumer recycled content. FSC® certified.

**BLI A44C-81** (710640)

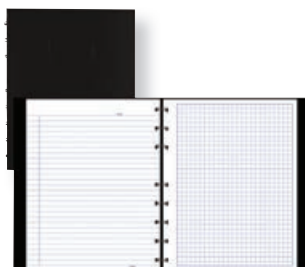

**B**  **Blueline®**

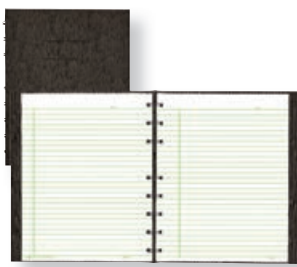

**C**  **Blueline®**



**C NotePro™ EcoLogix® Notebook**

Twin-wire binding with hard cover. 150 ruled microperforated pages (75 sheets) with margin. Refill with MiracleBind™ sheets. 9-1/4 x 7-1/4 in. Black. Post-consumer recycled content: 90% (binding), 100% (paper), 30% (cover). FSC® certified.

**BLI A7150EBLK** (112623)

**D NotePro™ Notebook**

Textured osterich hard cover. Twin-wire binding. Self-adhesive tabs, index sheet and storage pocket. 192 microperforated pages (96 sheets), ruled with margin. Refillable with MiracleBind™ sheets. 9-1/4 x 7-1/4 in. Black. 50% post-consumer recycled content. FSC® certified.

**BLI A8C81** (760199)



**D**  **Blueline®**



**E**  **Blueline®**



**E Notepro™ Notebook**

Hard cover. Twin-wire binding. Self-adhesive tabs, index sheet and storage pocket. 360 microperforated pages (180 sheets), ruled with margin. Refillable with MiracleBind™ refills. 9-1/4 x 7-1/4 in. Black. 50% post-consumer recycled content. FSC® certified.

**BLI A9CMAX-81** (239954)

**F Executive Journal**

Lizard-like hard cover. Glued binding. 150 pages ruled with margin. Ribbon bookmark. 10-3/4 x 8-1/2 in. 50% recycled content. FSC® certified.

**BLI A10-81** (239988) black

**BLI A10-82** (311522) blue



**F**  **Blueline®**



**G**  **Blueline®**



**G A7 Notebook**

Textured rigid cover with lizard finish. 150 pages (75 sheets) with margin. 9-1/4 x 7-1/4 in. 50% post-consumer recycled content. FSC® certified.

**BLI A7BLK** (481978) black

**BLIA7ASX** (562553) assorted colours

**H Ecologix Notebook**

Perfect binding hard cover. 150 ruled microperforated pages (75 sheets) with margin. Ecological tips at the end of the notebook. 9-1/4 x 7-1/4 in. Black. 90% recycled content (binding), 100% (paper), 50% (cover) post-consumer waste. FSC® certified.

**BLI A7EBLK** (239996)

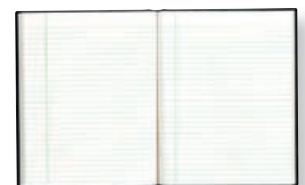

**H**  **Blueline®**



**I**  **Blueline®**

**I Notebook**

Hard cover. 144 pages (122 sheets), ruled with margin. 9-1/4 x 7-1/4 in. Black.

**BLI A80** (1046473)

**A Quartz Notebook**

Hard cover with twin-wire binding, 180 microperforated pages (90 sheets), ruled with margin, 9-1/4 x 7-1/4 in. Turquoise. 50% post-consumer recycled content. FSC® certified.  
**BLI A3890-01** (193078)

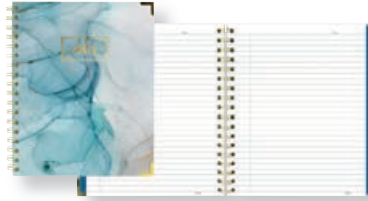

**B Pink Ribbon Notebook**

Hard cover. Twin-wire binding. Self-adhesive tabs, index sheet and storage pocket. 150 microperforated pages (75 sheets), ruled with margin. Refillable with MiracleBind™ sheets. 9-1/4 x 7-1/4 in. 50% post-consumer recycled content. FSC® certified.

- BLI A7150-PNK** (770834) pink
- BLI A7150BLK1** (790311) black
- BLI A7150PNK3** (222539) bright pink
- BLIA7150PNK5** (832633) daisy



**C NotePro Notebook**

Hard lizard-like cover. Twin-wire binding. Self-adhesive tabs, index sheet and storage pocket. Microperforated pages, ruled with margin. 10-3/4 x 8-1/2 in. 50% post-consumer recycled content. FSC® certified.

- 150 pages (75 sheets)**  
**BLIA10150-BLK** (101345) black
- 200 pages (100 sheets)**  
**BLI A10200-BLK** (665737) black
- BLI A10200-RED** (774588) red
- 300 pages (150 sheets)**  
**BLI A10300-BLK** (101352) black
- BLI A10300-RED** (283192) red

**A**  **Blueline®**



**B**  **Blueline®**



**D NotePro Black Notebook**

Hard cover. Twin-wire binding. Self-adhesive tabs, index sheet and storage pocket. 150 microperforated pages (75 sheets), ruled with margin. Refillable with MiracleBind™ sheets. 9-1/4 x 7-1/4 in. 50% post-consumer recycled content. FSC® certified.  
**BLI A7150-BLK** (774505)



**E Duraflex Notebook**

Textured poly cover. Twin-wire binding. 160 ruled pages (80 sheets), ruled with margin.

- BLI B4081** (1046557) 9-1/8 x 5-7/8 in. (black)
- BLIB4181** (534065) 11 x 8-1/2 in. (blue)

**C**  **Blueline®**



**D**  **Blueline®**



**F NotePro EcoLogix Notebook**

Twin-wire binding with hard cover. 150 ruled microperforated pages (75 sheets) with margin. 10-3/4 x 8-1/2 in. Black. Post-consumer recycled content: 90% (binding), 100% (paper), 30% (cover). FSC® certified.

- BLI A10200EBLK** (239913)



**G A9 Notebook**

Hard cover. Self-adhesive tabs and index sheet. 192 pages (96 sheets). 9-1/4 x 7-1/4 in. 50% post-consumer recycled content. FSC® certified.

- BLI A9** (17830) black
- BLI A9-59** (263293) red
- BLI A9-82** (263301) blue
- BLI A9-84** (263319) green
- Quadruled**  
**BLIA9Q** (286922) black

**E**  **Blueline®**

**F**  **Blueline®**



**H Notebook**

Hard cover. 192 pages (96 sheets), ruled with margin. 9-1/4 x 7-1/4 in. Black.  
**BLI A19-81** (529271)



**G**  **Blueline®**



**H**  **Blueline®**



**A** CAMBRIDGE®



**B** AMPAD™

**A Notebook**

Durable linen hardcover with gold foil design. Twin wire gold binding. 300 ruled pages (150 sheets). 8-1/2 x 6-1/2 in. Blue. **HLR 590155** (831341)

**B Versa Notebook**

Polypropylene cover. 8-ring binding. 120 ruled pages (60 sheets). Repositionable sheets and accessories. 105 self-adhesive flags and 30 - 3 x 3 in. adhesive notes, three dividers and two poly pockets. Refill is not available. Navy. **AMP 25-635** (214247) 6 x 9 in. **AMP 25-634** (226134) 11 x 8 in.

**C FocusNotes Notebook**

Sewn bound binding. Perfect for use at meetings, lectures and more. 160 pages (80 sheets). 7-1/2 x 9-3/4 in. Black. **OXF 90224** (1046820)

**D FocusNotes Notebook**

Spiral bound. Perfect for meetings, lectures and more. 200 microperforated pages (100 sheets). 9 x 11 in. Blue. **OXF 90223** (1046838)



**C** Oxford™



**D** Oxford™

**E Stone Paper Notebook**

Made from stone. Velvety texture. 120 ruled pages (60 sheets). Assorted colours. **OXF 161640E** (429308) 8-1/2 x 5-1/2 in. **OXF 161643E** (429316) 8-1/2 x 11 in.

**F Notebook**

Hard cover with twin wire binding. Interior pocket. Ruled pages with margin. Black. **192 pages (96 sheets)** **WNN W2-97BK** (1046549) 9 x 7-1/4 in. **152 pages (76 sheets)** **WNN W2-118BK** (1046531) 11 x 8-1/2 in.



**E** Oxford™



**F** Winnable

**G Notebook**

Flexible cover. 200 pages (100 sheets), ruled with margin. 7-1/2 x 9-3/4 in. Black. **HLR 09924** (101840)

**H Nature Saver Notebook**

Hard cover with spiral binding. 160 ruled pages (80 sheets). 8-1/4 x 5-7/8 in. Kraft. 100% post-consumer recycled content. **NAT 20205** (1046648)

**I Rediform Notebooks**

Flexible covers in bright colours. 64 ruled pages (32 sheets). 5-3/4 x 8-1/4 in. Package of 5. Assorted colours. **BLI A85** (1046804)



**G** Hilroy



**H** naturesaver®



**I** Blueline®

## A Core Smart Notebook

Provides a classic pen and paper experience. Feels like a traditional notebook. Endlessly reusable and connected cloud services. Ruled pages. Erasable with a moistened cloth. Includes 1 Pilot FriXion pen and 1 microfibre cloth. 36 pages. 8.8 x 6 in. Black.

**8.8 x 6 in. - 36 pages**  
**RKB 828885** (828885) black  
**RKB 832395** (832395) blue  
**11 x 8-1/2 in. - 32 pages**  
**RKB EVR2LRCAFR** (832393) black  
**RKB 832394** (832394) red



**A** **ROCKETBOOK**



**B** **ROCKETBOOK**



## B Fusion Smart Notebook

Provides a classic pen and paper experience. Feels like a traditional notebook. Endlessly reusable and connected cloud services. 42 reusable pages with 7 different page styles for planning, listing, goal setting, note-taking, sketching, and more. Erasable with a moistened cloth. Includes 1 Pilot FriXion pen and 1 microfibre cloth.

**8.8 x 6 in.**  
**RKB 828886** (828886) black  
**RKB 832398** (832398) turquoise  
**11 x 8-1/2 in.**  
**RKB EVRFLRCAFR** (832397) black  
**RKB 828887** (828887) grey



**C** **CAMBRIDGE®**



**D** **CAMBRIDGE®**



## C Tech Bungee Notebook

Hardbound cover. Tested rubber grips for security. Holds phone and up to 3 pens in place with secure bungee loops on front. 160 ruled pages (80 sheets) with date box on pages. 11 x 7-11/16 in. Black.

**HLR 59094** (366260)

## D Business Notebook

Hard Cover. Date box on every page and ribbon page marker. Index page with sticker tabs. 160 pages (80 sheets), ruled with margin. 9-1/2 x 7-1/4 in. Black. 30% post-consumer recycled content.

**HLR 6750** (318717)



**E** **CAMBRIDGE®**



**F** **CAMBRIDGE®**

## E Cambridge® City™ Business Notebook

Vinyl with PVC trim on front cover. Back rigid polypropylene cover. Sewn pocket on the inside of notebook. Twin-wire binding. Business card holder. 200 ruled pages (100 sheets). 11 x 7-7/8 in. Black.

**HLR 06083** (739995)

## F Cambridge® City™ Notebook

Polypropylene cover. Twin-wire binding. Ruled. Perforated pages 140 pages (70 sheets). Black.

**HLR 06016** (234120) 9-1/2 x 6-1/2 in.  
**HLR06018** (318329) 11-1/2 x 8-1/2 in.



**G** **CAMBRIDGE®**



**H** **CAMBRIDGE®**



## G Cambridge® Archiving Notebook

Hard cover. Twin wirebound. Black flap for easy storage. Magnetic closure. Includes pen loop storage, poly pocket with business card holder. Self-adhesive tabs. 200 microperforated ruled pages (100 sheets). 9-1/2 x 6-5/8 in. Metallic grey or blue.

**HLR 06248** (760256)

## H Cambridge® Notebook

Flexible soft-touch front and back cover. Twin wire binding. College black ruling with margin on white paper. 160 microperforated pages (80 sheets). Black. 30% post-consumer recycled content.

**HLR 06672** (740290) 9-1/2 x 6-5/8 in.  
**HLR 06062** (739979) 11 x 8-1/4 in.



**I** **CAMBRIDGE®**

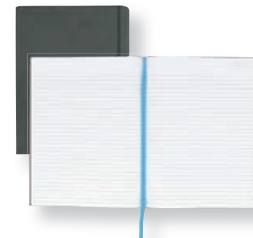

**J** **CAMBRIDGE®**

## I Notebook

Hardbound cover, twin wire binding and perforated premium heavyweight sheets. Includes smoky transparent twin poly pocket for storage. 160 ruled pages (80 sheets). 30% post-consumer recycled content.

**HLR 59214** (1046689) 9 x 7-1/4 in.  
**HLR 59216** (1046671) 11 x 8-3/8 in.

## J Notebook

Leatherette hard cover. Date box. Ribbon marker. Ruled. Black.

**HLR 59000** (1046663)

## K Cambridge® Notebook

160 wide-ruled pages (80 sheets). Spiral bound. Stiff back for easier writing. 9-1/2 x 7-1/4 in.

**HLR 06364** (101816)

**K** **CAMBRIDGE®**





**A** FIVE STAR  
★★★★★



**B** FIVE STAR  
★★★★★

**A Five Star® Notebook**

Water-resistant plastic front cover and heavy-duty cardboard back cover. Gold coil binding. 2-Pocket page dividers. 1 Subject. 200 ruled pages (100 sheets). 11 x 8-1/2 in. Assorted colours and patterns.  
**HLR 820048-22** (828303)

**B Five Star® Spiral Notebook**

1 subject. Polypropylene cover. Perforated pages. Storage pockets. 200 pages (100 sheets). 11 x 8-1/2 in. Assorted colours.  
**HLR 06040** (481937) ruled  
**HLR 06038** (481945) quadruled

**C Five Star® Spiral Notebook**

2 subjects. Polypropylene cover. Perforated pages. Storage pockets. 200 ruled pages (100 sheets). 9-1/2 x 6 in. Assorted colours.  
**HLR 06030** (481960)

**D Five Star® Spiral Notebook**

3 subjects. Polypropylene cover. Perforated pages. Storage pockets. 300 ruled pages (150 sheets). 11 x 8-1/2 in. Assorted colours.  
**HLR 06048** (698688)

**E Five Star® Spiral Notebook**

5 subjects. Polypropylene cover. Perforated pages. Storage pockets. Ruled pages. Assorted colours.  
**360 pages 180 sheets**  
**HLR 06034** (481952) 9-1/2 x 6 in.  
**400 pages (200 sheets)**  
**HLR 06046** (747568) 8-1/2 x 11 in.

**F Five Star® Clearview Notebook**

1 subject. Durable, clearview poly cover for customization and sturdy kraft back cover. 2-pocket dividers Perforated pages. 200 ruled pages (100 sheets). 11 x 8-1/2 in. Assorted colours.  
**HLR 08238** (181743)

**G Hilroy Notebook**

Polypropylene cover. Geometric square pattern. Spiral binding. 200 ruled pages (100 sheets). 10 1/2 x 8 in. Assorted colours.  
**HLR 66182** (181859)

**H Notebook**

Space on cover for name, subject and more. Index page. 2 fasteners. Included tab dividers and reminder stickers. Title and date box on pages. 200 ruled pages (100 sheets). 11 x 8-1/2 in. Assorted colours.  
**HLR 13048** (1046739)

**I Project Book**

Wide ruled. 40 pages (20 sheets). 10-7/8 x 8-3/8 in. Assorted colours.  
**HLR 12012** (534081)



**C** FIVE STAR  
★★★★★



**D** FIVE STAR  
★★★★★



**E** FIVE STAR  
★★★★★



**F** FIVE STAR  
★★★★★



**G** Hilroy



**H** Hilroy



**I** Hilroy



**A Spiral Notebook**

1 subject. 3-hole punched. Ruled pages. 10-1/2 x 8 in.  
Assorted colours. SFI certified.  
HLR 13121 (222851) 80 pages (40 sheets)  
HLR13129 (318006) 100 pages (50 sheets)  
HLR 05553 (732784) 140 pages (70 sheets)  
HLR13224 (257238) 200 pages (100 sheets)  
HLR 13223 (222869) 250 pages (125 sheets)



**A** *Hilroy*



**B Spiral Notebook**

1 subject. Ruled pages. 9-1/2 x 6 in. SFI Certified.  
Assorted colours.  
HLR 13401 (516195) 100 pages (50 sheets)  
HLR 13400 (32151) 200 pages (100 sheets)



**B** *Hilroy*



**C Spiral Notebook**

3 subjects. 3-hole punched. Ruled pages. 10-1/2 x 8 in.  
Assorted colours. SFI certified.  
HLR 13111 (257220) 108 pages (54 sheets)  
HLR 13225 (32169) 300 pages (150 sheets)  
HLR 05783 (595397) 240 pages (120 sheets)



**C** *Hilroy*

**D Spiral Notebook**

3 subjects. 300 ruled pages (150 sheets). 9-1/2 x 6 in. SFI Certified.  
Assorted colours.  
HLR 06909 (538447)



**D** *Hilroy*

**E Spiral Notebook**

5 subjects. Ruled pages. SFI Certified. Assorted colours.  
9-1/2 x 6 in.  
HLR 53140 (680157) 350 pages (175 sheets)  
10-1/2 x 8 in.  
HLR05693 (442640) 360 pages (180 sheets)

**F Recycled Notebook**

1 subject. 3-hole punched. Ruled pages. Assorted colours.  
100% recycled content, 30% post-consumer waste. SFI certified.  
9-1/2 x 6 in.  
HLR 13042 (112771) 160 pages (80 sheets)  
10-1/2 x 8 in.  
HLR 13040 (112763) 90 pages (45 sheets)



**E** *Hilroy*



**G Quadruled Notebook**

1 subject. 3-hole punched. Quadruled pages. 10-1/2 x 8 in.  
Assorted colours. SFI certified. 80 pages. 8 x 10.5 in.  
4 squares/inch  
HLR 13222 (257261) 80 pages (40 sheets)  
HLR 13009 (617977) 200 pages (100 sheets)  
Metric 5 mm  
HLR 13005 (275503) 80 pages (40 sheets)  
Metric 1 cm  
HLR 66368 (800581) 80 pages (40 sheets)



**F** *Hilroy*



**H Neatbook® Subject Notebook**

Perforated edges, 7 mm ruled with margin, white paper, 3 hole punched.  
Gloss card stock cover with secure sewn binding and black tape spine.  
10-1/2 x 8 in. Assorted colours.  
1 subject  
HLR 05304 (531442) 120 pages (sheets)  
HLR 05627 (529289) 160 pages (80 sheets)  
3 subjects  
HLR05265 (597575) 264 pages (132 sheets)



**G** *Hilroy*



**H** *Hilroy*



**A**  LOUIS GARNEAU



**B**  LOUISGARNEAU

**A Writing Book**

Laminated cover and thick paper. Interlined-dotted ruling.  
32 pages (16 sheets). 9 x 7 in. Assorted colours.  
**GCILG10** (107003) LG10 writing  
**GCILG20** (106997) LG20 writing  
**GCILG25** (132118) LG25 writing  
**GCILG30** (747220) LG30 projects  
**GCILG40** (781898) LG40 metric writing

**B Canada Notebook**

Laminated cover and thick paper. 3-hole punched.  
11 x 8 in. Assorted colours.  
**40 pages (20 sheets)**  
**GCI 40412315** (681189) ruled  
**GCI 40412325** (681197) metric quad  
**80 ruled pages (40 sheets)**  
**GCI 412380** (132126) ruled

**C Exercise Book**

80 ruled pages (40 sheets). 3-hole punched. 10-7/8 x 8-3/8 in.  
Package of 3. Assorted colours.  
**HLR 12107** (473462)

**D Steno Pad**

White, ruled paper. Open end. 6 x 9 in.  
**Without center line**  
**HLR53110** (17863) 120 pages  
**With center line**  
**HLR 53135** (380626) 350 pages

**E Steno Book**

Centre line. 6 x 9 in. 160 pages. Package of 12. Assorted colours.  
**HLR 43083** (283143)

**F Steno Pad**

360 ruled pages. Spiral bound with flexible cover.  
**Side binding**  
**BLIAT35B** (706853) 9 x 6 in.  
**End binding. Center line.**  
**BLI AT12B** (239970) 6 x 9 in.

**G Steno Pad**

Superior quality bond paper, stiff back. 20 lb. 8 x 5 in.  
Ruled Spiral 160 white pages (80 sheets).  
**HLR 06378** (680140)

**H Steno Notebook**

Wire bound. Ruled. 6 x 9 in. 140 yellow pages (70 sheets).  
**BSN 26741** (1046374)



**C** 



**D** 



**E** 



**F**  **Blueline**



**G**  **CAMBRIDGE**



**H**  **BUSINESS SOURCE**

**A Canada Exercise Book**

Quadruled 4 squares/inch. 3 perforations. 40 pages (20 sheets).  
10-7/8 x 8-3/8 in. Assorted colours.  
HLR12984 (275495)

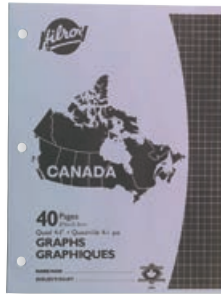

**B Canada Exercise Book**

Ruled pages. 3 perforations. 32 pages (16 sheets).  
10-7/8 x 8-3/8 in. Package of 4. Assorted colours.  
HLR 12692 (546457)

**C Quebec Writing Book**

Interlined dotted lines. 3 perforations. 28 pages (14 sheets).  
9 x 7 in. Assorted colours.  
HLR 12182 (275461)

**D Exercise Book**

1 subject. 3-hole punched. 140 ruled pages (70 sheets).  
10-1/2 x 8 in. Assorted colours.  
SPR 83253 (1046283) narrow ruled  
SPR 83250 (1046275) wide ruled

**E Exercise Book**

3 subjects. 3-hole punched. 240 ruled pages (120 sheets).  
10-1/2 x 8 in. Assorted colours.  
SPR83254 (1046291) narrow ruled  
SPR 83251 (1046317) wide ruled

**F Exercise Book**

5 subjects. 3-hole punched. 360 ruled pages (180 sheets).  
10-1/2 x 8 in. Assorted colours.  
SPR83255 (1046309) narrow ruled  
SPR 83252 (1046325) wide ruled

**G Lab Notebook**

Hard cover. Identification label. 200 pages (100 sheets)  
ruled with margin. 10 x 8-1/2 in. Blue. FSC® certified.  
BLI A91 (677443)

**H Composition Book**

160 ruled pages (80 sheets). 4-1/4 x 3-1/4 in. Package of 4.  
Assorted colours.  
SPR 36126 (1046432)

**I Composition Notebook**

160 ruled pages (80 sheets). 7-1/2 x 10 in. Black and white.  
100% post-consumer recycled content.  
SPR 65277 (1046705)





**A** CAMBRIDGE®



**B** CAMBRIDGE®

**A Cambridge® Commercial Memo Notebook**

Mock-leather hard cover. Ruled. Inside expanding storage pocket. Bungee elastic closure. Page marker. Cream paper. 192 ruled pages (96 sheets). Black.  
**HLR 43030** (1046408) 4 x 2-5/8 in.  
**HLR 43026** (164517) 5-9/16 x 3-9/16 in.

**B Cambridge® Personal Notebook**

Premium paper. Polypropylene cover. Spiral binding. 280 ruled microperforated pages (140 sheets). 7 x 4-3/8 in. Black.  
**HLR 45470** (232157)



**C** FIVE STAR  
★★★★★



**D** Blueline®



**C Five Star® Memo Book**

Polypropylene cover. Perforated pages. 400 ruled, micro perforated pages (200 sheets). 5-1/2 x 4-1/8. Assorted colours.  
**HLR 45388** (653311)

**D EcoLogix Memo Book**

Flexible Romanel cover. Glued binding. 100 ruled pages (50 sheets). Black. 50% recycled content (cover), 100% post-consumer waste (paper). FSC® certified.  
**BLI A385** (239905) 6-3/4 x 4 in.  
**BLI A435** (215632) 3-5/8 x 6 in

**E Memo Notebook**

Flexible cover. Sewn binding. Ruled pages. Black.  
**6-3/4 x 4 in - 96 pages (48 feuilles)**  
**WNN W185-BK** (528604)  
**7-1/2 x 4-3/5 in - 192 pages (96 sheets)**  
**WNN W165-BK** (558866)



**E** Winnable



**F** Mead

**F Notebook**

Sewn binding. 112 ruled pages (56 sheets). 5 x 3 in. Assorted colours.  
**HLR 42370** (473504)

**G Notebook**

Spiral binding. Assorted colours.  
**Open side - 120 pages (60 sheets)**  
**MEA45534** (481432) 5 x 3 in.  
**Open end - 120 pages (60 sheets)**  
**MEA45354** (481424) 3 x 5 in.  
**Open end - 80 pages (40 sheets)**  
**MEA45464** (656777) 4 x 6 in.

**H Poly Memo Book**

Spiral binding. Assorted colours.  
**3 x 5 in.**  
**MEA 45602** (101857) 200 pages (100 sheets)  
**4 x 6 in.**  
**MEA 45630** (101808) 150 pages (75 sheets)



**G** Mead



**H** Mead

**I Reporter Notepad**

Spiral binding with flexible cover. 160 ruled pages (80 sheets). 4 x 8 in. Blue.  
**BLI AT8B** (595991)

**J Designer Steno Book**

White paper with centre line. 160 pages (80 sheets). 6 x 9 in. Package of 6. Assorted black and white designs.  
**TOP 80230** (432385)



**I** Blueline®



**J** TOPS PRODUCTS



**K** CAMBRIDGE®

**K Cambridge Limited Office Pad**

Ruled 5/16". With margin. 50 sheets. 5 x 8 in. Package of 3. White.  
**HLR 66370** (774570)

**A FocusNotes™ Writing Pad**

Each sheet features a cue column, notes and summary section. Bilingual. 50 perforated sheets. 8-1/2 x 11-3/4 in. **TOP E77105** (534115)



**A** **Oxford™**

**B Cambridge® Office Pad**

Spiral bound. Stiff backing. 70 ruled white sheets. 8-1/2 x 11 in. **HLR 59898** (481150)



**B** **CAMBRIDGE®**

**C Cambridge® Office Pad**

Superior quality bond paper, stiff back. 20 lb. 8-1/2 x 11-3/4 in. **Ruled 5/16 in. (70 sheets)**  
**HLR59854** (232165) white  
**HLR59856** (407767) ivory  
**Ruled 5/16 in. and 3-hole punched (70 sheets)**  
**HLR 59864** (407734) white  
**Quadruled 4 sq./in. (80 sheets)**  
**HLR 59900** (407742) white



**C** **CAMBRIDGE®**

**D Prism+™ Coloured Paper Pad**

Cardboard backing. 50 ruled sheets. Package of 6. Assorted colours. **TOP 63016** (595744) 5 x 8 in.  
**TOP 63116** (595751) 8-1/2 x 11-3/4 in.



**D** **TOPS PRODUCTS**

**E Cambridge® Office Pad**

Ruled 5/16". With margin. 50 sheets. 8-1/2 x 11-3/4 in. Package of 3. **HLR59804** (740001) ivory  
**HLR 59806** (740019) blue  
**HLR 59810** (740035) orchid



**E** **CAMBRIDGE®**

**F Docket™ Three-Hole Punched Ruled Pad**

Heavyweight paper. 50 ruled sheets. 3-hole punched. 8-1/2 x 11-1/4 in. Package of 3. Yellow. **TOP 63392** (595892)

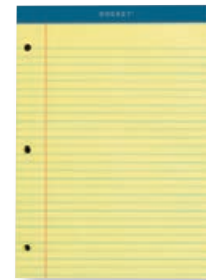

**F** **TOPS PRODUCTS**

**G Perf-Perfect® Figuring Pad**

50 sheets. Ruled 8 mm. 8-1/2 x 11-3/4 in. Canary yellow. Package of 10. **5 x 8-3/4 in. - sold by each (white)**  
**HLR54236** (192435) ruled 8/32  
**8-1/2 x 11-3/4 in. - sold by each (white)**  
**HLR 54130** (192419) ruled 11/32  
**HLR 54132** (192427) quadruled 4 sq./in.  
**8-1/2 x 11-3/4 in. - package of 10 (yellow)**  
**HLR 54131** (529297) ruled 11/32

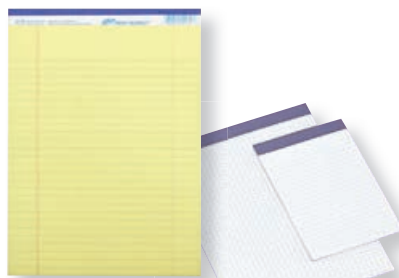

**G** **Hilroy**

**H White Perforated Paper Pad**

50 microperforated sheets. 3-hole punched. 20 lb. 8-1/2 x 11-3/4 in. **TOP20-366** (516203) narrow ruled  
**TOP 20-368** (516229) wide ruled  
**TOP 20-367** (516211) quadruled 4 sq.in.



**H** **AMPAD™**

**I Gold Fibre™ Office Pad**

Extra smooth and heavyweight paper. Ruled 9/32 in. with margin. 70 sheets. 3-hole punched. 8-1/2 x 11-3/4 in. **TOP 20-830** (543447)



**I** **AMPAD™**

**J Writing Pad**

50 detachable ruled sheets. Ruled 1/4 in. Package of 12. **5 x 8 in.**  
**BSN 63110** (1046085) white  
**BSN 63107** (1046077) yellow  
**8-1/2 x 11-3/4 in.**  
**BSN 63108** (1046127) white  
**BSN 63105** (1046119) yellow  
**8-1/2 x 14-3/4 in.**  
**BSN 63109** (1046101) white  
**BSN 63106** (1046093) yellow



**J** **B BUSINESS SOURCE®**

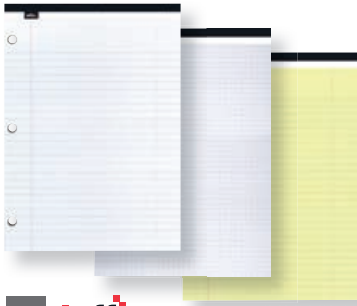

**A** **offix**

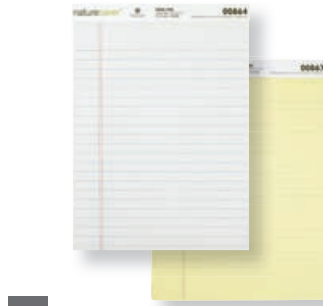

**B** **naturesaver**



**A Offix® Note Pads**

50 detachable sheets. Ruled sheets are 11/32 ruled.  
**5 x 8-3/4 in.**  
**NVX 351734** (351734) ruled, white  
**NVX590836** (590836) ruled, yellow  
**8-1/2 x 11-3/4 in.**  
**NVX 351759** (351759) ruled, white  
**NVX 351742** (351742) quadruled, white  
**NVX 351767** (351767) ruled, 3-hole punched, white  
**NVX 351726** (351726) ruled, yellow  
**8-1/2 x 14-3/4 in.**  
**NVX590828** (590828) ruled, white  
**NVX 590802** (590802) ruled, yellow

**B Recycled Writing Pad**

50 ruled sheets. Ruled 1/4 in. 100% post-consumer recycled content.  
**5 x 8 in.**  
**NAT 00863** (1046151) white  
**8-1/2 x 11-3/4 in.**  
**NAT 00864** (1046226) white  
**NAT 00867** (1046218) yellow



**C** **AMPAD™**



**D** **Enviro Plus™**



**C Earthwise™ Ampad™ Recycled Ruled Sheet Pad**

Water-based soy ink. Micro-perforated. Wide ruling. 40 sheets.  
 100% recycled content, 100% post-consumer waste.  
**TOP 40112** (226183) 5 x 7 (pkg 6)  
**TOP 40102** (226225) 8-1/2 x 11 in. (pkg 4)

**D Enviro Plus™ Recycled Paper Pad**

50 wide ruled sheets. 8-1/2 x 11 in. Package of 5.  
 100% recycled content.  
**HLR 51056** (347625)



**E** **OffiSmart**



**F** **TOPS PRODUCTS**



**E Offisart Colour Notepad**

Ruled sheets.  
**5 x 8 in. - 90 sheets - 3 assorted colours**  
**AVD A00127** (833022) pastel  
**AVD A00128** (833023) bright  
**8-1/2 x 11 in. - 60 sheets - 4 assorted colours**  
**AVD A00125** (833020) pastel  
**AVD A00126** (833021) bright

**F Engineering Computation Pad**

Green tint paper. 3-hole punched. 100 sheets.  
 Quadruled 5 sq./in. 8-1/2 x 11 in. Green.  
**TOP 35500** (1046036)

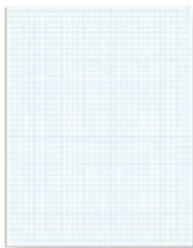

**G** **TOPS PRODUCTS**



**H** **Hilroy**



**I** **Hilroy**



**G Quadrille Pad**

Printed on 2 sides. Heavyweight paper (20 lb). 50 sheets.  
 Quadruled 4 sq./in. 8-1/2 x 11 in. White.  
**TOP 33041** (595736)

**H White Figuring Pad**

96 sheets.  
**8-3/8 x 10-7/8 in.**  
**HLR51252** (546556) quadruled 5 sq./in. (5)  
**HLR51240** (112706) ruled 1/4 in. (5)  
**HLR51250** (135871) ruled 5/16 in. (5)  
**HLR51270** (135863) quadruled 4 sq./in. (5)  
**HLR 51254** (546564)  
 ruled 5/16 in - 3-hole punched (5)  
**HLR 51152** (135855) quadruled 5 sq./in. (10)  
**8-3/8 x 14 in.**  
**HLR 51440** (112722) quadruled 4 sq./in. (5)  
**HLR 51450** (112730) ruled 5/16 in (5)

**I Canary Figuring Pad**

Package of 5.  
**5 x 8 in. - 64 sheets - bond**  
**HLR 51041** (135848) ruled 1/4 in.  
**8-3/4 x 10-7/8 in. - 72 sheets - newsprint**  
**HLR 51039** (283135) ruled 5/16 in.  
**8-3/4 x 10-7/8 in. - 80 sheets - bond**  
**HLR 51251** (112714) ruled 5/16 in.  
**8-3/8 x 14 in. - 90 sheets - bond**  
**HLR 51451** (112748) ruled 5/16 in.



**J** **offix**



**J Offix® White Paper Pad**

72 sheets. Letter size. Package of 5.  
**NVX 349423** (349423) ruled 5/16 in.  
**NVX 349431** (349431) quadruled, 4 sq./in.

## A Reinforced Ruled Loose-Leaf Sheets

20 lb. Triangular holes resist tearing from rings.  
10-7/8 x 8-1/2 in. Package of 100 sheets. SFI certified.  
HLR 05000 (433409)

## B Five Star® Loose-Leaf Sheets

Heavyweight 24 lb paper. 3 hole-punched.  
10-7/8 x 8-3/8 in. SFI certified.  
HLR05237 (135798) ruled (pkg 200)  
HLR 66376 (135806) quadrupled (pkg 100)

## C Recycled Ruled Loose-Leaf Sheets

3-hole punched. 150 sheets. Letter size.  
30% post-consumer waste.  
HLR 05470 (774539)

## D Loose Leaf Sheets

Hole-punched. 10-7/8 x 8-3/8". Package of 200.

**8-3/8 x 5-7/16 in. - ruled**

HLR 05851 (222729) (pkg 50)

**10-7/8 x 8-3/8 in. - ruled**

HLR 05233 (25809) pkg 200

**10-7/8 x 8-3/8 in. - plain**

HLR05225 (534966) pkg 200

HLR05240 (232173) pkg 400

**10-7/8 x 8-3/8 in. - quadrupled**

HLR05271 (268664) 10 sq./cm (pkg 20)

HLR05281 (222711) 4 sq./in. (pkg 50)

HLR 05291 (267849) 5 sq./in (pkg 50)

## E Mylar Reinforced Loose Leaf Paper

3-hole punched, mylar reinforced edge. 20 lb. 8-1/2 x 11 in.  
Package of 100. 50% post-consumer recycled content.  
SPRWB213 (1046846) plain  
SPR WB213R (1046854) ruled

## F 3-Hole Punched Loose Leaf Paper

8 x 10-1/2 in. - **16 lb paper**  
SPR 82124 (1046895) narrow ruled (pkg 200)  
SPR 82121 (1046903) wide ruled (pkg 150)  
SPR82122 (1046911) wide ruled (pkg 200)  
8-1/2 x 11 in. - **20 lb paper**  
SPR 82110 (1046861) narrow ruled (pkg 100)  
SPR 82120 (1046879) narrow ruled (pkg 200)

## G College Ruled Refill Paper

Sized for a binder or a planner. 7-hole punched ruled sheets.  
5-1/2 x 8-1/2 in. Package of 100.  
AVE 14230 (190207)

## H Ruled Loose Leaf Sheets

6-hole-punched paper. 3-3/4 x 6-3/4 in. Package of 50.  
HLR 45710 (222950)



**A FIVE STAR**  
★★★★★



**B FIVE STAR**  
★★★★★



**C ENVIRO PLUS**



**D Hilroy**



**E Sparco**



**F Sparco**



**G AVERY**

**H Hilroy**



**A** OffiSmart



**B** Hilroy

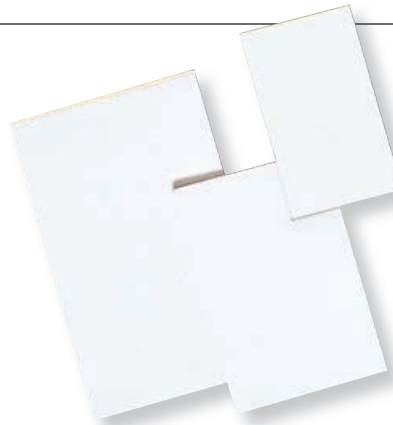

**A OffiSmart Colour Paper Cube**

300 sheets, 3-1/2 x 3-1/2 in. 5 colours.  
**AVD A00123** (833018) pastel  
**AVD A00124** (833019) neon

**B Plain White Paper Pad**

Plain paper pads. 96 sheets.  
**Sold by each**  
**HLR 50912** (48512) 8-3/8 x 10-7/8 in.  
**Package of 10**  
**HLR 50305** (666503) 3 x 5 in.  
**HLR 50407** (666511) 4 x 6 in.  
**HLR 50509** (666529) 5 x 8 in.

**C While You Were Out Message Pads**

50 sheets per pad. English. 4-1/4 x 5-1/2 in. Package of 6.  
 Assorted colours  
**ABF 9711NEON** (1046937)



**C** adams™



**D** Hilroy

**D Telephone Message Pad**

72-sheet pad, 3-1/2 x 5 in. Pink.  
**Package of 10**  
**HLR 46554** (546572) English  
**Package of 25**  
**HLR 46524** (662510) French  
**HLR46501** (588004) English  
**HLR 46505** (662502) Bilingual

**E Telephone message book**

Duplicate message. Carbonless paper. 4 per page. 400 messages.  
 11 x 5-11/16 in.  
**Sold by each**  
**BLIA1630FT** (247551) French  
**BLIA1630T** (247577) English  
**Package of 2**  
**BLI D50977** (1046978) English

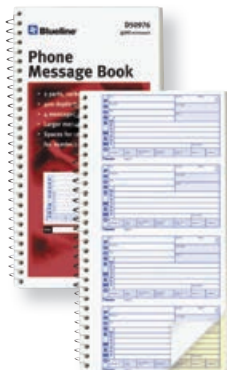

**E** Blueline®



**F** Hilroy



**F Voicemail log book**

Spiral bound. 100 pages, 5 messages per page. Perforated preprinted sheets. Bilingual. 6-1/4 x 8-7/8 in.  
**HLR 46215** (780676)

**G Voicemail Log Book**

Spiral bound. 100 pages. 8-3/8 x 8-1/4 po. Bilingual. 50% post-consumer recycled content.  
**BLI D1641BT** (113589) 8 messages/page  
**BLI D1642BT** (428490) 14 messages/page

**H Carbonless Important Message Pad**

Spiral bound. 200 sheets, 4 messages per page. 2-part carbonless (pink and canary paper). 11 x 8-1/2 in. English. SFI Certified.  
**ABF SC1184P** (1046929)

**I Phone Message Books**

Spiral bound. 400 sheets, 4 messages per page. 2-part carbonless (white and canary). 11 x 5-1/4 in. English. SFI Certified.  
**ABF SC1154D** (1046960)



**G** Blueline®



**H** adams™

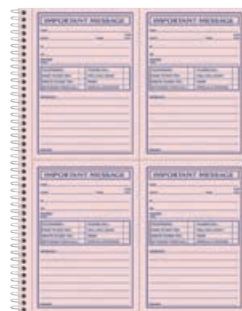

**I** adams™





# It's a date!

Watch for our newest **Time Management** solutions available **in August!**





**A**  **Blueline®**

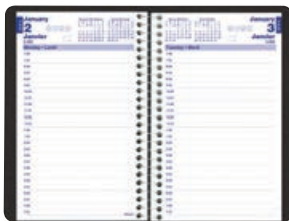

**B**  **Blueline®**



**A PlannerPLUS Daily Diary**

8 x 5 in. 7:00 a.m. to 7:30 p.m., 30-minute schedule. Repositionable self-stick notes booklet included. Soft cover. Bilingual. Black.  
**BLI C1504N81BT** (736223)

**B Daily Diary**

8 x 5 in. 7:00 a.m. to 7:30 p.m., 30-minute schedule. Soft cover. Black.  
**BLIC2504-81BT** (327668) Bilingual  
**BLI C2504-81T** (425066) English

**C Daily Diary**

8 x 5 in. 7:00 a.m. to 7:30 p.m., 30-minute schedule. Soft cover. Bilingual  
**BLIC1504-81BT** (15453) black  
**BLI C1504-82BT** (28704) blue  
**BLI C1504-83BT** (28712) burgundy  
 English  
**BLI C1504-81T** (139220) black  
**BLI C1504-82T** (620195) blue  
**BLI C1504-83T** (178624) burgundy



**C**  **Blueline®**



**D**  **Brownline®**



**D Daily Diary**

8 x 5 in. 7:00 a.m. to 7:30 p.m., 30-minute schedule. Each page has 3 blocks for reminder notes and calls. Self-adhesive laminated tabs. English. Black.  
**BLI CB634W-BK** (292623) soft cover  
**BLI CB634C-BK** (292566) hard cover

**E Weekly Diary**

8 x 5 in. 7:00 a.m. to 6:00 p.m., hourly schedule. Soft cover. Bilingual.  
**BLI C510081BTX** (16295) black  
**BLI C510082BTX** (28936) blue

**F Timanager® Weekly Diary**

8-1/2 x 6-3/4 in. 7:00 a.m. to 7:30 p.m., 30-minute schedule. Soft cover. Bilingual.  
**BLICBBM2-BK** (651422) black  
**BLI CBBM2-PNK** (766931) pink daisy



**E**  **Blueline®**



**F**  **Blueline®**



**G Weekly Diary**

11 x 9-1/16 in. 7:00 a.m. to 8:45 p.m., 15-minute schedule. Bilingual. Black.  
**BLIC5950-81BT** (121434) soft cover  
**BLI C5950V81BT** (161018) Duraflex cover

**H 7-Day Timanager® Weekly Diary**

11 x 8-1/2 in. 7:00 a.m. to 8:30 p.m., 30-minute schedule. Soft cover. Black.  
**BLI C5930-81FT** (242297) French  
**BLI C5930-81T** (242354) English



**G**  **Blueline®**

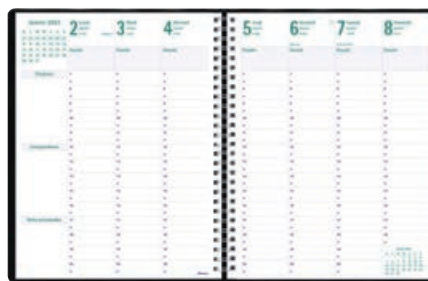

**H**  **Blueline®**



## A Traditional Weekly Diary

8 x 5 in. No appointment schedule.  
Soft cover. Bilingual. Metallic grey.  
**AAG GC200F4523** (221655)

## B Weekly Diary

8:00 a.m. to 5:00 p.m., hourly schedule. Soft cover.  
Bilingual. Black.  
**AAGGF2500023** (691774) 3-3/4 x 6 in.  
**AAG GF2100023** (691824) 4-7/8 x 8 in.

## C Ministre Weekly Diary

9-1/2 x 6-1/4 in. 8:00 a.m. to 9:00 p.m., 30-minute schedule.  
Soft cover. Black.

### Complete diary

**QUO 15102F01** (454314) French  
**QUO 15102E02** (454215) English

### • Refill

**QUO 15001F** (45906) French  
**QUO 15001E** (45989) English

## D President Weekly Diary

10-3/4 x 8-1/4 in. 8:00 a.m. to 9:00 p.m., 30-minute schedule.  
Soft cover. Black.

### Complete diary

**QUO 16102F01** (454322) French  
**QUO 16102E02** (454223) English

### • Refill

**QUO 16001F** (45898) French  
**QUO 16001E** (45963) English

## E MiracleBind™ Monthly Diary

16 months: September to December. Bilingual. Black.

### Soft cover

**BLI CF151281BT** (133694) 11 X 9-1/16 in.

### CoilPro hard cover

**BLI CF1200C81B** (311670) 9-1/4 x 7-1/4 in.  
**BLI CF1512C81B** (233684) 11 X 9-1/16 in.

## F 16-Month Monthly Diary

September to December the following year. Soft cover.  
Bilingual. Black.

**BLI C1200-81BT** (121442) 9-1/4 x 7-1/4 in.  
**BLI C1512-81BT** (327676) 11 x 9-1/16 in.

## G 14-Month Monthly Diary

December to January the following year. Soft cover.  
English. Black.

### Soft cover

**BLICB1200-BK** (292599) 8-7/8 x 7-1/8 in.  
**BLI CB1262-BK** (428169) 11 x 8-1/2 in.

### CoilPro hard cover

**BLICB1200CBLK** (292615) 8-7/8 x 7-1/8 in.





**A**

**Blueline®**



**B**

**Blueline®**



**A NotePro® Daily Undated Planner**

Planner on left side and ruled page with margin on right side. Index sheet, self-adhesive tabs, complete utility section and storage pocket. Refillable with the MiracleBind sheets. Hard cover. Black.

**9-1/4 x 7-1/4 in. - 192 pages**

**BLI A29C-81B** (670208) Bilingual

**BLI A29C-81** (311605) English

**10-3/4 x 8-1/2 in. - 200 pages**

**BLI A30C-81B** (239962) Bilingual

**BLI A30C-81** (311621) English

**B Daily Undated Planner**

8 x 5 in. 8:00 a.m. to 8:00 p.m., hourly schedule. Soft cover. Bilingual. Black.

**BLI A6236-81BT** (28829)

**C Fresno Planner**

Vinyl. Zippered closure. 7-ring. Includes 3 months of undated pages. Bilingual. Black.

**Portable size, 3-3/4 x 6-3/4 in.**

**DTM 68333** (715615)

**Desk size, 5-1/2 x 8-1/2 in.**

**DTM 68331** (707521)

**D Visitors Register**

8-1/2 x 9-11/16 in. Includes the following sections : date, name, badge number, company, To See, arrival (hour), departure (hour). 128 pages. Grey imprint with bookmark. Bilingual. Black.

**BLI A2006BBLK** (768648)

**E Undated Reversible Wall Planner**

Write-on, wipe-off surface. 1-month/2-month. Bilingual.

**DTM 59736** (292326) 17 x 24 in.

**DTM 59735** (700443) 23 x 30 in.

**DTM 59734** (700450) 24 x 36 in.

**F Reversible Wall Planner**

24 x 36 in. Dated. Vertical on one side, horizontal on the other. Annual. Bilingual.

**DTM03744-23** (137083)

**G Wallmates® Self-Adhesive Monthly Planning Surface**

18 x 24 in. Peel and stick self-adhesive. Repositionable, dry erase surface leaves no residue. Includes a dry-erase marker. Bilingual.

**AAG AW5021-28** (185777) undated 1 month/2months

**AAG AW50612823** (185785) dated - January-December

**H Perpetual Wall Planner**

Write-on, wipe-off surface. Rigid board with vinyl frame. Includes tray and double-sided tape. 24 x 36 in. Bilingual.

**DTM 59730** (700427) 1 month

**DTM59731** (700435) 4 months



**C**

**DAY-TIMER®**

**D**

**Blueline®**

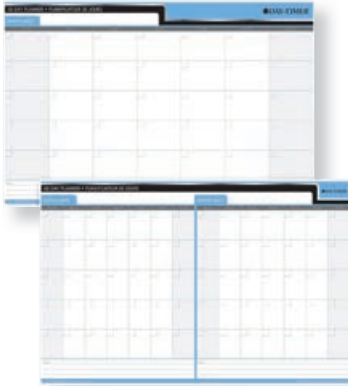

**E**

**DAY-TIMER®**



**F**

**DAY-TIMER®**

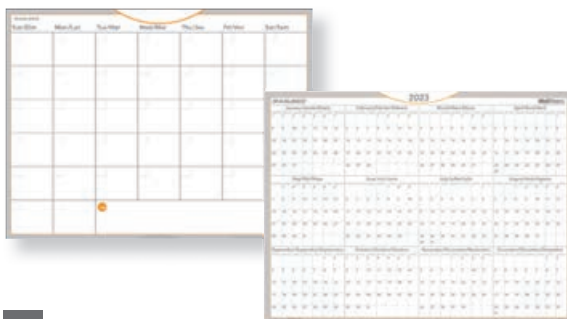

**G**

**AT-A-GLANCE®**

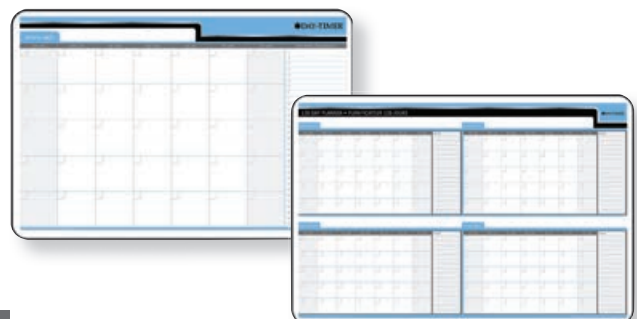

**H**

**DAY-TIMER®**

## A Monthly Desk Pad Calendar

One tear-off sheet per month. Annual calendar at the bottom of each page. One block per day.

**17-3/4 x 10-7/8 in.**

**BLI C181700B** (1047273) Bilingual

**BLI C181700** (514679) English

**21-1/4 x 16 in.**

**BLIC181731B** (6361) Bilingual

**BLIC181731** (139303) English

**21-1/4 x 16 in. Transparent vinyl strip at the bottom.**

**BLIC181731BV** (292532) Bilingual



**A** **Blueline®**

## B Undated Monthly Desk Pad Calendar

22 x 17 in. Reinforced corners and back. 12 microperforated sheets attached at the top. Annual calendars in reference on each side.

Bilingual.

**BLI A181722B** (402594)

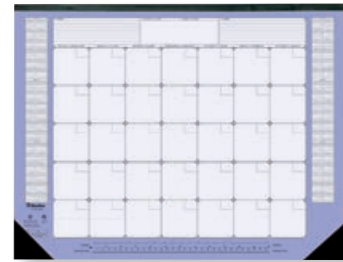

**B** **Blueline®**

## C Pink Daisy Monthly Desk Pad Calendar

22 x 17 in. Images of a different flower each month. Tear-away sheets.

Clear vinyl corners. Annual calendar at the bottom of each page.

Bilingual.

**BLI C1831BPNK** (783514)



**C** **Blueline®**

## D DuraGlobe Monthly Desk Pad Calendar

22 x 17 in. Reinforced cardboard pad. One tear-off sheet per month.

Annual calendar at the bottom of each page. One block per day.

Bamboo fiber paper.

**BLI C177227B** (183731) Bilingual

**BLI C177227** (1047281) English



**D** **Blueline®**

## E EcoLogix® Monthly Desk Pad Calendar

22 x 17 in. Discover a new ecological tip each month. One tear-away sheet per month.

Notes section on the side. Annual calendar at the bottom of each page. Bilingual.

**BLI C177437B** (783522)



**E** **Blueline®**

## F Canadian Landscape Wall Calendar

12 x 11 in. 16 months: September to December. Features 13 full colour images of beautiful Canadian landscapes.

Past and future month reference. Bilingual.

**AAG DDF7072823** (292938)



**F** **Mead**

## G Net Zero Carbon™ Wall Calendar

12 x 17 in. One month on each sheet, one block per day. Twin-wire binding with eyelet. Yearly calendar at the bottom of each sheet.

Bilingual.

**BLI C171303B** (327593)



**G** **Blueline®**

## H Watercolour Monthly Wall Calendar

12 x 17 in. 12 months. One month per sheet, one bloc per day. Annual calendar at the bottom of each sheet.

Reinforced cardboard support.

Double spiral binding with eyelet for hanging. Bilingual.

**BLI C173126B** (823703)



**H** **Blueline®**



**A**



**B**



**A Post-It® Flags Value Pack**

120, 1 in. flags and 200 1/2 in. flags. Assorted colours.  
**MMM 683-XL1** (536193)

**B Post-It® Sign Here Flags Value Pack**

Includes 4 packs of 50 1" flags. Bonus: 2 packs of 24 arrow flags of 1/2".  
**MMM 680-SH4VA** (530030)

**C Post-It® Sign Here Arrow Flags**

1/2 x 1 1/2 in. 4 dispenser pads.  
**MMM684-RDSH** (570648) red (80 flags)  
**MMM684-SH** (376947) assorted colours (120 flags)

**D Post-It® Icon Flags**

50 flags per dispenser. 1 x 1 1/2".  
**Sold by each**  
**MMM 680-31** (420943) "Signature"  
**MMM 680-9** (473298) "Sign here"  
**Package of 2**  
**MMM 680-IH2** (538413) "Initial here"  
**MMM 680-SD2** (598094) "Sign & Date"

**E Post-It® Arrow-Shaped Flags**

Package of 96 arrow-shaped flags. 0.47 x 1 1/2". 4 assorted colours.  
**MMM 684-ARR3** (623645) standard  
**MMM 684-ARR4** (623652) bright

**F Post-It® Arrow Flags**

Package of 100. Arrow-shaped flags. 0.47 x 1 1/2". 5 assorted colours.  
**MMM 684-ARR1** (467126) standard  
**MMM 684-ARR2** (600353) bright

**G Post-It® Page Markers**

1 x 3 in. 4 pads of 50 page markers. Fluorescent colours.  
**MMM 671-4AU** (559591)

**H Post-It® Page Markers**

1/2 x 2". Assorted.  
**5 pads of 50 page markers**  
**MMM 670-5AF** (607077) fluorescent colours  
**5 pads of 100 page markers**  
**MMM 670-5AU** (468694) bright colours  
**MMM 670-5AN** (607069) fluorescent colours

**I Post-It® Metallic Colour Flags**

5" x 1 1/2". 100 flags with dispenser. Assorted designs.  
**MMM 684-METAL** (1049238)

**J Post-It® Notes and Flags Combo**

9 pads of 50 sheets each: 1 of 3 x 4 in., 3 of 7/8 x 2-7/8 in. and 5 of 1/2 x 1 1/2 in. Repositionable. Assorted colours.  
**MMM 670COMBO-C** (587485)



**C**



**D**



**E**

**F**



**G**

**H**

**I**

**J**

## A Post-it® Flags

50 flags per dispenser. 1 x 1.7 in. Package of 2.

- MMM 680-BP2 (829818) pink
- MMM 680-BB2 (829824) blue
- MMM 680-BE2 (829825) light blue
- MMM 680-BG2 (829820) light green
- MMM 680-GN2 (829827) green
- MMM 680-OE2 (829821) orange
- MMM 680-PU2 (829823) purple
- MMM 680-RD2 (829826) red
- MMM 680-WE2 (829822) white
- MMM 680-YW2 (829819) yellow



A



## B Post-It® Deskrip Flag Dispenser

Deskrip dispenser of 200 flags. 1 x 1.7 in.

- MMM 680-HVYW (570481) yellow
- MMM 680-HVBE (594929) blue
- MMM 680-HVRD (594937) red

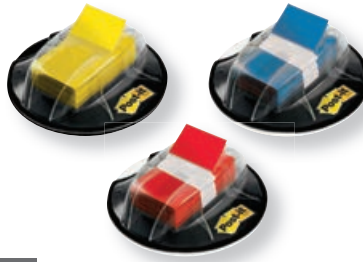

B

## C Post-It® Flags

3 pads of 20 flags. 1 x 1.75". 3 colours.

- MMM680-PBGB (115337) violet, blue, green
- MMM 6800LP (521153) orange, green, pink



C

## D Post-It® Flags

Three packages of 20 flags. 1 x 1.75 in. Six alternating colours.

- MMM680-EGALTC (187328)



D

## E Post-It® Flags Value Pack

Includes 4 packs of 50 flags. 25 yellow flags bonus pack. 1 in. x 1.7 in.

- MMM 680RYBGVAB (734533)



E



## F Post-It® Flags

160 flags in packages of 20. 1" x 1.75". 4 colours.

- MMM 680RYGB2BB (788539) red, yellow, blue, green
- MMM 680-PG0P2 (788521) pink, green, orange, purple



F

## G Post-It® Flags Value Pack

Includes 4 packs of 50 1" flags. Bonus: 2 packs of 24 arrow flags of 1/2".

- MMM 680PPBGVAB (734525)



G



## H Post-It® Flags Value Pack

Dispenser of 280 flags in 8 assorted colours. Bonus: 48 arrow flags in 2 colours. 0.4" x 1.7".

- MMM 683-VAD1 (115352)



H



## I Post-It® Flags

Dispenser of 140 flags in 4 assorted colours. 0.4" x 1.7".

- MMM 683-4 (623637) standard
- MMM 683-4AB (623892) bright



I

## J Post-It® Flags

Package of 100. 5 assorted colours. 0.5 x 1.7".

- MMM683-5CB2 (379073) bright
- MMM 683-5CF (482687) standard



J



**A**



**B**

**A Post-it® Filing Tabs**

Large writing area ideal to organize catalogues, files and folders. Repositionable and durable. 2" wide. Tabs in 4 colours. Package of 24.  
**MMM 686ALYRC** (166280) primary colours  
**MMM 686-24WE-C** (187302) white  
**MMM686PLOVC** (187468) bright colours

**B Post-it® Angled Self-Adhesive Tabs**

Angled to facilitate viewing in filing drawers. 2 x 1-1/2". Package of 24 tabs.  
**MMM 686A-ALYRC** (187344)

**C Post-it® 4-Colour Tabs**

Easy to remove and reposition. 5/8" x 1-1/2". 4 colours per pack, 40 tabs per pack.  
**MMM676-ALYR-C** (272211) blue, green, yellow and red  
**MMM 676-AYPV** (596759) blue, yellow, pink and purple



**C**



**D**

**D Post-it® Durable Index Tabs**

66, 1 x 1-1/2" durable tabs. Writable and repositionable. 3 colours.  
**MMM 686-RYB** (636563) red, yellow, blue  
**MMM 686-PGO** (661298) pink, green, orange  
**MMM 686L-GBR** (757922) green, blue, red  
**MMM 686L-PGO** (769398) pink, green, orange

**E Post-it® Flags and Tabs Value Pack**

36 tabs size 1 x 1.5 in. 100 flags size 0.47 x 1.7 in. Assorted colours.  
**MMM 595835** (595835)

**F Post-it® Pop-Up Notes Dispenser**

3 x 3 in. Pop-Up vertical notes dispenser with pen holder. Includes one Aqua 45-sheet pad.  
**MMM ABS-330-B** (591081) black and grey  
**MMM ABS-330-W** (591073) white and grey

**G Post-it® Wave Pop-Up Notes Dispenser**

Dispenser holds 3 x 3 in Pop-up notes. Wave design pattern on all sides. Navy.  
**MMM WAVE330MI** (806456)

**H Post-it® Pop-Up Note Dispenser**

Weighted dispenser. 4 x 4 in. 3 ruled pads included. Black and clear.  
**MMM DS440SSVP** (1049345)  
 • Dispenser only  
**MMM DS440** (1049337)

**I Post-it® Pop-Up Notes Dispenser**

Weighted base. For pop-up notes, 3 x 3".  
**MMM STL330-B** (573725) black



**E**



**F**



**G**



**H**

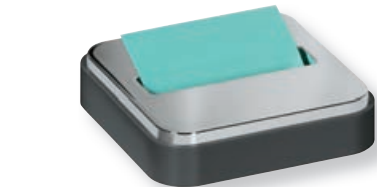

**I**



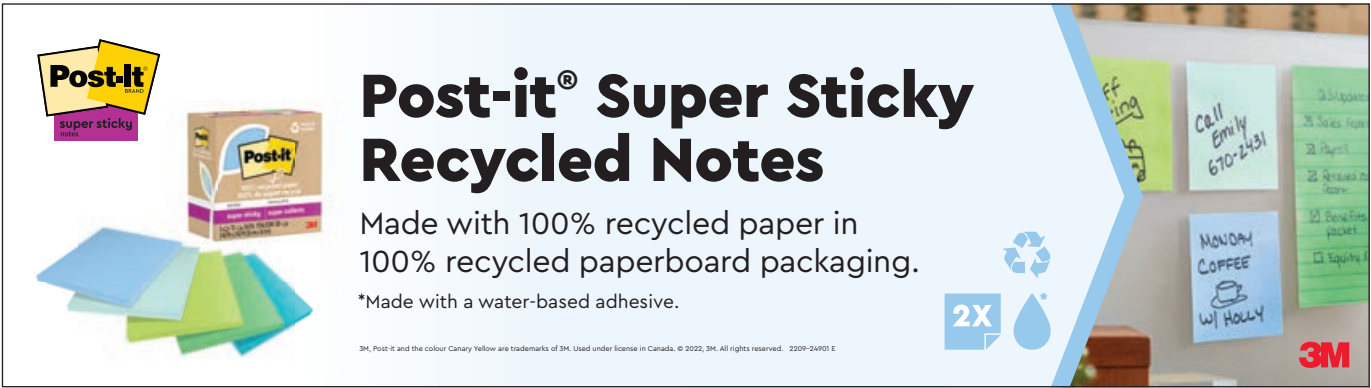

# Post-it® Super Sticky Recycled Notes

Made with 100% recycled paper in 100% recycled paperboard packaging.

\*Made with a water-based adhesive.

2X

3M

**A Wanderlust Pastels Collection**

- Plain**  
 MMM 833047 (833047) 3 x 3 in. (pkg 12)  
 MMM833045 (833045) 3 x 3 in. (pkg 24)
- Ruled**  
 MMM 675R3SSNRP (833050) 4 x 4 in. (pkg 3)  
 MMM 833049 (833049) 4 x 6 in. (pkg 4)
- Pop-Up**  
 MMM 833048 (833048) 3 x 3 in. (pkg 6)



**A** **B**

**N 2023**

**2023**

**B Oasis Collection**

- Plain**  
 MMM 654R-5SST (833052) 3 x 3 in. (pkg 5)  
 MMM 654R-12SST (833053) 3 x 3 in. (pkg 12)  
 MMM833051 (833051) 3 x 3 in. (pkg 24)
- Ruled**  
 MMM 675R-3SST (833056) 4 x 4 in. (pkg 3)  
 MMM 4621R-4SST (833055) 4 x 6 in. (pkg 4)
- Pop-Up**  
 MMM R330R-6SST (833054) 3 x 3 in. (pkg 6)

**C Canary Yellow**

- Plain**  
 MMM 654R-5SSCY (833040) 3 x 3 in. (pkg 5)  
 MMM 654R12SSCY (833041) 3 x 3 in. (pkg 12)  
 MMM 833039 (833039) 3 x 3 in. (pkg 24)  
 MMM 655R12SSCY (833043) 3 x 5 in. (pkg 12)
- Ruled**  
 MMM 4621R4SSCY (833044) 4 x 6 in. (pkg 4)
- Pop-Up**  
 MMM R330R6SSCY (833042) 3 x 3 in. (pkg 6)



**C** **D**

**N 2023**

**2023**

**D Post-It® Super Sticky Pop-Up Notes**

- 3 x 3 in. Hold stronger and longer. Pad of 90 sheets. Package of 6.
- Pop-Up**  
 MMM R3306SSCYC (769323) 3 x 3 in. (pkg 6)
- Ruled**  
 MMM 660-3SSCY (823680) 4 x 6 in. (pkg 3)

**E Post-It® Self-Adhesive Pop-Up Notes**

- 3 x 3 in. Pad of 90 sheets. Package of 24 pads. Yellow.
- Plain**  
 MMM R3306YW-CA (661397) 3 x 3 in. (pkg 6)  
 MMM R330-24VAD (205054) 3 x 3 in. (pkg 24)
- Ruled**  
 MMM R3306-YL-C (661405) 3 x 3 in. (pkg 6)



**E** **F**

**F Post-It® Super Sticky Pop-Up Notes**

- 4 x 4 in. Ruled. Hold stronger and longer. Pad of 90 sheets. Package of 5.
- MMM R440WASS (1049030) aqua wave  
 MMM R440NPSS (1049048) pink neon

**G Post-It® Pop-Up Notes Cabinet Pack**

- 3" x 3". Canary yellow notes. 90 sheets per pad. Box of 18 pads.  
 MMM R330-18CPC (550525)



**G**



New colours



**A**

New colours



**B**

New colours

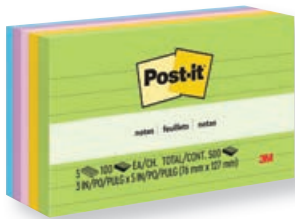

**C**



**D**



New colours



**E**



**F**

New colours



**G**



**H**



**I**

**A Post-it® Super Sticky Notes - Energy Boost Collection**

Sticks to almost any surface. Made with plant-based adhesive. All Post-it® Notes are recyclable.

- Plain**
- MMM 828103 (828103) 3 x 3 in. (pkg 18)
- MMM 6445-SSP (734558) 6 x 4 in. (pkg 8)
- Ruled**
- MMM 5845-SS (235689) 5 x 8 in. (pkg 2)

**B Post-it® Notes – Poptimistic Collection**

Sticks to almost any surface. Made with plant-based adhesive. All Post-it® Notes are recyclable.

- Plain**
- MMM 653AN (289173) 1-1/2 x 2 in. (pkg 12)
- MMM 654-5PK (280016) 3 x 3 in. (pkg 5)
- MMM 675-5LAN (806471) 4 x 4 in. (pkg 5)
- Ruled**
- MMM630-6AN (606988) 3 x 3 in. (pkg 6)
- MMM 660-3AN (481382) 4 x 6 in. (pkg 3)

**C Post-it® Self-Adhesive Notes – Floral Fantasy Collection**

Sticks to almost any surface. Made with plant-based adhesive. All Post-it® Notes are recyclable.

- Plain**
- MMM 654-5UC (420851) 3 x 3 in. (pkg 5)
- MMM 655-5UC (420869) 3 x 5 in. (pkg 5)
- Lined**
- MMM635-5AU (607028) 3 x 5 in. (pkg 5)
- MMM 660-3AU (282822) 4 x 6 in. (pkg 3)
- Pop-Up**
- MMM R3306AU12C (661439) 3 x 3 in. (pqt 6)

**D Post-it® Super Sticky Notes - Summer Joy Collection**

Sticks to almost any surface. Made with plant-based adhesive. All Post-it® Notes are recyclable.

- Plain**
- MMM 654-5SSJOY (829146) 3 x 3 in. (pkg 5)
- MMM 833194 (833194) 3 x 3 in. (pkg 24)
- Ruled**
- MMM 660-3SSJOY (829147) 4 x 6 in. (pkg 5)

**E Post-it® Self-Adhesive Notes – Beachside Café Collection**

Sticks to almost any surface. Made with plant-based adhesive. All Post-it® Notes are recyclable.

- MMM 653-AST (661280) 1-1/2 x 2 in. (pkg 12)
- MMM 65324APVAD (833145) 3 x 3 in. (pkg 24)

**F Post-it® Self-Adhesive Notes Cube**

- 2 x 2 in.
- MMM 2051-EB0-R (225763) bright
- MMM2051-FLT (691295) pastel
- 3 x 3 in.
- MMM 2056-PP (757930) bright

**G Post-it® Super Sticky Notes - Supernova Neons Collection**

Sticks to almost any surface. Made with plant-based adhesive. All Post-it® Notes are recyclable.

- 2 x 2 in. - 90-sheet pad (pkg 8)
- MMM 622-8SSMIA (371666)
- 3 x 3 in. - 90-sheet pad (pkg 5)
- MMM 654-5SSMIA (371674)
- 4 x 4 in., lined - 70-sheet pad (pkg 3)
- MMM 675-3SSMIA (371690)
- 4 x 6 in., lined - 90-sheet pad (pkg 3)
- MMM 660-3SSMIA (371682)

**H Post-it® Super Sticky Notes - Energy Boost Collection**

Sticks to almost any surface. Made with plant-based adhesive. All Post-it® Notes are recyclable.

- 3 x 3 in. - 90-sheet pad (pkg 5)
- MMM 654-5SSUC (756213)
- 4 x 6 in., lined - 90-sheet pad (pkg 3)
- MMM 660-3SSUC (756221)

**I Post-it® Super Sticky Notes**

Hold stronger and longer. Pad of 90 sheets. Made with plant-based adhesive. Yellow.

- Ruled**
- MMM 622-10SSCY (714022) 2 x 2 in. (pkg 10)
- MMM 654-12SSCY (713990) 3 x 3 in. (pkg 12)
- MMM 655SSCYC (154591) 3 x 5 in. (pkg 12)
- Ruled**
- MMM 6753SSCYC (734376) 4 x 4 in. (pkg 3)

## A Post-It® Super Sticky Notes

15 pads of 45 sheets each. Assorted colours. 3 x 3 in.  
MMM 654-15SSCP (828098)



**A**



**B**

## B Post-It® Transparent Notes

36 sheets. 2-7/8 x 2-7/8 in. 1 pd.  
MMM 600-TRSP (833193)



## C Post-It® Super Sticky Full Stick Notes

Hold securely to the inside of planners, ring binders and calendars. Full adhesion across the back of each note so the whole pad stays together when it is stuck to a surface. 30 sheets per pad.

### Energy Boost collection

MMM F220-8SSAU (226035) 2 x 2 in. (pkg 8)

MMM F330-4SSAU (187526) 3 x 3 in. (pkg 4)

MMM F33012SSAU (187567) 3 x 3 in. (pkg 12)

### Yellow

MMM F330-12SSY (187575) 3 x 3 in. (pkg 12)



## D Post-It® Special Notes

Pad of 150 sheets in two colours. With 65% plant-based adhesive.

MMM 7350-APL (147827) apple

MMM 7350-BLB (371799) bubble

MMM7350-DSY (147785) flower

MMM7350-STR (579680) star

MMM7350-HRTC (147793) heart



**C**

**D**

## E Post-It® Super Sticky Notes

3 x 3 in. Holds stronger and longer. 90-sheet pads. Single colour packs are great for creating murals, or colour-coding. 5 per package.

MMM 654-5SSBE (588194) electric blue

MMM 654-5SSLE (588202) limeade

MMM 654-5SSNO (588210) neon orange

MMM 654-5SSNP (588228) neon pink

MMM654-5SSRR (588236) candy red

MMM 654-5SSSC (588251) black

MMM 654-5SSW (588269) white

MMM654-5SSY (588244) electric yellow



## F Post-It® Self-Adhesive Notes Value Pack

Value pack contains 24 pads of 90 sheets. 3 x 3 in. Assorted colours.

MMM 654-CYP24C (243386)



**E**

**F**

## G Post-It® Super Sticky Notes Cabinet Pack

### Cabinet Pack

3 x 3 in. Canary Yellow notes. 90 sheets per pad. Box of 24 pads.

MMM 654-24SSCP (282798)



## H Post-It® Self-Adhesive Notes

Pad of 100 sheets. Yellow.

### Plain

MMM 653 (229427) 1-1/2 x 2 in. (pkg 12)

MMM 654 (108357) 3 x 3 in. (pkg 12)

MMM 655 (182956) 3 x 5 in. (pkg 12)

MMM 659 (118828) 4 x 6 in. (pkg 1)

### Ruled

MMM 630-6PK (467092) 3 x 3 in. (pkg 6)

MMM 635 (182436) 3 x 5 in. (pkg 12)

MMM 660 (133835) 4 x 6 in. (pkg 1)

### Pad of 300 ruled sheets

MMM 675-YL (623546) 4 x 4 in. (pkg 1)



**G**



## I Post-It® Notes Cabinet Pack

3 x 3 in. Canary Yellow notes. 90 sheets per pad. Box of 24 pads.

MMM 654-24CP (559500)



**H**



**I**



**A Offix® Self-Adhesive Notes**

Pad of 100 sheets. Yellow. Package of 12 pads.  
**NVX 349233** (349233) 1-1/2 x 2 in.  
**NVX 349241** (349241) 3 x 3 in.  
**NVX 349225** (349225) 3 x 5 in.



**B Self Adhesive Notes**

Pads of 100 sheets. Extreme assorted colours. Package of 12.  
**BSN 16498** (1048800) 1-1/2 x 2 in.  
**BSN 36615** (1048735) 3 x 3 in.

**C Self Adhesive Notes**

Pad of 100 sheets. Yellow.  
**Plain**  
**BSN36610** (1048751) 1-1/2 x 2 in. (pkg 12)  
**BSN36612** (1048743) 3 x 3 in. (pkg 12)  
**BSN36616** (1048834) 3 x 3 in. (pkg 24)  
**BSN36613** (1048850) 3 x 5 in. (pkg 12)  
**Ruled**  
**BSN 36618** (1048875) 4 x 6 in. (pkg 12)

**D Self Adhesive Notes**

100-sheet pads. Assorted pastel colours.  
**Plain**  
**BSN 16500** (1048826) 1-1/2 x 2 in. (pkg 12)  
**BSN 36614** (1048768) 3 x 3 in. (pkg 12)  
**Ruled**  
**BSN 16501** (1048867) 4 x 6 in. (pkg 5)



**E Self Adhesive Notes**

Pads of 100 sheets. 1-1/2 x 2 in. Assorted neon colours. Package of 12.  
**BSN 16493** (1048818)

**F Self Adhesive Recycled Notes**

Pad of 100 sheets. Yellow. 100% recycled, 30% post-consumer content.  
**3 x 3 in. - plain**  
**BSN 36620** (1048933) pkg 12  
**4 x 6 in. - ruled**  
**BSN 36619** (1048941) pkg 5

**G Offix® Self-Adhesive Pop-Up Notes**

3 x 3 in. pop-up notes. Pad of 100 sheets. Yellow. Package of 12 pads.  
**NVX 349217** (349217)



## A A796 Accounting Book

White paper with green and brown ruling. Black hard cover.  
Size 10-1/4 x 7-11/16". 200 numbered pages. 50% recycled content,  
50% post-consumer waste. FSC® Certified.

### Perfect bound

**BLI A796-01** (216267)

**AccountPro™. Twin-wire bound. 200 pages**

**BLI A796C-01** (696120)

**AccountPro™. Twin-wire bound. 300 pages**

**BLIA7963C-01** (1047547)



**A**  **Blueline®**

## B A790 Accounting Book

Hard cover. White paper with green and brown ruling. 12-1/2 x 7-7/8".  
Numbered pages. 50% recycled content, 50% post-consumer waste.  
FSC® Certified.

### Perfect bound. 200 pages

**BLI A790200-1** (216218) record

**BLI A790200-3** (17715) 3 col.

### Perfect bound. 300 pages

**BLI A790300-1** (216234) record

**AccountPro™. Twin-wire bound. 300 pages**

**BLI A7903C-01** (280602) record



**B**  **Blueline®**



**C**  **Blueline®**

## C A769 Accounting Book

Black flexible cover. Twin-wire bound. White paper with blue and red  
ruling. Detachable headers. 80 numbered pages. Double page. 12 x 15".  
50% recycled content, 50% post-consumer waste. FSC® Certified.

**BLI A769-24T** (304014) 24 col.

**BLI A769-30T** (304048) 30 col.

**BLI A769-36T** (255729) 36 col.

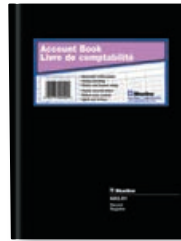

**D**  **Blueline®**



**E**  **Blueline®**



**F**  **Blueline®**

## D A82 Accounting Book

Hard cover with glued binding. White paper with green and brown  
ruling. Numbered lines and columns (except record). 100 pages.  
10-1/4 x 7-11/16". 50% recycled content, 50% post-consumer waste.  
FSC® Certified.

**BLIA82-01** (17806) record

**BLI A82-03** (17822) 3 col.

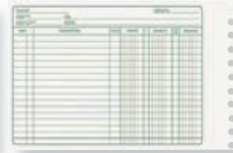

**G**  **Blueline®**

## E A1740 Columnar Book

Hard cover. Green paper with green and brown ruling. Detachable  
headers. 80 numbered pages. 12-1/4 x 9-7/8". 50% recycled content,  
50% post-consumer waste. FSC® Certified.

**BLI A1740-06** (215335) 6 col.

**BLIA1740-12** (1636) 12 col.

**BLI A1740-18** (215350) 18 col.

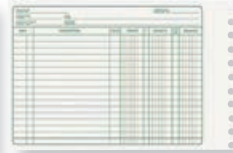

**G**  **Blueline®**

## F A1750 Accounting Book

Hard cover with glued binding. Green paper with green and brown  
ruling. 8-1/4 x 5-5/8". 100 numbered pages. 50% recycled content,  
50% post-consumer waste. FSC® Certified.

**BLI A1750-01** (215376) record

**BLIA1750-03** (1644) 3 col.

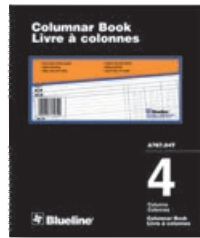

**H**  **Blueline®**

## G Sheet Refill for Ledger Kit

For B055 (17897) ledger. Debit-Credit-Balance. 50% recycled content,  
50% post-consumer waste. 5-1/2 x 8-1/2". Package of 100.

**BLI B55** (488429)

## H A767 Columnar Book

Recycled white paper. Tear off column-heads. Soft cover with  
double wire binding. Numbered lines and columns. Red and blue  
ruling. 80 pages. 12 x 10". 50% recycled content, 50% post-consumer  
waste. FSC® Certified.

**BLI A767-04T** (303842) 4 col.

**BLI A767-06T** (303867) 6 col.

**BLI A767-08T** (303875) 8 col.

**BLI A767-12T** (303891) 12 col.

**BLI A767-16T** (303917) 16 col.

**BLI A767-18T** (303925) 18 col.

**BLI A767-20T** (303933) 20 col.

## I A5200 Analysis Pad

Glued binding with soft cover. Side punched. Green paper with  
green and brown ruling. Numbered lines and columns. 50 sheets.  
10-7/8 x 8-1/2". 50% recycled content, 50% post-consumer waste.  
FSC® certified.

**BLI A5203** (215665) 3 col.

**BLI A5204** (16873) 4 col.

## J A5300 Columnar Pad

Soft cover with glued binding. Green paper. Green and brown ruling.  
Numbered lines and columns. 50 sheets. 8-1/4 x 14". 50% recycled  
content, 50% post-consumer waste. FSC® Certified.

**BLI A5304** (215707) 4 col.

**BLI A5307** (215731) 7 col.

**BLI A5308** (215749) 8 col.

**BLI A5314** (215772) 14 col.



**J**  **Blueline®**

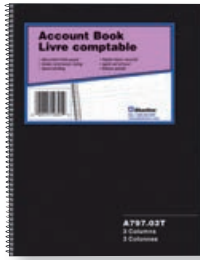

**A**  **Blueline®**



**B**  **Blueline®**

**A A797 Account Book**

Flexible cover. 3 columns. Spiral binding. Numbered lines and columns. 10-1/4 x 7-7/8". 100 pages. 50% recycled content, 50% post-consumer waste.  
**BLI A797-03T** (11064)

**B A-1650 Accounting Book**

Flexible cover with spiral binding. White paper with green and brown ruling. Size 8 x 5". 80 numbered pages. 3 columns with description. Numbered lines.  
**BLI A1650-03T** (11676)

**C Dean/Lefebvre Payroll Statement**

3 x 8". 100 sheets. Detailed summary of earnings and deductions.  
**DET 81-201** (214353) Bilingual  
**DET 81-200** (13565) English

**D Time Sheets**

Booklet of 100 individual time sheets. 1 carbon copy. 5-3/8 x 8 in.  
**BLI DB229** (216580) bilingual

**E Dean/Lefebvre Payroll Book**

One page/employee. Complete record of weekly and monthly wages. Detailed monthly statement of deductions. Record of employees for quick reference.

**4 employees**  
**DET95-104** (335356) Bilingual  
**DET95-004** (335364) English

**8 employees**  
**DET 80-108** (13524) Bilingual  
**DET 80-008** (1347) English

**16 employees**  
**DET 80-116** (13532) Bilingual  
**DET 80-016** (214320) English

**24 employees**  
**DET80-124** (1354) Bilingual  
**DET 80-024** (214338) English

**50 employees**  
**DET 80-150** (13557) Bilingual  
**DET 80-050** (214346) English

**F Employee Record Master File Jackets**

Front of jacket is printed in blue for basic employee information. Holds standard letter-size documents or smaller. 1.75 in expansion. Sealed on 3 sides to secure papers. 9-1/2 x 11-3/4 in. Package of 15. Manila.  
**TOP 32801** (1047521)

**G Car Operating Cost Record**

Yearly, bilingual. Pocket size.  
**DET 81-203** (214379)

**H Car Expense Record**

Blue flexible cover. 32 pages. 50% PCW recycled paper. 6-3/8 x 3-1/2". Bilingual.  
**BLI A295B** (215442)

**I Auto Expense Log Book - Deluxe Edition**

Flexible vinyl cover. 108 pages. 6-5/16" x 3-7/16". Bilingual. Black.  
**BLI A1580-BK** (242784)

**J Vehicle's Daily Inspection Report**

Carbonless. 2 copies. 31 days. In accordance with the National Safety Code (NSC), Standard 13, Schedule 1. Bilingual. 5-3/8 x 8".  
**BLI DCB252** (620906)



**C** 



**D**  **Blueline®**



**E** 

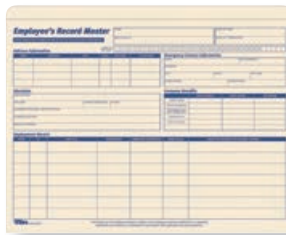

**F** 



**G** 

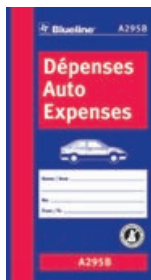

**H**  **Blueline®**



**I**  **Blueline®**

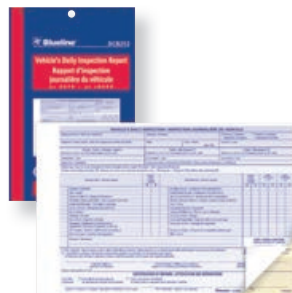

**J**  **Blueline®**

## A Restaurant Invoices

Numbered invoices. Tax chart on back. Booklet of 100.  
3-3/8 x 7-1/2". 1 copy. With stub. Bilingual.  
BLI GAFA (244301)



**A**  **Blueline®**

## B Receipt Booklet

2-3/4 x 6-3/4 in. - 50 receipts - 2 copies  
BLI DCB2870 (252056) Bilingual  
11 x 6-3/4 in. - 100 receipts - 3 copies  
BLIDC2884 (280610) English  
10-7/8 x 6-3/4 in. - 140 receipts - 2 copies  
BLI DC2874B (529560) bilingual



**B**  **Blueline®**



## C Security Receipts

Carbonless numbered receipts with space for description. 2 copies.  
50 receipts. 2-3/4 x 8 in.  
BLI DCB76 (311118) Bilingual  
200 receipts. 10-7/8 x 8 in.  
BLI DCB79 (311126) Bilingual

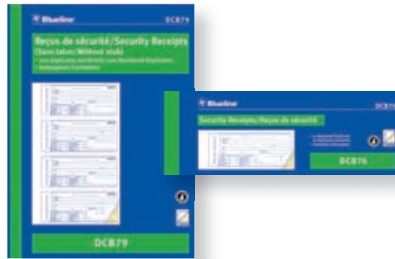

**C**  **Blueline®**



## D Receipt Book

Soft cover with spiral binding. 4 receipts per page. Carbonless.  
10-5/8 x 6-5/8 in. Bilingual.  
Not numbered, 200 receipts, 2 copies.  
BLI DCB4074T (252072)  
Numbered, 200 receipts, 2 copies.  
BLI A4074BT (434316)  
Numbered, 100 receipts, 3 copies.  
BLI DC4084BT (624585)



**D**  **Blueline®**



## E Numbered Receipt Book

Hard cover book with glued binding. Carbonless. 4 receipts per page.  
Bilingual. 10-3/4 x 8-1/4"  
400 receipts. 2 copies.  
BLI A3074B (11718)  
200 receipts. 3 copies.  
BLI A3084B (12047)



**E**  **Blueline®**

## F General Purpose Receipt Book

Carbonless duplicates (white, yellow). Bilingual. 200 sheets. 2.75 x 7.12 in.  
ABF ADC273B (528232) 50 receipts  
ABF ADC71B (1047679) 200 receipts



**F**  **adams™**

## G Delivery Receipts

Booklet of 50. 4-1/4 x 7". Duplicate. Carbonless. Bilingual.  
BLI DCB56 (254763)



**G**  **Blueline®**



## H Money Receipt Book

Convenient circles with preprinted designations of cash, check and money order. 4 forms per page. 3-part carbonless; White originals, Canary duplicates and Pink triplicates. 100 receipts. English.  
ABF TC1182 (1047737)



**H**  **adams™**

## I Invoice Book

Booklet of 50. Carbonless.  
5-3/8 x 8 in.  
BLI DCB36 (232710) duplicate (Bilingual)  
BLI DC31 (421693) duplicate (English)  
5-3/8 x 8 in.  
BLIDCB37 (232728) triplicate (Bilingual)  
BLIDC32 (421701) triplicate (English)  
8-1/2 x 11 in.  
BLI DCB177 (677450) triplicate (Bilingual)



**I**  **Blueline®**



## J Statements

Booklet of 50. 5-3/8 x 8". Duplicate. Carbonless. Bilingual.  
BLI DCB106 (393108)



**J**  **Blueline®**





**A** **Blueline®**



**B** **Blueline®**



**C** **Blueline®**



**D** **adams™**



**E** **Blueline®**

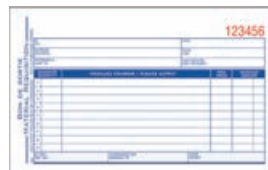

**F** **adams™**



**G** **Blueline®**



**H** **TOPS PRODUCTS**



**I** **Blueline®**

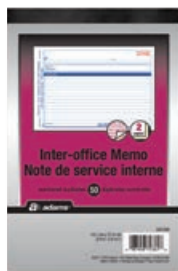

**J** **adams™**

**A Sales Book**

Numbered invoices. Booklet of 50. 3-1/2 x 6-1/2". Carbonless. 2 copies.

**Sold by each**

**BLI G3NCR2B** (133900) Bilingual

**BLI G3NCR2** (421800) English

**Package of 10**

**BLI G3NCR10B** (547315) Bilingual

**B Sales Orders**

Booklet of 50. Carbonless.

**3-1/2 x 6-1/2 in.**

**BLIDCB46** (254748) duplicate (bilingual)

**BLIDC41** (529503) duplicate (English)

**BLI DCB47** (254755) triplicate (bilingual)

**BLI DC42** (529511) triplicate (English)

**5-3/8 x 8 in.**

**BLI DCB26** (232694) duplicate (bilingual)

**BLI DC21** (421669) duplicate (English)

**BLI DCB27** (232702) triplicate (bilingual)

**BLI DC22** (421677) triplicate (English)

**8-1/2 x 11 in.**

**BLIDCB156** (232769) duplicate (bilingual)

**BLI DCB157** (232777) triplicate (bilingual)

**C Purchase Orders**

Booklet of 50. Carbonless.

**5-3/8 x 8 in.**

**BLI DCB66** (232736) duplicate (bilingual)

**BLIDC61** (421743) duplicate (English)

**BLI DCB67** (232744) triplicate (bilingual)

**BLI DC62** (421750) triplicate (English)

**8-1/2 x 11 in.**

**BLI DCB68** (232751) triplicate (bilingual)

**BLI DC63** (421768) triplicate (English)

**D Purchase Order Book**

50 carbonless receipts. Consecutively numbered. Space at top for corporate stamp. 5-9/16 x 8-7/16 in. Bilingual.

**ABF ADC53B** (532937) 2-part

**ABF ATC53B** (1047661) 3-part

**E Requisitions**

Booklet of 50. 4-1/4 x 7 in. Duplicate. Carbonless. Bilingual.

**BLI DCB16** (254730)

**F Material Requisition Forms**

Numbered. Carbonless duplicates (yellow and white). 50 sheets. 4.5 x 7 in. Bilingual

**ABF ADC48B** (1047646)

**G Numbered Repair Orders**

Package of 50. 3 copies. Carbonless. 8-1/2 x 11". Bilingual.

**BLI DB4811** (132704)

**H Job Work Order Forms**

Includes space for costs in materials and labour. 3-part carbonless (white, canary, white tag paper sequence). 5-1/2 x 9-1/8 in.

Package of 50.

**TOP 3868** (1047555)

**I Inter-Office Memos**

Box of 250. Carbonless. Triplicate. Bilingual. Numbered. 8-1/2 x 8".

**BLI A20B** (11189)

**J Inter-Office Memo Book**

2-part carbon less. 5-9/16 x 8-7/16 in. Bilingual. 50 memos.

**ABF ADC59B** (532945)



## A Corporation's Records

Black hard cover record book. Push-button mechanism. 8-1/2 x 11" sheets with 2-hole punched of 3/8" diameter. Complete set with share certificates.

### Federal - Livre de société par actions

ECX FF-5905 (236349)

### Quebec - Livre de la société par actions

ECX QF-5905 (224592)

#### • Exterior post

ECX Z-1600 (473264) 1/2 in.

ECX Z-1600-1 (473272) 1 in.

#### • Package of 100 additional white sheets

ECX Z-1740H (103606) 8-1/2 x 11 in.

ECX Z-1750H (303768) 9-1/2 x 11 in.



**A**



**B**

## B Corporate Record According to the Quebec Business Corporation Act

Black 3-ring binder with sleeve. 1-1/2 in. rings. For laser printers. 8-1/2 x 11" sheets with 3-hole punched. Complete with share certificates.

### Quebec - Livre de la société par actions Québec

ECX QF-5905-1 (303677) French

### Quebec - Corporation's Records Québec

ECX QA-5905-1 (303685) english

#### • Package of 100 refill sheets

ECX Z-1741H (303719)



**C**

## C Minutes Register - Legal Size

Hard black cover. With 100 blank sheets and 3 rectangular perforations.

ECX 6028 (303628)

#### • Package of 100 refill sheets

ECX Z-1770H (303636)

**D**

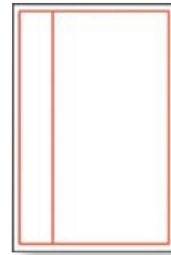

## D Notarial Paper

24 lb. Box of 500 sheets.

#### For originals

ECX Z-1788 (489757) legal size

#### For registration (old ruling)

ECX Z-1793 (489443) legal size

#### For registration (new ruling)

ECX Z-1790 (489732) legal size

#### Front and back ruling

ECX Z-1797 (645705) letter size

#### Prestige Official Notary

ECX Z1785 (369868) legal size



**E**

## E Share Certificate

With slip. For laser printers. Package of 10.

#### For laser printer - blank

ECX BL-5942-1 (303503) blue

ECX VE-5942-1 (303529) green

#### Incorporated under the Canada Business Corporation Act

ECX FFBL-59301 (303602) blue

#### Incorporated under the Companies Act of Quebec

ECX QFBL-59301 (303644) blue

ECX QFVE-59301 (303669) green

**F**

**Blueline®**



## F Document Corners

2 x 2". Light blue. Package of 100.

BLI A100-BL (205989)



**G**

**St. James**  
PAPER COMPANY

## G Self-Adhesive Printable Seals

11 x 8.5 in. sheets 1-3/4 in. seals. For laser or inkjet printer. Metallic gold.

Package of 200.

FST 83430 (553404)

**H**



## H Self-Adhesive Notary Seals

2-3/6 in. Roll of 500.

ECX A19002 (597583) silver

ECX O19002 (597591) gold

ECX R19002 (597609) red

## I Self-Adhesive Legal Seals

Permanent adhesive. 1-15/16 in. diameter. Package of 60.

AVE 2353 (594788) gold

AVE 2354 (594796) red



**I**

**AVERY**

Find Litigation Tabs  
on **page 519**

# File Folder Selector Guide

## Hanging File Folders

- Most convenient way to hold information in a file drawer.
- Best to leave in the file drawer.
- Use removable interior file folders inside hanging file folders.

## Box Bottom Hanging File Folders

- Expand at fold for storage of bulky records such as catalogues, large reports and printouts.

## Interior File Folders

- Ideal for keeping groups of papers separated within hanging file folders.

## Fastener Folders

- Perfect for keeping paperwork secure and in sequential order.

## Classification Folders

- Dividers inside folders allow separation of information into different subcategories.
- Fasteners keep papers secure and in sequential order.

## Expanding Pocket and Wallet Folders

- Provide ample space for larger amounts of material.



## Top-Tab File Folders

- Good for keeping titles visible for quick and simple reference.
- Also ideal for desktop organizers and for storing "low active" archived files in storage boxes.

## End-Tab File Folders

- Let you store files on shelves with all indexing visible, for quick filing and retrieval.
- Commonly utilized in the health care industry.



## Colour-Coding

- Use different colour folders or tabs for each section of files.
- Makes it easier to quickly find folders and put them back in the right place.
- Try using colours to show importance: red for immediate attention, yellow for current files, green for background material.

## Straight Cut Filing Tabs

- Run full width of file folder.
- Often used for multiple labels or extra-long headings.

## Half-Cut Filing Tabs

- Run half the width of the file folder.
- Staggered in sets of two for visibility.
- Good for long headings.

## Third Cut Filing Tabs

- Run a third the width of the file folder.
- Staggered in sets of three for visibility.

## Fifth Cut Filing Tabs

- Run a fifth the width of the file folder.
- Staggered in sets of five for visibility.
- Ideal for numerical or alphabetical indexing.

## Materials

- **Manila:** Thick, durable buff-coloured paper originally made from Manila hemp fibre. Provides tearing, folding and bursting strength at a popular price.
- **Kraft:** Strong, unbleached sulphate stock with a smooth surface and pleasing tan colour. Good for applications that require strength and rigidity.
- **Pressboard:** Stiff, durable, highly glazed paperboard stock of superior rigidity and strength. Made from rag or chemical wood pulp to be less acidic than board made from mechanical wood pulp.
- **Polypropylene:** Durable and flexible. Tear-resistant, static-free, acid-free, archival quality, protects against copy transfer.

## Archival Safe Folders

- Made of lignin and acid-free stock to provide superior protection for archival storage of documents and photographs.

## Anti-Microbial Folders

- Especially treated with anti-microbial agent to guard against growth of bacteria, odours, algae, mould, fungus and mildew. Ideal for medical environments or anywhere bacteria and mould control is critical.

## Point System

- 9 1/2 pt: Medium weight manila for inactive files.
- 11 pt: Heavy-weight stock is the economical choice for general filing.
- 14 pt: Extra heavy-weight durable folder stock for files that get frequent use.
- 17 pt: Super heavy-weight. Common weight for guides.
- 20–25 pt: Superior weight and rigidity available in pressboard.

## Suggestions

- Alphabetical organization usually works better than a complex system.
- Start with broad categories, then divide into smaller subcategories.
- Put noun first, then adjective "clients, past" not "past clients."
- Avoid vague categories such as "miscellaneous" or "other."
- Combine folders that go together under one larger heading.
- Split larger categories into smaller ones as folders get too stuffed
- Abandon categories or add new ones as situations change.
- Spell out acronyms and abbreviations.
- Use markers to show when a file has been removed, and by whom. Make an index of all your files to help eliminate overlapping or conflicting file names.

**Pendaflex®**



# Divide and conquer projects

with Pendaflex Divide It Up™  
Multi-Section File Folders



**Categorize papers with  
three sections in one folder.**

**i** All file folders on this page are made in Canada and contain a percentage of post-consumer recycled fibre.

**A** **Pendaflex®**



**A Straight Cut File Folders**

10-1/2-pt. Straight cut tab. Box of 100. Ivory. 10% post-consumer fibre.  
**PFX 413S** (485797) letter  
**PFX 613S** (485698) legal

**B Straight Cut File Folders**

9-1/2-pt. Straight cut tab. Box of 100. Manila. 10% post-consumer fibre.  
**PFX 409SC** (485888) letter  
**PFX 609SC** (485870) legal

**C Straight Cut File Folders**

10-1/2-pt. Straight cut tab. Box of 100. Natural. 60% post-consumer fibre.  
**PFX 412SC** (387662) letter  
**PFX 612SC** (220103) legal



**B** **Pendaflex®**



**C** **Pendaflex®**



**D Reversible File Folders**

1/2 cut tab durable covers for extra strength. Box of 100. Ivory. 10% post-consumer fibre.  
**9-1/2-pt.**  
**PFX R411** (486035) letter  
**PFX R611** (486027) legal  
**10-1/2-pt.**  
**PFX R413** (658286) letter  
**PFX R613** (658294) legal

**E Reversible File Folders**

1/2-cut tab durable covers for extra strength. Box of 100. Manila. 10% post-consumer fibre.  
**9-1/2-pt.**  
**PFX R409** (486019) letter  
**PFX R609** (486001) legal  
**13-1/2-pt.**  
**PFX R414** (485995) letter  
**PFXR614** (485987) legal

**F Reversible File Folders**

10-1/2-pt. 1/2-cut tab durable covers for extra strength. Box of 100. Natural. 60% post-consumer fibre.  
**PFX R412** (486290) letter  
**PFX R612** (486282) legal

**G Reversible File Folders**

9-1/2-pt stock. 1/2-cut printed tab. Scored for 3/4 in. expansion. Package of 10. Manila. 10% post-consumer fibre.  
**PFX E10138** (351551) letter  
**PFX E15138** (351569) legal



**D** **Pendaflex®**



**E** **Pendaflex®**



**F** **Pendaflex®**



**G** **Pendaflex®**



**H Enviro-Plus File Folders**

9-1/2-pt. 1/2-cut printed tab. Sand. Package of 100. 100% recycled content, 60% post-consumer.  
**HLR 55074** (126904) letter  
**HLR 65002** (126920) legal

**I Offix® Reversible File Folders**

9-1/2-pt. 1/2-cut printed tab. Box of 100. Manila.  
**NVX 345363** (345363) letter  
**NVX 345371** (345371) legal



**H** **Enviro Plus®**



**I** **offix®**



Find File Folder Labels on **page 463**



## A File Folders With Double-Reinforced Tab

9-1/2-pt. 1/2-cut right printed tab. Reinforced across the tab and top edge. Box of 100. Ivory. 60% post-consumer content.  
**PFX IDT411-RT** (485938) letter  
**PFX IDT611-RT** (485946) legal



**A** **Pendaflex®**



**B** **Hilroy**

## B File Folders

10-1/2-pt. 1/2-cut printed tab. Box of 100. Ivory. 10% recycled content.  
**HLR 55269** (231456) letter  
**HLR 65269** (231597) legal

## C Double Stuff File Folders

400 sheet capacity. 1/2-cut tab. 1-1/2 in. expansion. Letter size.  
 Package of 24. Manila.  
**PFX 77000** (1026236)

## D Pressboard File Folder

25-pt pressboard. Reinforced tape gusset with 1 in. expansion.  
 Light green. 60% recycled fibre; 30% post-consumer fibre.  
**Straight cut tab (sold by each)**  
**PFXP421-S** (631341) letter  
**PFXP621-S** (436519) legal  
**1/2-cut right tab (box of 50)**  
**PFX P421-RT** (277087) letter  
**PFX P621-RT** (277095) legal



**C** **Pendaflex®**



**D** **Pendaflex®**



## E Interior File Folders

9-1/2-pt. Straight cut tab. To separate documents inside hanging folders.  
 Box of 100. Ivory. 10% post-consumer content.  
**PFX 41711S-IVY** (485920) letter  
**PFX 61711S-IVY** (485912) legal

## F Interior File Folders

11-pt. 1/3-cut tab in assorted positions. Sized to fit inside hanging folders, pockets or expanding files. Box of 100. Manila.  
 10% post-consumer content.  
**BSN 65775** (803809) letter  
**BSN 43560** (803783) legal

Use with hanging file folders



**E** **Pendaflex®**

Use with hanging file folders



**F** **B BUSINESS SOURCE®**

## G File Folders

11-pt. Box of 100. Manila. 10% post-consumer fibre.

### Letter size

**BSN43565** (1026921) straight cut tab  
**BSN16490** (803874) 1/3-cut tab - left  
**BSN16491** (803882) 1/3-cut tab - center  
**BSN16492** (803890) 1/3-cut tab - right  
**BSN17524** (1027010) 1/2-cut tab - assorted positions  
**BSN17525** (1026426) 1/3-cut tab - assorted positions

### Legal size

**BSN43566** (803908) straight cut tab  
**BSN99724** (1026848) 1/3-cut tab - left  
**BSN99725** (1026856) 1/3-cut tab - center  
**BSN99723** (1026863) 1/3-cut tab - right  
**BSN 17526** (1026418) 1/3-cut tab - assorted positions

## H Offix® Reversible File Folders

10-1/2-pt. 1/2-cut, printed tab. Natural Kraft. 100% recycled fibre.

### Box of 100

**NVX 345603** (345603) letter  
**NVX 345611** (345611) legal

### Box of 200

**NVX 345629** (345629) letter  
**NVX 345637** (345637) legal



**G** **B BUSINESS SOURCE®**



**H** **offix®**

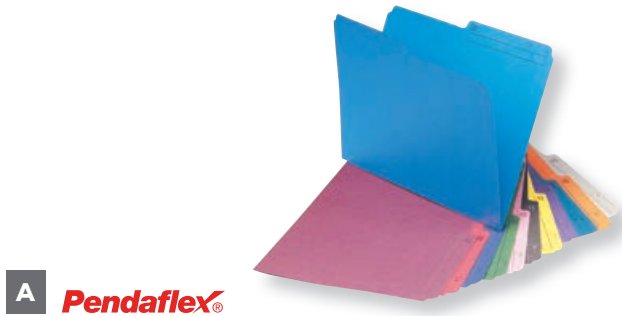

**A** **Pendaflex®**



**A Reversible Coloured File Folders**

10-1/2-pt. 1/2-cut tab. Box of 100.  
10% post-consumer fibre.

**Letter size**

- PFX R415-RED** (486241) red
- PFX R415-YLW** (486191) yellow
- PFX R415-BLU** (486167) blue
- PFX R415-BUR** (486175) burgundy
- PFX R415-GRN** (486266) green
- PFX R415-GRY** (486183) grey
- PFX R415-NAV** (486209) navy
- PFX R415-ORG** (486225) orange
- PFX R415-PNK** (486233) pink
- PFX R415-TEA** (486258) teal
- PFX R415-VIO** (486274) violet
- PFX R415-BLK** (486217) black

**Legal size**

- PFXR615-BLU** (486043) blue
- PFX R615-BUR** (486050) burgundy
- PFX R615-GRN** (486142) green
- PFX R615-GRY** (486068) grey
- PFX R615-NAV** (486084) navy
- PFX R615-ORG** (486100) orange
- PFX R615-PNK** (486118) pink
- PFX R615-RED** (486126) red
- PFX R615-TEA** (486134) teal
- PFX R615-VIO** (486159) violet
- PFX R615-YLW** (486076) yellow
- PFX R615-BLK** (486092) black



**B** **Pendaflex®**



**B Coloured File Folders**

10-1/2-pt. Straight-cut tab. Box of 100.  
10% post-consumer fibre.

**Letter size**

- PFX415S-BLU** (485771) blue
- PFX 415S-GRN** (485854) green
- PFX 415S-RED** (485847) red
- PFX 415S-YLW** (485805) yellow

**Legal size**

- PFX 615S-BLU** (485672) blue
- PFX 615S-GRN** (485755) green
- PFX 615S-RED** (485748) red
- PFX 615S-YLW** (485706) yellow



**C** **Pendaflex®**



**D** **ENVIRO PLUS®**



**C Coloured Reversible File Folders**

1/2-cut tab. Assorted colours.

9-1/2-pt. - **package of 10**

**PFX DCP415-10** (669820) letter

11-pt. - **package of 25**

**PFX R415-25AST** (351593) letter

**PFX R615-25AST** (351601) legal



**E** **SMEAD®**



**D Enviro-Plus File Folders**

9-1/2-pt. 1/2-cut tab. Package of 40. Assorted colours.

100% recycled content, 60% post-consumer.

**HLR 55070** (126896) letter

**HLR 65000** (126912) legal



**F** **B BUSINESS SOURCE®**



**E SuperTab® Reversible File Folders**

11-pt. 1/2-cut tab. Large labelling area,

7/8 in. high tab. Box of 100. Assorted colours.

10% post-consumer fibre.

**SMD 11906** (772509) letter

**SMD 15906** (772541) legal

**F Coloured File Folders**

11-pt. 1/3-cut tab in assorted positions. Box of 100.

10% post-consumer fibre.

**Letter size**

- BSN65780** (803866) assorted colours
- BSN 44105** (803817) orange
- BSN65776** (803826) red
- BSN 65777** (803833) green
- BSN 65778** (803841) yellow
- BSN 65779** (803858) blue

**Legal size**

- BSN65781** (1026988) assorted colours
- BSN 99719** (1026806) blue
- BSN 99720** (1026822) red
- BSN99721** (1026814) green
- BSN99722** (1026830) yellow

## A Twisted Glow File Folders

11-pt. 1/2-cut tab. Alternating colours. Letter size. Package of 24. Assorted neon colours. 10% post-consumer fibre. PFX 67100 (581942)

## B Glow File Folders

11-pt. 1/2-cut tab. Alternating colours. Letter size. Package of 24. Assorted neon colours. 10% post-consumer fibre. PFX 57100 (1025965)

## C Divide It Up™ File Folders

11-pt. Multi-section file folder with 4 tabs. Letter size. Box of 24. PFX 10770 (566463) manila  
PFX 10772 (163725) assorted colours

## D Offix® Reversible Coloured File Folders

10-1/2-pt. 1/2-cut printed tab. Box of 100. 10% post-consumer fibre.

### Letter size

NVX 345389 (345389) red  
NVX 345397 (345397) blue  
NVX 345405 (345405) green  
NVX 345413 (345413) pink  
NVX 345421 (345421) orange  
NVX 345439 (345439) yellow

### Legal size

NVX 345447 (345447) red  
NVX 345454 (345454) blue  
NVX 345462 (345462) green  
NVX 345470 (345470) pink  
NVX 345488 (345488) orange  
NVX 345496 (345496) yellow  
NVX 345504 (345504) purple  
NVX 345512 (345512) grey  
NVX 345520 (345520) teal  
NVX 345538 (345538) burgundy  
NVX 345546 (345546) navy

## E SuperTab® File Folders Organizer

11-pt. Oversized 1/3-cut tab. Dividers create individual sections with a larger file. Each section expands to 3/4" for extra capacity. Letter size. Assorted colours. Package of 3. SMD 11989 (279315)

## F File Folders

1/2-cut tab. Made from ultra-durable, waterproof, reusable polypropylene. Labels included. Package of 12.

### Letter size

VLB37200 (696062) assorted colours  
VLB 37211 (711911) blue  
VLB 37212 (711929) red  
VLB 37215 (711937) green  
VLB 37216 (711945) yellow

### Legal size

VLB37100 (696070) assorted colours  
VLB37111 (567362)  
VLB 37112 (711960) red  
VLB 37115 (711978) green  
VLB 37116 (711986) yellow

## G Slimtrim™ Fastener Folders

10-1/2-pt. 1/2-cut right tab. 2 in. capacity fastener. Ivory. Box of 100. 10% post-consumer fibre. PFX STR413-RT (485615) letter  
PFX STR613-RT (485607) legal

## H Self-Adhesive Folder Dividers

Add subdivision to any file. Peel back the protective strip and press the adhesive-hinged flap into any folder. Letter size. Box of 100. 10% post-consumer content. SMD 68021 (441436)



A

**Pendaflex®**



B

**Pendaflex®**



C

**Pendaflex®**



D

**offix®**



Polypropylene



E

**SMEAD®**

F

**vlb**



Integrated fastener

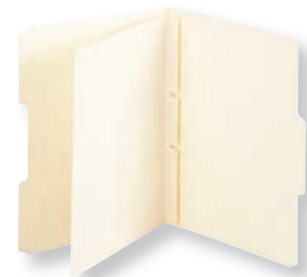

G

**Pendaflex®**



H

**SMEAD®**





**A** **Pendaflex®** 



**C** **Pendaflex®** 



**E** **SMEAD®** 



**H** **Pendaflex®** 

**H Classification Folders**

Expandable reinforced gusset. 25-pt pressboard covers, 17-pt kraft dividers. 6 fasteners. Box of 10. Cover: 60% recycled content; 30% post consumer fiber. Divider: 10% recycled content; 10% post consumer fiber.

- Letter size**  
**PFX 24132P** (829283) blue  
**PFX 24131P** (829285) red  
**PFX 24133P** (829284) green  
**Legal size**  
**PFX 29035P** (829286) blue  
**PFX 29031P** (829288) red  
**PFX 29033P** (829287) green



**B** **Pendaflex®** 



**D** **naturesaver®**  



**F** **Pendaflex®** 



**G** **naturesaver®**  

**G Classification Folders With Fasteners**

25-pt covers with 2 fasteners. Box of 10. 100% recycled content, 30% post-consumer.

- Letter size, 1 divider**  
**NAT SP17200** (1026054) blue  
**NAT SP17201** (1026079) red  
**NATSP17203** (1026061) green  
**NAT SP17204** (1026087) yellow  
**Letter size, 2 dividers**  
**NAT SP17205** (1026137) blue  
**NAT SP17206** (1026160) red  
**NATSP17207** (1026145) dark blue  
**NAT SP17208** (1026153) green  
**NAT SP17209** (1026178) yellow  
**Legal size, 1 divider**  
**NAT SP17219** (1026955) blue  
**NAT SP17222** (1026970) green  
**NAT SP17221** (1026962) dark blue  
**Legal size, 2 dividers**  
**NATSP17224** (1026095) blue  
**NAT SP17225** (1026111) red  
**NATSP17226** (1026103) green  
**NATSP17227** (1026129) yellow  
**NATSP17228** (1026004) dark blue

**A Classification Folder**

25-pt green pressboard cover. 2 10-1/2-pt dividers, 6 fasteners. 10% (dividers), 30% (covers) post-consumer fibre.  
**PFX P43-6** (220046) letter  
**PFX P63-6** (220053) legal

**B Classification Folder**

Expandable reinforced gusset. 25-pt pressboard covers, 17-pt kraft dividers. 2 in. expansion. Letter size. Extra long tab. Cover: 65% recycled content; 30% post consumer fiber. Divider: 10% recycled content; 10% post consumer fiber. Green.  
**PFX E17173** (351239) 6 fasteners  
**PFX E17174** (351247) 8 fasteners

**C Classification Folder**

Manilla 17 pts stock. 2 dividers with 6 fasteners. 2 in. expandable reinforced taped gusset. 10% (dividers), 30% (covers) post-consumer fibre.  
**PFX 03252** (772970) letter  
**PFX 03352** (772988) legal

**D Classification Folders**

Expandable reinforced gusset. 25-pt pressboard, 20-pt kraft dividers. 2/5-cut tab. 2 in. fasteners on covers, 1 in. fasteners on dividers. Folders with 1 or 2 dividers have a 2 in. expansion, folders with 3 dividers have a 3 in. expansion. Box of 10. 100% recycled content; 30% post consumer.

- Letter size**  
**NAT 01050** (1026210) 1 divider - red  
**NAT 01051** (1026228) 2 dividers - red  
**NAT01057** (1026749) 2 dividers - grey/green  
**NAT 01058** (1026757) 3 dividers - grey/green  
**Legal size**  
**NAT 01053** (1026186) 1 divider - red  
**NAT 01054** (1026194) 2 dividers - red  
**NAT39951** (1025767) 2 dividers - grey  
**NAT 01055** (1026202) 3 dividers - red

**E Classification Folder**

25-pt stock (dividers: 17 pt). Dividers with 1 in. prong fastener on both sides. Grey/green. 60% recycled content, 30% post-consumer waste.

- Sold by each - 3 dividers, 3 in expansion, 2/5-cut right tab**  
**SMD 14091** (119677) letter  
**SMD 19091** (119776) legal  
**Box of 10 - 2 dividers, 2 in. expansion, 1/3-cut right tab**  
**SMD14215** (365817) letter  
**SMD19215** (365288) legal

**F Classification Folder**

Expandable reinforced gusset. 25-pt pressboard covers, 17-pt kraft dividers. Extra long tab. Acid free. Cover: 65% recycled content; 30% post consumer fiber. Divider: 10% recycled content; 10% post consumer fiber.

- 6 fasteners. 2-1/2 in. expansion. Letter size.**  
**PFX E24075R** (351254) red  
**PFXE24030R** (351270) blue  
**PFX E24076R** (351262) green  
**6 fasteners. 2-1/2 in. expansion. Legal size.**  
**PFX E29030R** (351320) blue  
**PFX E29075R** (351312) red  
**PFXE29076R** (351304) green  
**8 fasteners. 3-1/2 in. expansion. Legal size.**  
**PFX E29091R** (351288) green



## A File Guides

Green pressboard. 25 pts. A to Z. 60% recycled fibre, 30% post-consumer fibre.  
**PFX P425U** (154237) letter  
**PFX P625U** (154245) legal  
**Reinforced tabs**  
**PFX PC625U** (224816) legal



## B Self-Adhesive File Folder Labels

Permanent adhesive. For 1/3-cut tab. 3-7/16 x 2/3 in. Package of 70.  
**AVE 2329** (594689) assorted colours  
**AVE 2325** (594705) blue  
**AVE 2326** (594713) red  
**AVE 2327** (594697) white  
**AVE 2328** (594663) green

## C Removable White Filing Labels

For ink jet and laser printers. 3-7/16 x 2/3 in. No border. Package of 300 labels - 10 sheets.  
**AVE 06505** (479261)

## D TrueBlock™ Filing Labels

For ink jet and laser printers. Permanent adhesive. New TrueBlock™ technology covers everything underneath. 3-7/16 x 2/3 in. With colour border. FSC® Certified.  
**Package of 300 labels - 10 sheets**  
**AVE 15266** (188409) assorted colours  
**Package of 600 labels - 20 sheets**  
**AVE 05266** (187500) assorted colours  
**AVE 05066** (286393) red  
**AVE05366** (286385) white  
**AVE 05766** (286401) blue  
**AVE05866** (286419) green  
**AVE 05966** (286427) yellow  
**Box of 1500 labels - 50 sheets**  
**AVE 05566** (479253) white



## E TrueBlock™ Extra Large Filing Labels

For ink jet and laser printers. Permanent adhesive. Covers everything underneath. 3-7/16 x 15/16 in. Package of 360 labels - 20 sheets. FSC® Certified.  
**AVE 35027** (697771)

## F Block-Out File Folder Labels

For laser and inkjet printers. Permanent adhesive. Smudge-free. Jam-free. Completely opaque. 3-7/16 x 2/3 in. Package of 750 labels - 25 sheets.  
**BSN 26137** (1029016)

## G Filing Labels

For laser and inkjet printers. Permanent adhesive. Acid-free. 3-7/16 x 2/3 in.  
**BSN 26151** (1029040) 750 labels  
**BSN 26102** (1029081) 1500 labels



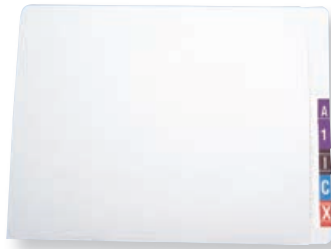

**A** **Pendaflex®**



**B** **Pendaflex®**

**A End Tab File Folder**

13-1/2-pt. Reinforced tabs provide extra durability. Box of 50. Ivory. 10% post-consumer fibre.  
**PFX A88GD-10** (411702) letter  
**PFX A98GD-10** (411710) legal

**B Laminated End Tab File Folder**

11-pt. Reinforced bottom score. Double-ply reinforced tab. Lifetime warranty. Manila. Box of 100. 10% post-consumer fibre.  
**PFX 11035** (624551) letter  
**PFX 11055** (624569) legal

**C End Tab File Folders**

2-ply tab provides extra durability. Ivory. Box of 100. 10% post-consumer fibre.  
**10-1/2-pt**  
**PFX 97260** (624510) letter  
**PFX 97360** (624528) legal  
**13-1/2-pt**  
**PFX 98260** (624536) letter  
**PFX 98360** (624544) legal

**D End Tab File Folders**

11-pt. 2-ply straight-cut tab. Manila. Box of 100. 10% post-consumer fibre.  
**PFX H110D** (485631) letter  
**PFX H210D** (485649) legal

**E End Tab File Folders**

Ivory. Single-ply tab. 10-1/2 pts. Box of 100. 10% post-consumer fibre.  
**Straight cut tab**  
**PFX 413EF** (624494) letter  
**PFX 613EF** (624502) legal  
**1/2 cut tab**  
**PFX 413E-IVR** (1025866) letter  
**PFX 613E-IVR** (1025833) legal

**F End Tab File Folder**

Reinforced, straight-cut tabs. 10% post-consumer fibre.  
**11-pt. - letter size (box of 100)**  
**PFX H110DBL** (785501) blue  
**PFX H110DGR** (788935) green  
**PFX H110DOR** (784074) orange  
**PFXH110DP** (1003011) Pink  
**PFXH110DPR** (1025958) purple  
**PFXH110DR** (785519) red  
**PFXH110DTQ** (528299) turquoise  
**PFXH110DY** (788927) yellow  
**13-1/2-pt - legal size (box of 50)**  
**PFXH210DBL** (783639) blue  
**PFXH210DGR** (783464) green  
**PFXH210DGY** (799338) grey  
**PFX H210DOR** (785683) orange  
**PFX H210DP** (785527) pink  
**PFXH210DPR** (595702) purple  
**PFX H210DR** (529750) red  
**PFX H210DTQ** (783621) turquoise  
**PFX H210DY** (566372) yellow

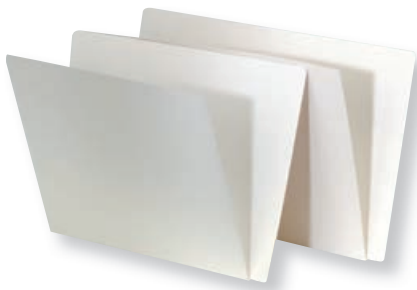

**C** **Pendaflex®**



**D** **Pendaflex®**



**E** **Pendaflex®**



**F** **Pendaflex®**

## A End Tab Fastener Folders

11-pt. Reinforced end tab. 2 in. bonded fastener in positions #1 and #3. Manila. Box of 50. 10% post-consumer fibre.  
**PFX H10U13** (493221) letter  
**PFX H20U13** (493239) legal



**A** **Pendaflex®**



**B** **Pendaflex®**



## B Pressboard End Tab Fastener Folder

25-pt pressboard cover. 17-pt kraft dividers. 2 in. expandable reinforced tape gusset. 2 dividers provide 6 filing sections. 6 fasteners. 10% (dividers); 30% (covers) post-consumer fibre.  
**PFX 23224** (493247) letter  
**PFX23324** (493254) legal

## C Shelf-Master® End Tab Fastener Folders

Reinforced straight-cut tab, 2 fasteners. Letter size. Box of 50. Manila. 10% post-consumer fibre.  
**SMD 34120** (597195)

## D End Tab Fastener Folders

11 pt. Straight cut. Reinforcement bottom. 2 in. bonded fastener in position #1. Box of 50. Manila. 10% post-consumer fibre.  
**PFX13140** (658328) letter  
**PFX 13210** (658336) legal



**C** **SMEAD®**



**D** **Pendaflex®**



## E End Tab Fastener Folders

11-pt. with fasteners in positions 1 and 3. Letter size. Box of 50. Contains 10% post-consumer material.  
**BSN 17242** (1026327) blue  
**BSN 17244** (1026335) green

## F End Tab File Jackets

11-pt. Reinforced straight-cut tab. Antimicrobial protection. Sealed on two sides. Front panel cut diagonally. Letter size. Box of 100. Manila.  
**SMD 75715** (575654)

## G Poly Retention Jackets

Add documents to fastener folders without punching them. Clear pockets adjust to fit either letter or legal size folders, expand to 3/4 in. and are die cut for easy access. Leave top flap folded for letter size documents or unfold flap to accommodate legal size materials. Package of 24.  
**SMD 68191** (365148)

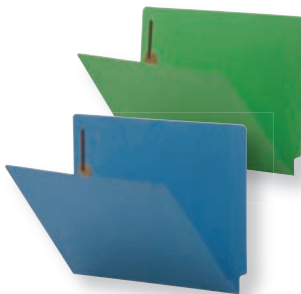

**E** **B BUSINESS SOURCE®**



**F** **SMEAD®**



## H End Tab Fastener Folders

11 pt. manila stock. 2 bonded 2" capacity fasteners. Reinforced bottom. 2-ply reinforced straight cut full tab. Letter size. Box of 250. 10% post-consumer fibre.  
**PFX 13160** (809368)

## I Pressboard File Folders with Fasteners

11-pt. 2 fasteners. Reinforced 2/5 cut. Tab right of center position. Box of 50. Kraft. 10% post-consumer fibre.  
**SMD 14880** (596312) letter  
**SMD19880** (809285) legal



**G** **SMEAD®**



**H** **Pendaflex®**



## J Classification Folder

18-pt. with 2 in. fasteners. Letter size. Box of 10. Manila. 10% post-consumer fibre.  
**BSN 17271** (1026038) 1 divider  
**BSN17223** (1026046) 2 dividers



**I** **SMEAD®**



**J** **B BUSINESS SOURCE®**





**A** **Pendaflex®**



**B** **Pendaflex®**



**C** **Pendaflex®**



**D** **Oxford™**



**E** **Pendaflex®**

**A Bilingual File Out Guide**

Clearly mark where a folder has been removed from the file by inserting an out guide in its place. 10% recycled material. Acid-free. Bilingual.  
**PFXE400** (566661) letter  
**PFX E600** (566679) legal

**B End Tab A-Z Filing Labels**

Compatible with DataFile L8701 series labels. 1-1/4 x 15/16 in.  
 Package of 240 (15 sheets of 16 labels).

- PFX 06601** (624106) A - orange
- PFX 06602** (624114) B - red
- PFX 06603** (624122) C - light orange
- PFX 06604** (624130) D - dark orange
- PFX 06605** (624148) E - yellow
- PFX 06606** (624155) F - light green
- PFX 06607** (624163) G - dark green
- PFX 06608** (624171) H - light blue
- PFX 06609** (624189) I - purple
- PFX 06610** (624197) J - lilac
- PFX 06611** (624205) K - brown
- PFX 06612** (624213) L - light brown
- PFX 06613** (624221) M - orange
- PFX 06614** (624239) Mc - pink
- PFX 06615** (624247) N - red
- PFX 06616** (624254) O - light orange
- PFX 06617** (624262) P - dark orange
- PFX 06618** (624270) Q - yellow
- PFX 06619** (624288) R - light green
- PFX 06620** (624296) S - dark green
- PFX 06621** (624304) T - light blue
- PFX 06622** (624312) U - purple
- PFX 06623** (624320) V - lilac
- PFX 06624** (624338) W - brown
- PFX 06625** (624346) X - light brown
- PFX 06626** (624353) Y - white/grey
- PFX 06627** (624361) Z - grey/white
- **Starter ket of 3840 labels**
- PFX 06600** (625327)

**C 0-9 End Tab Filing Labels**

Compatible with DataFile L8700 series labels. 1-1/4 x 15/16 in.  
 Roll of 500 labels.

- PFX 06630** (624379) 0 - pink
- PFX 06631** (624387) 1 - red
- PFX 06632** (624395) 2 - light orange
- PFX 06633** (624403) 3 - dark orange
- PFX 06634** (624411) 4 - light green
- PFX 06635** (624429) 5 - dark green
- PFX 06636** (624437) 6 - blue
- PFX 06637** (624445) 7 - purple
- PFX 06638** (624452) 8 - lilac
- PFX 06639** (624460) 9 - brown

**D 0-9 End Tab Filing Labels**

0-9 filing labels. Package of 500 labels per number.  
 1 1/4" Width x 15/16" Length

- PFX 06640** (625335)

**E End Tab Year Filing Labels**

Also compatible with Datafile® L8800 series labels. 1-1/4 x 15/16".  
 Roll of 500.

- PFX06722** (805946) 2022
- PFX 06723** (828882) 2023
- PFX06724** (831361) 2024

***Pendaflex***<sup>®</sup>

**You'll be hooked.**

**SureHook™ Hanging Folders**  
grip the rails with reinforced,  
spring-loaded hooks.



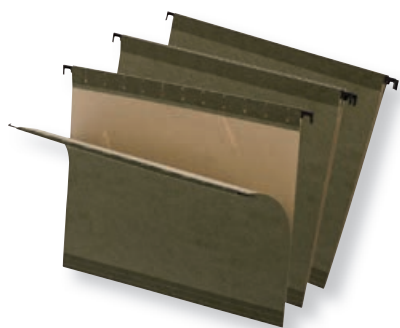

**A** **Pendaflex®**



**B** **Pendaflex®**



**A SureHook™ Reinforced Hanging File Folders**

Reinforced rod and flexible hook won't buckle under pressure. Folders stay on rails and slide with ease. Standard green. Box of 20. 10% recycled content, 10% post-consumer fibre.

**PFX 6152C** (120907) letter  
**PFX6153C** (120915) legal

**B SureHook™ Reinforced Hanging File Folders**

Reinforced rod and flexible hook won't buckle under pressure. Folders stay on rails and slide with ease. Box of 20. 10% recycled content, 10% post-consumer fibre.

**Letter size**  
**PFX6152CAS** (141283) assorted colours  
**PFX6152CBLU** (528166) blue  
**PFX 6152CRED** (594077) red  
**PFX 6152CYLW** (595710) yellow  
**PFX 6152CBGR** (1027226) green

**Legal size**  
**PFX 6153CAS** (141291) assorted colours  
**PFX6153CBLU** (224980) blue  
**PFX6153CRED** (225003) red  
**PFX6153CYLW** (225011) yellow  
**PFX6153CBGR** (224964) green  
**PFX 6153CORA** (544213) orange

**C Reversaflex® Hanging File Folders**

Reinforcement at upper and inner fold. 11-pt stock. Box of 25. Standard green. 10% post-consumer fibre.

**PFX 05152** (486910) letter  
**PFX 05153** (486787) legal



**C** **Pendaflex®**



**D** **Pendaflex®**



**D Reversaflex® Hanging File Folders**

Reinforcement at upper and inner fold. 11-pt stock. Box of 25. 10% post-consumer fibre.

**Letter size**  
**PFX 05152-BLU** (486829) blue  
**PFX 05152-BLK** (486860) black  
**PFX 05152-GRN** (486928) green  
**PFX 05152-GRY** (486845) grey  
**PFX 05152-NAV** (486852) navy  
**PFX 05152-ORG** (486878) orange  
**PFX 05152-PNK** (486886) pink  
**PFX 05152-RED** (486894) red  
**PFX 05152-TEA** (486902) teal  
**PFX 05152-VIO** (486936) purple  
**PFX 05152-YLW** (486811) yellow

**Legal size**  
**PFX 05153-BLU** (486688) blue  
**PFX 05153-BLK** (486738) black  
**PFX 05153-GRN** (486795) green  
**PFX 05153-GRY** (486704) grey  
**PFX 05153-NAV** (486720) navy  
**PFX 05153-ORG** (486746) orange  
**PFX 05153-PNK** (486753) pink  
**PFX 05153-RED** (486761) red  
**PFX 05153-TEA** (486779) teal  
**PFX 05153-VIO** (486803) purple  
**PFX 05153-YLW** (486712) yellow  
**PFX 05153-BUR** (486696) burgundy

**E ReadyTab® Lift Tab Reinforced Hanging Folders**

With Lift-Tab technology. Built-in tabs stay uniform and neatly aligned (5 for letter size, 6 for legal size). Lift tab in the location you desire, snap closed and apply label or write directly on tab. Box of 25. Standard green. 10% post-consumer fibre.

**PFX42590** (163790) letter  
**PFX 42591** (163808) legal



**E** **Pendaflex®**

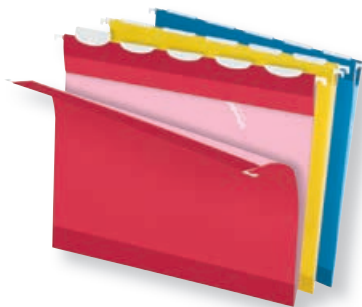

**F** **Pendaflex®**



**F ReadyTab® Lift Tab Reinforced Hanging Folders**

With Lift-Tab technology. Built-in tabs stay uniform and neatly aligned (5 for letter size, 6 for legal size). Lift tab in the location you desire, snap closed and apply label or write directly on tab. Box of 25. Assorted colours. 10% post-consumer fibre.

**PFX 42592** (163816) letter  
**PFX 42593** (163824) legal

## A EasyView Hanging Folders

Polypropylene. Resists wear, tear and moisture. Colour bar on top. Flexible tabs and inserts included. Letter size. Package of 10. 5 assorted colours.  
**PFX 55711C** (732545)



Polypropylene

## B Glow Hanging File Folders

11-pt. paper stock. Letter size. Package of 12. Assorted neon colours. 10% recycled content, 10% post-consumer waste.  
**PFX 81670** (581934)

## C Hanging File Folders

Coating hanging rods for smooth sliding. Lighter interior colour reduces filing errors. 11-pt stock. Box of 25. 10% post-consumer fibre.

### Letter size

- PFX 91803** (486506) blue
- PFX 91802** (486555) black
- PFX 91804** (486605) green
- PFX 91805** (486514) burgundy
- PFX 91806** (486522) grey
- PFX 91807** (486548) navy
- PFX 91808** (486563) orange
- PFX 91809** (486571) pink
- PFX 91810** (486589) red
- PFX 91811** (486597) teal
- PFX 91812** (486621) violet
- PFX 91813** (486530) yellow

### Legal size

- PFX 91833** (486365) blue
- PFX 91832** (486415) black
- PFX 91834** (486464) green
- PFX 91835** (486373) burgundy
- PFX 91836** (486381) grey
- PFX 91837** (486407) navy
- PFX 91838** (486423) orange
- PFX 91839** (486431) pink
- PFX 91840** (486449) red
- PFX 91841** (486456) teal
- PFX 91842** (486480) violet
- PFX 91843** (486399) yellow

**A** **Pendaflex®**

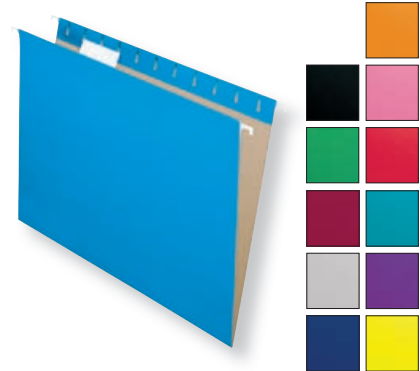

**B** **Pendaflex®**



**C** **Pendaflex®**



## D Hanging File Folders

Assorted colours. 1/5-cut. Includes tabs and inserts. Box of 25. Assorted colours. 10% post-consumer fibre.  
**BSN 5215AST** (1027127) letter



## E Hanging File Folders

Coating hanging rods for smooth sliding. Lighter interior colour reduces filing errors. 11-pt stock. Box of 25. Standard green. 10% post-consumer fibre.  
**PFX 81600C** (732529) letter  
**PFX 81620C** (732537) legal



## F Offix® Hanging File Folders

Standard green with nylon-tipped hanging rods. Suitable for rigid or flexible tabs. Box of 25.  
**NVX 349696** (349696) letter  
**NVX 349704** (349704) legal

**D** **B BUSINESS SOURCE®**



**E** **Pendaflex®**



## G Recycled Hanging File Folders

11-stock pt. Includes blank inserts and tabs. Box of 25. Standard green. Contains 100% post-consumer fibre.

### Letter size

- BSN 17532** (1027143) 1/3-cut
- BSN 17533** (1027176) 1/5-cut

### Legal size

- BSN 43569** (1027151) 1/3-cut
- BSN 43570** (1027168) 1/5-cut



**F** **offix**



**G** **B BUSINESS SOURCE®**





**A** **Pendaflex®**   25



**B** **Pendaflex®**   20

**A SureHook™ Reinforced Hanging Box File Folders**

Extra durability. Poly-laminated strips reinforce top and bottom edges. Closed sides. Stronger rods and flexible hooks so folders stay on track and slide with ease. 3 in. box bottom. Box of 25. Blue. 10% post-consumer fibre.  
**PFX 59203** (141325) letter  
**PFX 59303** (141341) legal

**B SureHook™ Reinforced Hanging File Folders**

Reinforced rod and flexible hook won't buckle under pressure. 2" bottom folders. Folders stay on rails and slide with ease. Box of 20. 10% recycled content, 10% post-consumer fibre.  
**Letter size**  
**PFX 6152X2C** (163857) standard green  
**PFX 6152X2CAS** (163865) assorted colours  
**Legal size**  
**PFX 6153X2C** (163873) standard green  
**PFX 6153X2CAS** (163881) assorted colours



**C** **Pendaflex®**   25



**D** **Pendaflex®**   20

**C Extra Capacity Hanging File Folders With Box Bottom**

11-pt stock includes pressboard reinforced bottom inserts. Reinforcement at upper and inside fold. Standard green. Box of 25. 10% post-consumer fibre.  
**PFX 04152X2** (486647) 2 in. bottom (letter)  
**PFX 04153X2** (486639) 2 in. bottom (legal)  
**PFX 04153X3** (486654) 3 in. bottom (legal)  
**PFX 04153X4** (734129) 4 in. bottom (legal)

**D Ready-Tab™ Reinforced Hanging Folders**

5 built-in tabs. 2" capacity box bottom holds up to 400 sheets. Box of 20. 10% post-consumer content.  
**Letter size**  
**PFX 42701** (772400) standard green  
**PFX42700** (566281) assorted colours  
**Legal size**  
**PFX 42703** (772426) standard green  
**PFX42702** (772418) assorted colours



**E** **Pendaflex®**   10



**F** **Pendaflex®**   10

**E SureHook® Reinforced Hanging File Folders With Dividers**

Kraft 2 dividers with two-sided fasteners. Laminated poly strips reinforce top and bottom edges. Tabs and inserts included. Flexible hooks allow folders to slide easily on rails. Legal size. Box of 10. Contains 10% post-consumer fibre.  
**PFX 59354** (185959)

**F Hanging Classification Folders**

25-pt pressboard cover. (20-pt for partitions). Fasteners inside both covers and both sides of partitions. 2 partitions. 2.8 in. capacity. Pivoting hangers. 2 in. expansion. Legal size. Blue. Box of 10. 30% post-consumer fibre.  
**PFX 59352** (277012)



**G** **Pendaflex®**   4



**H** **Winnable**

**G SureHook® Reinforced Extra Capacity Hanging Pockets**

Extra durability. Expansion of 3-1/2 in. Poly-laminated strips reinforce top and bottom edges. Full height gussets. Stronger rods and flexible hooks so folders stay on track and slide with ease. Package of 4. 10% post-consumer fibre.  
**Letter size**  
**PFX 09217** (141374) standard green  
**PFX 09213** (141358) assorted colours  
**Legal size**  
**PFX 09317** (141390) standard green  
**PFX 09313** (141382) assorted colours

**H Expanding Hanging File Folders**

Polypropylene. 7 pockets with index tabs and inserts. Retractable hanging arms. Legal size. Black.  
**WNN 202H-07-BK** (773101)



**I** **SMEAD®**

**I Poly Hanging Expanding Files**

13 pockets and 12 dividers. Large tabs with preprinted A-Z and monthly inserts. Acid and PVC free. Water resistant. Letter size. Black.  
**SMD 65125** (809376)



## A Viewables® Premium 3D Hanging Folder Tabs Kit

Allows you to create an organized, long-lasting system to manage your important files using colours. Includes Premium 3D poly tabs, multipurpose labels and clear label protectors.

**SMD 64905** (432153) 25 tabs  
**SMD 64910** (432187) 100 tabs



## B Viewables® Quick-Fold Hanging Folder Tabs Kit

Allows you to create an organized, long-lasting system to manage your important files using colours. Includes 45 Quick-Fold poly tabs, 48 multipurpose labels.

**SMD 64912** (432237)

## C Viewables® Premium 3D Hanging Folder Labels Kit

Allows you to create an organized, long-lasting system to manage your important files using colours. Includes 160 multipurpose labels.

**SMD 64915** (432245)



## D Reversaflex® Moulded Rigid Tabs

Lock into place and allow for top loading of inserts. Includes blank inserts. Box of 25. Clear.

**PFX 32-CR** (490300) 2 in.  
**PFX 33-1/2CR** (490375) 3-1/2 in.



## E Flexible Hanging Folder Tabs

Clear soft plastic tab. Tabs are angled for better viewing. Includes blank white inserts. Box of 25. Clear.

**PFX 42-CR** (490177) 2 in.  
**PFX 43-1/2CR** (490268) 3-1/2 in.

## F Inserts for Hanging Folder Tabs

Blank inserts give you the option to create file headings your way. 2 in. Package of 100. 10% post-consumer fibre.

**PFX 242** (487801)



## G Flexible Hanging Folder Tabs

Includes blank inserts. Designed to allow for easy insertion. Package of 25.

2 in.

**PFX94200** (490508) clear  
**PFX 97202** (566505) blue  
**PFX 97209** (566513) yellow  
**PFX 97211** (566521) red  
**PFX97225** (669960) green  
 3-1/2 in.  
**PFX94300X** (490516) clear  
**PFX 97302** (566539) blue  
**PFX 97309** (566547) yellow  
**PFX 97311** (566554) red  
**PFX 97325** (670018) green



## H Offix® Flexible Hanging Folder Tabs

Flexible clear plastic. With inserts. Pack of 25.

**NVX 569806** (569806) 2 in.  
**NVX 569814** (569814) 3-1/2 in.





**A**  **SAFCO**



**B** **Winnable**



**A Onyx™ Desktop Box File**

Convenient, portable file made of black steel mesh with powder coat finish. Open top for letter size hanging files. Integrated handles. Collapsible for compact storage when not in use. Black.  
**SAF 2169BL** (141432) 7 in. deep  
**SAF 2170BL** (141440) 11 in. deep

**B Mesh Hanging File Frame**

Mesh enamelled wire. 11-1/4 x 12-1/2 x 9-3/8 in. H. Letter size. Black.  
**WNN 11971** (231746)

**C Mesh Desktop Hanging File**

Enamel wire mesh. Black.  
**WNN14522** (231977) letter  
**WNN14523** (231985) legal

**D Hanging File Folder**

For letter size hanging folders. 30% recycled content.  
**DEF 39304** (238519)

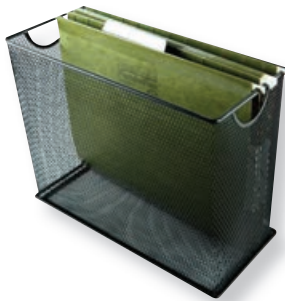

**C** **Winnable**

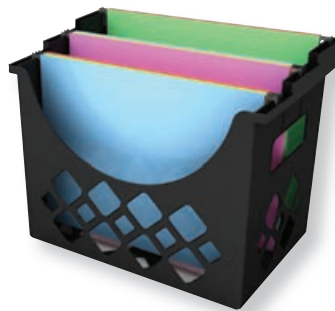

**D** **deflecto**



**E Desktopter® Desktop File**

Keeps projects or active files close at hand and arranged neatly. Fits in a desk drawer or filing cabinet and avoids the need for a hanging folder frame. Includes 5 hanging folders with tabs and inserts. Moulded with 100% post-consumer material. Black.  
**FEL 00534** (304600) letter  
**FEL 00544** (289314) legal

**F X-Rack® Hanging Folder Frame**

For letter or legal size hanging folders. 16 x 12 x 11 in. H. Black.  
**DEF XR206** (797100)

**G Speedframe Hanging Folder Frame**

Sturdy frame adjusts from 24 to 27 in., to accommodate letter or legal size hanging folders. Assembles in seconds without nuts and bolts.  
**PFX 450** (221374)



**E** **Feljowes**



**F** **deflecto**



**H Action Frame Drawer File Frame**

Make filing cabinets or desk drawers ready for suspension filing. Adjustable and easy to assemble. Fits in 14 to 18 inch size drawers. Includes plastic corner caps - no tools needed. Letter size. Made of steel. Box of 2.  
**PFX AFF24** (808824)

**I Premium Hanging Folder Frame**

Metal stainless steel. Quick and easy assembly. Adjusts to fit 24 to 27 inches deep drawers. Folders not included. Silver.  
**Letter size**  
**BSN 60529** (1027721) by each  
**BSN 26** (1027755) box 6  
**Legal size**  
**BSN 36** (809293) box 6



**G** **Reversaflex®**



**H** **Pendaflex®**



**I** **B BUSINESS SOURCE®**

**A Waterproof Labels**

For laser printer. Can be completely submerged in water without falling apart or off. Withstand damage from friction, smudging and up to one year of outdoor UV light. Package of 10 sheets

- AVE 35520 (829454) 1 x 2-5/8 in. (300)
- AVE 35523 (829455) 2 x 4 in. (100)
- AVE 35524 (829456) 3 x 4 in. (60)
- AVE 35526 (829457) 5-1/5 x 8-1/2 in. (20)



**B TrueBlock™ White Laser Shipping Labels**

For laser and inkjet printers. Permanent adhesive. TrueBlock technology covers everything underneath.

- Package of 10 sheets**  
AVE 08923 (530303) 4 x 2 in. (100)
- Package of 25 sheets**  
AVE05263 (100008) 4 x 2 in. (250)  
AVE05264 (773416) 4 x 3-1/3 in. (150)  
AVE 08126 (793364) 5-1/2 x 8-1/2 in. (50)  
AVE05265 (773424) 8-1/2 x 11 in. (25)
- Box of 100 sheets**  
AVE 05163 (236661) 4 x 2 in. (1000)  
AVE 05164 (236679) 4 x 3-1/3 in. (600)  
AVE 05168 (647321) 5 x 3-1/2 in. (400)  
AVE 05126 (793356) 5-1/2 x 8-1/2 in. (200)  
AVE 05165 (236687) 8-1/2 x 11 in. (100)
- Box of 250 sheets**  
AVE 05963 (773432) 4 x 2 in. (2500)

A



B



**C Easy Peel® White Laser Mailing Labels**

For laser and inkjet printers. Permanent adhesive. Pop-up Edge for fast peeling.

- Package of 10 sheets**  
AVE 08920 (454629) 2-5/8 x 1 in. (300)
- Package of 25 sheets**  
AVE 05267 (236596) 1-3/4 x 1/2 in. (2000)  
AVE 05195 (785022) 1-3/4 x 2/3 in. (1500)  
AVE 05260 (326132) 2-5/8 x 1 in. (750)  
AVE 08168 (138727) 3-1/2 x 5 in. (100)  
AVE 05261 (416099) 4 x 1 in. (500)  
AVE 05262 (481911) 4 x 1-1/3 in. (350)  
AVE 05259 (416081) 4 x 1-1/2 in. (350)
- Box of 100 sheets**  
AVE 05167 (416065) 1-3/4 x 1/2 in. (8000)  
AVE 05160 (236604) 2-5/8 x 1 in. (3000)  
AVE 05161 (236620) 4 x 1 in. (2000)  
AVE 05162 (236653) 4 x 1-1/3 in. (1400)  
AVE05159 (236646) 4 x 1-1/2 in. (1400)
- Box of 250 sheets**  
AVE 05960 (481283) 2-5/8 x 1 in. (7500)  
AVE 05961 (481291) 4 x 1 in. (5000)  
AVE05962 (481309) 4 x 1-1/3 in. (3500)

C



D



**D EcoFriendly White Mailing Labels**

For laser and ink jet printers. White matt finish. 100% recycled content, 100% post-consumer. Certified FSC®.

- Package of 10 sheets**  
AVE48867 (138917) 1-3/4 x 1/2 in. (800)  
AVE 48860 (138883) 2-5/8 x 1 in. (300)  
AVE48863 (138891) 4 x 2 in. (100)
- Package of 25 sheets**  
AVE 48160 (108431) 2-5/8 x 1 in. (750)
- Box of 100 sheets**  
AVE 48460 (108464) 2-5/8 x 1 in. (3000)  
AVE48464 (108480) 3-1/3 x 4 in. (600)  
AVE48163 (108456) 4 x 2 in. (1000)

E



F



**E Easy Peel® Clear Mailing Labels**

For laser and inkjet printers. Pop-up edge for fast peeling. Permanent adhesive.

- Package of 10 sheets**  
AVE 7667 (353151) 1/2 x 1-3/4 in. (800)  
AVE 7668 (353169) 2/3 x 1-3/4 in. (600)  
AVE 7666 (353144) 1 x 2-5/8 in. (300)  
AVE 7661 (353185) 1 x 4 in. (200)  
AVE 7662 (353193) 1-1/3 x 4 in. (140)  
AVE 7663 (353201) 2 x 4 in. (100)  
AVE 7664 (353219) 3-1/3 x 4 in. (60)  
AVE 7665 (353227) 8-1/2 x 11 in. (10)
- Package of 25 sheets**  
AVE 7660 (353177) 1 x 2-5/8 in. (750)

**F White Mailing Labels**

- For copier. Permanent adhesive  
AVE 45004 (6288) 2-13/16 x 1 in. (3300)  
AVE 45008 (212787) 2-13/16 x 1-1/2 in. (2100)  
AVE 45005 (212753) 4-1/4 x 2 in. (1000)





**A Rectangle Shipping Labels**

For laser and inkjet printers. Jam-free and smudge-free guarantee. Add your own logo, graphics and information. Box of 250 sheets.  
**AVE 35126** (828111) 8-1/2 x 5-1/2 in. (500)  
**AVE 35163** (828112) 2 x 4 in. (2500)  
**AVE 35164** (828113) 3-1/3 x 4 in. (1500)

**B High Visibility Labels**

For laser and inkjet printers. Permanent adhesive.  
**2-5/8 x 1 in. - package of 750 labels**  
**AVE 05970** (286476) magenta  
**AVE 05971** (286484) green  
**AVE 05972** (286492) yellow  
**AVE05979** (609156) assorted colours (pkg 450)  
**4 x 2 in. - package of 150 labels**  
**AVE 05973** (785030) assorted colours  
**8-1/2 x 11 in. - package of 25 labels**  
**AVE05939** (426858) orange  
**AVE 05933** (1029479) green  
**AVE 05936** (1029487) magenta  
**AVE05938** (426841) yellow



**C High Visibility Labels**

For laser printers. Permanent adhesive. Jam-free.  
**1 x 2-5/8 in. - package of 750 labels**  
**BSN 26138** (1029256) pink  
**BSN 26139** (1029248) green  
**BSN 26140** (1029263) yellow  
**2 x 4 in. - package of 250 labels**  
**BSN 26141** (1029289) pink  
**BSN 26142** (1029271) green  
**BSN 26143** (1029297) yellow

**D Labels for Copiers**

For copiers. Permanent adhesive. Acid-free. Jam-free. 8-1/2 x 11 in. 100 labels. Package of 100 sheets.  
**BSN 26133** (1029065)



**E Premium Mailing Labels**

For ink-jet and laser printers. Permanent adhesive. Premium print quality. Acid-free. Jam-free. White.  
**Package of 25 sheets**  
**BSN 26107** (1029123) 1/2 x 1-3/4 in. (2000)  
**BSN 26109** (1029115) 1 x 2-5/8 in. (750)  
**Package of 100 sheets**  
**BSN26108** (1029099) 1/2 x 1-3/4 in. (8000)  
**BSN21050** (1029164) 1 x 2-5/8 po. (3000)  
**BSN26112** (1029172) 1 x 4 in. (2000)  
**BSN26114** (1029404) 1-1/3 x 4 in. (1400)  
**BSN26116** (1029198) 2 x 4 in. (1000)  
**BSN21052** (1029214) 3-1/3 x 4 in. (600)  
**BSN26120** (1029305) 3-1/2 x 5 in. (400)  
**BSN26161** (1029222) 5-1/2 x 8-1/2 in. (200)  
**BSN26119** (1029313) 8-1/2 x 11 in. (100)  
**Package of 250 sheets**  
**BSN 21051** (1029157) 1 x 2-5/8 in. (7500)  
**BSN 26113** (1029180) 1 x 4 in. (5000)  
**BSN 26117** (1029206) 2 x 4 in. (2500)

**F Offix® White Labels**

For laser printers and inkjet. Permanent adhesive. Package of 100 sheets.  
**NVX367003** (367003) 2-5/8 x 1 in. (3000)  
**NVX367011** (367011) 4 x 1 in. (2000)  
**NVX367029** (367029) 4 x 1-1/2 in. (1400)  
**NVX367037** (367037) 4 x 2 in. (1000)  
**NVX367045** (367045) 4 x 3-1/3 in. (600)  
**NVX367052** (367052) 8-1/2 x 11 in. (100)

**G White Dot Matrix Address Labels**

Single row. 12" fanfold. Perforation between each label. Permanent adhesive. Box of 5000.  
**AVE 04060** (308353) 3-1/2 x 1-7/16 in.  
**AVE 04014** (308379) 4 x 1-7/16 in.  
**AVE04022** (326199) 4 x 1-15/16 in.

**H PRES-a-Ply Copier Labels**

Permanent adhesive. 2-3/4 x 1 in. 3000 labels. Certified FSC®.  
**AVE 30400** (416172)





# Labeling Solutions Designed to Help You Drive Your Business

- ✓ Wide selection of products in various sizes, shapes, textures and colours
- ✓ Permanent adhesive works on glass, plastic, paper and more
- ✓ Design and customize labels to present a polished, professional look
- ✓ Free templates available on [avery.ca](https://avery.ca)





**A**



**B**



**C**



**A Dissolvable White Round Labels**

For laser and ink jet printer. Label washes away in seconds with warm water, leaving no sticky residue. 2 in. diameter. Package of 60 labels. **AVE22205** (426890)

**B Glossy White Oval Labels**

For ink jet and laser printers. Print-to-the-edge. 1-1/2 x 2-1/2 in. Package of 180 labels. **AVE22804** (186965)

**C Square White Labels**

For ink jet and laser printers. Print-to-the-edge. 1-1/2 x 1-1/2 in. Package of 600 labels. **AVE 22805** (186973)

**D Square White Labels**

For ink jet and laser printers. Print-to-the-edge. 2 x 2 in. Package of 300 labels. **AVE 22806** (186999)

**E Glossy White Round Labels**

For ink jet and laser printers. Print-to-the-edge. 2 in. diameter. Package of 120 labels. **AVE22807** (187005)

**F Kraft Brown Round Labels**

For ink jet and laser printers. Print-to-the-edge. 2-1/2 in. diameter. Package of 225 labels. Brown. **AVE22808** (187054)

**G White Wine Labels**

Water resistant. For ink jet and laser printers. Print-to-the-edge. 4-3/4 x 3-1/2 in. Package of 40 labels. **AVE22811** (599068)

**H Glossy Clear Round Labels**

For ink jet and laser printers. Print-to-the-edge. 2 in. diameter. Package of 96 labels. **AVE22815** (598920)

**I Glossy Clear Rectangular Labels**

For ink jet and laser printers. Print-to-the-edge. 2 x 3 in. Package of 80 labels. **AVE22822** (221671)

**J Silver Foil Round Labels**

Embossed labels. For inkjet printer. 2 in. diameter. Package of 96 labels. **AVE22824** (221697)

**K Durable White Rectangular Labels**

Designed for outdoor environments. Resists moisture, scuffing and tearing. Removable adhesive. For ink jet and laser printers. Print-to-the-edge. 4-3/4 x 3-1/2 in. Package of 32 labels. **AVE22827** (221713)



**D**



**E**



**F**



**G**



**H**



**I**



**J**



**K**



**A Glossy White Round Labels**

For ink jet and laser printers. Print-to-the-edge. 2-1/2 in. diameter. Package of 90 labels. **AVE22830** (221721)



**A**



**B Printable Lid Seal Labels**

For ink jet and laser printers. Print-to-the-edge. 1-1/2 x 4 in. Package of 90 labels. Hemp. **AVE22832** (828513)



**B**



**C Glossy White Square Labels**

For ink jet and laser printers. Print-to-the-edge. 2 x 2 in. Package of 120 labels. **AVE22833** (828514)



**C**



**D Gold Foil Rectangle Labels**

For inkjet printer. Print-to-the-edge. 1-1/3 x 4 in. Package of 70 labels. **AVE22839** (828518)



**D**



**F Hemp Round Labels**

For inkjet and laser printers. Print-to-the-edge. 2-1/2 in. diameter. Package of 90 labels. **AVE22842** (828516)



**E**



**G Clear Static Cling Labels**

Sticks without adhesive. For laser printers. 8-1/2 x 11 in. Package of 8 labels. **AVE22843** (828519)



**F**



**H Durable White Wraparound Labels**

Flexible label conforms to curved surfaces giving a smooth application. Water-resistant. For laser and inkjet printers. 1-1/4 x 9-3/4 in. Package of 40 labels. **AVE22845** (535369)



**G**



**I White Vinyl Film Labels**

Removable. For laser printers. 8-1/2 x 11 in. Package of 8 labels. **AVE22851** (828520)



**H**



**J White Round Tags**

For laser and inkjet printers. Print-to-the-edge. 2 in. diameter. Package of 120 labels. **AVE22857** (828517)



**I**



**K Glossy White Oval Labels**

For ink jet and laser printers. Print-to-the-edge. 3 x 4 in. Package of 40 labels. **AVE24489** (1029446)



**J**



**K**





**A**



**B**



**A White I.D. Labels**

Removable. For ink jet and laser printers. Package of 10 sheets.  
**AVE 06504** (217984) 1-3/4 x 1/2 in. (800)  
**AVE 06468** (165894) 2 x 4 in. (120)  
**AVE 06498** (217885) 2-5/8 x 1 in. (300)  
**AVE 06499** (217950) 4 x 3 in. (60)  
**AVE 06503** (217976) 8-1/2 x 11 in. (10)

**B White I.D. Labels**

Permanent adhesive. For ink jet and laser printers. 8-1/8 x 5 in. 30 labels. Package of 15 sheets.  
**AVE 06573** (697789)

**C Round Coding Labels with Border**

Removable adhesive. 1-1/4 in. diameter. Package of 80. Assorted colours.  
**AVE 2332** (594564)

**D Self-Adhesive Colour Coding Labels**

Rectangular, removable adhesive. 1 x 3 in. Assorted colours. Package of 75.  
**AVE 2334** (594572)

**E Self-Adhesive Colour Coding Labels**

Round, removable adhesive. 3/4 in. diameter. Package of 240. FSC® Certified.  
**AVE 2343** (594655) red  
**AVE 2345** (594630) blue  
**AVE2344** (596692) green  
**AVE 2346** (594648) yellow  
**AVE2347** (599399) neon red  
**AVE2348** (594671) assorted colours

**F Self-Adhesive Colour Coding Labels**

Round, removable adhesive. 1/4 in. diameter. Package of 768. FSC® Certified.  
**AVE2335** (594614) red  
**AVE 2395** (599118) blue  
**AVE 2394** (599100) green  
**AVE 2396** (599126) yellow  
**AVE2339** (594606) assorted colours

**G Self-Adhesive Colour Coding Labels**

Round, removable adhesive. 1/2 in. diameter. Package of 420. FSC® Certified.  
**AVE 2397** (599134) red  
**AVE 2398** (599142) green  
**AVE 2399** (599159) yellow

**H Self-Adhesive Labels Translucent**

Round, removable adhesive, translucent. Assorted colours.  
**AVE 2370** (1029495) red, green, yellow, blue  
**AVE 2369** (1029503) red, lime, blue, green



**C**



**D**



**E**



**F**



**G**



**H**



**A High Visibility ID Labels**

Removable. For ink jet and laser printers. Assorted neon colours.  
**AVE 06476** (165936) 1 x 2-5/8 in. (240)  
**AVE 06477** (165944) 2 x 4 in. (80)



**B UltraDuty™ GHS Chemical Labels**

Waterproof. Chemical-, abrasion-, UV-, and tear-resistant.  
 For laser printer. BS5609 Certified.

**Square**  
**AVE60506** (521922) 2 x 2 in. (600)  
**AVE 60504** (521914) 4 x 4 in. (200)  
**Rectangular**  
**AVE 60505** (370569) 2 x 4 in. (500)  
**AVE 60503** (370551) 3-1/2 x 5 in. (200)  
**AVE 60502** (571679) 4-3/4 x 7-3/4 in. (100)  
**AVE 60501** (370544) 8-1/2 x 11 in. (50)



**C White High Visibility Labels**

For inkjet printers. 1-1/2 in. diameter. Package of 400.  
**AVE 08293** (386714)

**A**

**B**

**C**

**D Transparent Mailing Seals**

Permanent adhesive. 1 in. diameter. Package of 75.  
**AVE 2355** (594465)

**E White Multi-Purpose Labels**

Removable.  
**Round**  
**AVE2309** (1000389) 3/4 in. ( 480 )  
**Square**  
**AVE2374** (1029454) 1-1/2 in. (15)  
**Rectangular**  
**AVE2310** (1000363) 3/8 x 5/8 in. (720)  
**AVE 2311** (594481) 1/2 x 3/4 in. (540)  
**AVE 2312** (594473) 1/2 x 1-3/4 in. (400)  
**AVE 2313** (594507) 3/4 x 1 in. (400)  
**AVE 2314** (594499) 1 x 3 in. (125)  
**AVE 2315** (594523) 2 x 3 in. (75)  
**AVE 2316** (594531) 2 x 4 in. (50)  
**AVE 2317** (594549) 6 x 4 in. (15)

**D**

**E**

**F**

**F Report Cover Labels**

Rectangular, permanent adhesive. 1 x 3-1/2 in. White with blue border.  
 Package of 25.  
**AVE 2318** (594556)

**G No-Iron Clothing Labels**

Perfect for t-shirts, jackets, hats, backpacks and more.  
 Just write, peel and stick. No ironing required. Machine washable.  
 Permanent adhesive withstands multiple washer and dryer cycles.  
**AVE2375** (594598) 1/2 x 1-3/4 in. (72)  
**AVE 2356** (594580) assorted shapes (45)

**G**

**H**

**I**

**H Self-Laminating Labels**

Assorted shapes and sizes. Permanent adhesive. Package of 30.  
**AVE 2362** (594739) primary colours  
**AVE 2363** (594721) neon colours



**I CD Labels**

Permanent adhesive. With built-in alignment guide and spine label for jewel box. Case inserts not included. For inkjet and laser printers.  
**400 CD labels and 800 spine labels**  
**AVE 07692** (353235)  
**200 CD labels and 400 spine labels**  
**AVE 05584** (633677)

**J White Durable Labels**

Extra strong adhesive. Resistant to moisture, extreme temperatures, solvents, tearing and smearing. For laser printer.  
**AVE 06576** (713735) 1-3/4 x 1-1/4 in. (1600)  
**AVE 06578** (713743) 2-5/8 x 2 in. (750)  
**AVE06579** (753806) 8-1/8 x 5 in. (100)  
**AVE06575** (713727) 8-1/2 x 11 in. (50)

**J**

**K**



**K Printable Fabric**

Print cotton fabric to iron or sew on craft projects. For inkjet printer.  
 11 x 8-1/2 in. Package of 5.  
**AVE 03384** (1029438)



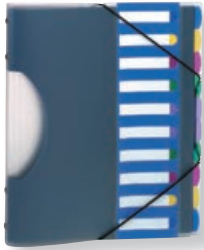

**A** **Pendaflex®**



**B** **Pendaflex®**



**C** **Winnable**

**A PileSmart® Project Sorter**

Durable polypropylene, moisture resistant. Removable and customizable colour index sheet. 10 colour-coded sorting tabs. Elastic tie closure. Letter size. Blue.  
**PFX 50995** (711770)

**B Project Sorter**

Five tabbed, removable pockets. Includes insertable top-loading title page holder and security flap. Made of super durable translucent polypropylene. Letter size.  
**PFX 53498C** (723981)

**C Heavy-Duty Transparent Folders**

Thick poly antistatic pockets. Sealed on 2 sides. Letter size. Capacity of 20 sheets. Package of 25. Clear.  
**WNN 07902** (186114)

**D Heavy-Duty Transparent Folders**

Thick poly antistatic pockets. Sealed on 2 sides. Capacity of 50 sheets. Package of 12.

**Letter size**  
**WNN E310L-CR** (320945) clear  
**WNN E310L-BE** (320952) blue  
**WNN E310L-GN** (321026) green  
**WNN E310L-RD** (320960) red  
**WNN E310L-YW** (321018) yellow  
**Legal size**  
**WNN E355L-CR** (320978) clear

**E Protective File Pockets**

Clear cut on both sides with thumb hole. Package of 10.  
**12 x 9-5/8 in.**

**VLB 60271** (543694) blue  
**VLB 60270** (1025726) smoke  
**VLB 60272** (543702) red  
**VLB 60273** (543710) clear  
**VLB 60274** (1025718) purple  
**VLB 60275** (543728) green  
**VLB 60276** (543736) yellow  
**11 x 17 in.**  
**VLB 61173** (1025700) clear

**F Protective Folders**

Translucent polypropylene. Non-stick. Archival quality. Notched side opening. Sealed on 2 sides. Capacity of 20-25 sheets. Package of 10.

**Letter size**  
**GMX 87511-C10** (629311) clear  
**GMX 87511-B10** (629329) blue  
**GMX 87511-G10** (629337) green  
**GMX 87511-R10** (629345) red  
**GMX 87511-Y10** (629352) yellow  
**Legal size**  
**GMX 87514-C10** (629303) clear

**G Poly View Tabbed Folders**

Polypropylene. 1/3-cut tab. Wear, tear and moisture resistant. Security cover with flap. Sealed on 2 sides. Letter size. Package of 6.

Assorted colours.  
**PFX 52565** (697433)

**H Project Organizer**

Glossy polyvinyl. Legal size. 5 removable coloured pockets with tabs and labels.

**PFX 53701C** (702373)

**I Pendaflex® Expanding Sorter**

Built in dividers with pre-printed, alphabetic (A-Z) index tabs. Reinforced accordion style gussets. 11-3/4 x 10 in. Navy.

**PFX DDF3-0X** (466136)

**J Sort-All™ File Sorter**

Plastic. Features 31 flexible leaves with tabs printed in five categories : alphabetical, monthly, numerical, day-of-the-month, day-of-the-week. Anti-skid feet.

**PFX 40652** (260695)



**D** **Winnable**



**E** **vlb**



**F** **GEMEX**



**G** **Pendaflex®**



**H** **TOPS PRODUCTS**



**I** **TOPS PRODUCTS**



**J** **Pendaflex®**

## A File Jacket

Manila. Reinforced straight-cut tab. 10% post-consumer fibre.  
**Exp. : 1-1/2 in. - package of 10**  
**PFX 3033D-CP10** (163766) letter  
**PFX 3035D-CP10** (163782) legal  
**Exp. : 2 in. - sold by each**  
**PFX 22200** (664474) letter  
**PFX 23200** (664482) legal

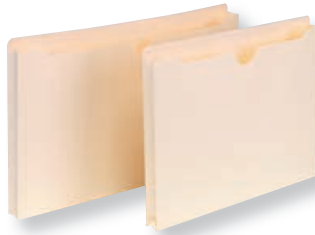

**A** **Pendaflex®**



**B** **Pendaflex®**



## B File Jacket

Manila. Straight-cut tab. 10% post-consumer fibre.  
**Without expansion - sold by each**  
**PFX 22000** (351619) letter  
**PFX 23900** (351627) legal  
**1 in. expansion - box of 50**  
**PFX 12100** (372441) letter  
**PFX 23100** (372458) legal  
**1-1/2 in. expansion - box of 25**  
**PFX 12121** (186007) letter



## C File Jacket

Manila. Reinforced straight-cut tab. 10% recycled content, 30% post-consumer.  
**Without expansion - box of 100**  
**BSN 65796** (1027416) letter  
**1-1/2 in. expansion - box of 50**  
**BSN 65802** (1028281) legal  
**2 in. expansion - box of 50**  
**BSN 65799** (1028372) letter  
**BSN 65803** (1028315) legal



**C** **B BUSINESS SOURCE®**



**D** **Pendaflex®**



## D File Jacket

Straight-cut tab. 1 in. expansion. Sealed on 3 sides with notch.  
 Box of 10. Assorted colours. 10% post-consumer fibre.  
**PFX 3023D-CP10** (186023) letter  
**PFX 3025D-CP10** (186031) legal



**E** **TOPS PRODUCTS**



**F** **SMEAD®**



## E Glow File Jacket

2 in. expansion. Letter size. Package of 10. Assorted colours.  
**PFX 49501** (420810)



## F Notes File Jackets

Letter size. 3 each of aqua, golden rod, pink and yellow.  
 Packages of 12. Assorted colours. 10% post-consumer fibre.  
**SMD 75616** (432351) no expansion  
**SMD 75694** (432369) 2 in. expansion

## G File Jacket with Flap

Protective flap with bungee cord. 2 in. expansion. Letter size.  
 Box of 10. Assorted colours. 10% post-consumer fibre.  
**SMD 77207** (427690)



**G** **SMEAD®**



**H** **SMEAD®**

## H Organized Up® Expanding Slash Jacket

Fronts angled for easy viewing of documents. 1 in. expansion.  
 8 1/2 x 11 in. Package of 5. Assorted colours.  
**SMD 75445** (1036532)



## I Expandable Taped Button Wallet

Made from 100% oxo-biodegradable polypropylene. Letter size.  
 High capacity 3-in. expansion. Sewn edges. Snap closure.  
**AVD A00328** (366237)



**I** **ecooffice**



## J Poly Project Organizer

### With Zippered Pouch

Durable and waterproof polypropylene resists tears and moisture.  
 Zip closure on the front. Closed on three sides. Expands to 1/2 in.  
 Letter size. Package of 3. Assorted colours.  
**SMD 89614** (432377)



**J** **SMEAD®**

Great for a backpack

**A Winnable** **N 2023**

Great for a backpack

**B TOPS PRODUCTS**

**A Vertical Nylon Pouch**  
Water resistant. With clear front pocket. Velcro closure. Letter size.  
**WNN 20131** (832971) black  
**WNN 20132** (832972) blue  
**WNN 20133** (832973) red

**B Slimline Vertical File**  
7 pockets. Snap closure. Moisture-resistant poly. Assorted colours.  
**PFX 43315** (519884)

**C Poly File Jacket**  
Durable polypropylene. Water-and tear-resistant. 1 in. expansion. Legal size. Package of 5. Assorted colours.  
**PFX 50993** (711861)

**D Poly File Pockets**  
Durable polypropylene. 1 in. expansion. Package of 5. Assorted colours.  
**WNNFJ-01-AD** (745976) letter  
**WNN FJ-02-AD** (429407) legal

**C Pendaflex®**

**D Winnable**

**E File Jacket**  
Sturdy polypropylene. Clear front. Package of 5.  
**Letter size**  
**VLB 37251** (594234) blue  
**VLB 37255** (594275) green  
**VLB 37256** (594242) yellow  
**Legal size**  
**VLB 37151** (594259) bleu  
**VLB37152** (161646) red  
**VLB 37155** (594267) green

**F Offix® Document Pockets**  
Poly pockets sealed on 2 sides with notch. Holds up to 20 sheets. Package of 25.  
**NVX 11875AST25** (833138) letter (assorted colours)  
**NVX 11875-C25** (833139) letter (transparent)  
**NVX 14875-C10** (833140) legal (transparent)

**G Swirl Expandable File**  
Polypropylene. Bungee cord closure. Expansion of 1-1/2 in. Letter size. Assorted colours.  
**VLB AE93280** (180018)

**E vlb**

**F offix**

**H Large Size Expanding Wallet**  
12 x 18 in. wallet holds 11 x 17 in. documents. Flap and bungeecord closure. 3-1/2 in. expansion holds 875 sheets. 10% post-consumer fibre.  
**PFX B1060E** (350298)

**I Earthwise® Recycled Expanding File**  
Expansion of 5-1/4 in. Red fiber. Reinforced gussets. Holds up to 1,200 sheets. Legal size. Package of 3. 100% recycled content, 30% post-consumer fibre.  
**PFX06347** (788208)

**J File Wallet**  
Tyvek lined gussets. 5-1/4 in. expansion. Durable fold-over flap with bungee closure. 30% post-consumer fibre.  
**BSN 26575** (1028422) letter  
**BSN 26576** (1028414) legal

**G vlb**

For 11 x 17 inch documents

**H Pendaflex®**

**I Earthwise®**

**J BUSINESS SOURCE®**

## A File Pocket

Durable red fiber. Double thick manila lined front and back. Straight-cut tab. 30% post-consumer fibre.

**1-3/4 in. expansion - 400 sheet capacity**

**PFX 1514C-0X** (221879) letter

**PFX 1516C-0X** (221960) legal

**3-1/2 in. expansion - 800 sheet capacity**

**PFX1524E-0X** (190371) letter

**PFX 1526E0X** (222018) legal

**5-1/4 in. expansion - 1200 sheet capacity**

**PFX1534G0X** (190389) letter

**PFX 1536G0X** (222026) legal



**A** **Pendaflex®**



**B** **Pendaflex®**



## B Premium Reinforced File Pocket

Cross-bonded tear-resistant gussets. Reinforcement strips at critical wear points to prevent bursting. 10% post-consumer fibre.

**3-1/2 in. expansion - 800 sheet capacity**

**PFX085343** (244053) letter

**PFX085363** (190355) legal

**5-1/4 in. expansion - 1200 sheet capacity**

**PFX 085545** (432112) letter

**PFX 085565** (190363) legal

**7 in. expansion - 1600 sheet capacity**

**PFX 45302** (664490) letter

**PFX 45303** (664508) legal

## C Heavy-Duty File Pocket

24-pt front and back panels. Fully lined Tyvek gussets. 3-1/2 in. expansion. 700 sheet capacity. Legal size. Box of 25. 10% post-consumer fibre.

**GLW C1526EHD** (346809)



**C** **Pendaflex®**



**D** **Pendaflex®**



## D Expanding File Pocket

Redrope. 22 pt. front and back panels. Fully lined Tyvek gussets. Recycled content: 10%, post-consumer waste: 10%.

**3-1/2 in. expansion - 800 sheet capacity**

**PFX ECDB1524E** (1027291) letter

**PFXECDB1526E** (528281) legal

**5-1/4 in. expansion - 1200 sheet capacity**

**PFX ECDB1534G** (1027309) letter

**PFXECDB1536G** (533000) legal

## E End Tab File Pocket

11-pt manila. Double-ply straight cut with full tabs. Reinforced gussets. 3-1/2 in. expansion. 400 sheet capacity. Legal size. 30% post-consumer fibre.

**PFX 22822** (351049)

For lateral filing



**E** **Pendaflex®**



## F Tuff® End Tab File Pocket

Very durable. Straight-cut. Reinforced tab. Fully Tyvek-lined gusset has special rollover reinforcement at the top. Reinforcement strip at the point of stress. 7 in. expansion. 1600 sheet capacity. Legal size. 30% post-consumer fibre.

**SMD 74795** (120204)

For lateral filing



**F** **SMEAD®**



## G Heavy-Duty End Tab File Pocket

Perfect for frequent use files. 17-pt. Drop front allows for easy access for fast retrieval of material. Scored on sides. 30% post-consumer fibre.

**3-1/2 in. expansion - 800 sheet capacity**

**PFX 95343** (658351) letter

**PFX95545** (658369) legal

**5-1/4 in. expansion - 1200 sheet capacity**

**PFX95363** (734863) letter

**PFX95565EE** (734871) legal

For lateral filing



**G** **Pendaflex®**





**A** **Earthwise**  
PENDAFLEX



**B** **SMEAD**



**A Earthwise® File Pocket**

Rollover reinforced gussets. Redrope. 100% recycled content; 30% post consumer fiber.  
**3-1/2 in. expansion - 800 sheet capacity**  
**PFX E1524E-CA** (351064) letter  
**PFX E1526E-CA** (351296) legal  
**5-1/4 in. expansion - 1200 sheet capacity**  
**PFX E1534G-CA** (351197) letter  
**PFX E1536G-CA** (351205) legal

**B Tuff® File Pocket**

Very durable. Straight-cut. Reinforced tab. Fully Tyvek-lined gusset has special rollover reinforcement at the top. Reinforcement strip at the point of stress. 30% post-consumer fibre.  
**3-1/2 in. expansion - 800 sheet capacity**  
**SMD 74380** (643577) legal  
**5-1/4 in. expansion - 1200 sheet capacity**  
**SMD 74390** (643593) legal  
**7 in. expansion - 1600 sheet capacity**  
**SMD 73395** (120550) letter  
**SMD 74395** (120568) legal



**C** **SMEAD**



**D** **SMEAD**



**C Easy Grip® File Pocket**

Non-slip grip strips provides twice as much grip as standard pocket. Rollover tear-resistant reinforcement on the sides. Straight-cut tab. 6-1/2 in. high gussets. 30% post-consumer fibre.  
**3-1/2 in. expansion - 800 sheet capacity**  
**SMD 73208** (120469) letter  
**SMD 73210** (120485) legal  
**5-1/4 in. expansion - 1200 sheet capacity**  
**SMD 73209** (120477) letter  
**SMD 73211** (120493) legal

**D Recycled File Pocket**

Redrope. Straight-cut tab. Rollover tear-resistant reinforcement at the top of the side gusset. 100% recycled content, 30% post-consumer fibre.  
**3-1/2 in. expansion - 800 sheet capacity**  
**SMD 73205** (120428) letter  
**SMD 74205** (120444) legal  
**5-1/4 in. expansion - 1200 sheet capacity**  
**SMD 73206** (831256) letter  
**SMD 74206** (120451) legal



**E** **Pendaflex**



**F** **B BUSINESS SOURCE**

**E Coloured File Pocket**

Double-thick front and back. Reinforced, tear-resistant gussets. Moisture resistant coating. 3-1/2 in. expansion. 400 sheet capacity. 10% post-consumer fibre.  
**Letter size**  
**PFX 1524EB-OX** (663906) blue  
**PFX 1524ER-OX** (663922) red  
**Legal size**  
**PFX 1526EB-OX** (663948) blue  
**PFX 1526EG-OX** (663955) green  
**PFX 1526ER-OX** (663963) red  
**PFX1526E-YEL** (1027382) yellow

**F Colour File Pocket**

Tyvek-reinforced gussets. 3-1/2 in. expansion. 400 sheet capacity. Letter size.  
**BSN 26550** (1028216) blue  
**BSN 26553** (1028240) yellow  
**BSN 26551** (1028224) green  
**BSN 26552** (1028232) red



**G** **Winnable**

**G Poly File Pocket**

Translucent polypropylene. Blue.  
**3-1/2 in. expansion - 800 sheet capacity**  
**WNN FP-31DB** (755181) letter  
**WNN FPL-31DB** (755207) legal  
**5-1/4 in. expansion - 1200 sheet capacity**  
**WNNFP-51DB** (755223) letter  
**WNNFPL-51DB** (755249) legal

## A Expanding File

Durable red fiber. Elastic cord closure. 30% post-consumer fibre.

**1 compartment. 1-3/4 in. exp. - 400 sheet capacity**

**PFX E22-2-B** (219873) legal

**1 compartment. 3-1/2 in. exp. - 800 sheet capacity**

**PFX E19-4-B** (219832) letter

**PFXE22-4-B** (3020) legal

**1 compartment. 5-1/4 in. exp. - 1200 sheet capacity**

**PFX E19-6-B** (219857) letter

**PFXE22-6-B** (219899) legal

**4 compartments. 3-1/2 in. exp. - 800 sheet capacity**

**PFX E22-4P-B** (219881) legal

**6 compartments. 5-1/4 in. exp. - 1200 sheet capacity**

**PFX E19-6P-B** (219865) letter

**PFXE22-6P-B** (219907) legal



## B Kraft Expanding File

Full flap with elastic closure. Pre-printed partition headings. Reinforced gussets, double thick front and back. 10% post-consumer fibre.

**1 to 31**

**PFX K17D-OX** (30361) letter

**PFXK19D-OX** (3038) legal

**A to Z**

**PFX K17A-OX** (30353) letter

**PFX K19A-OX** (219998) legal

**A** **Pendaflex®**

## C Expanding File

Red fiber. Moisture resistant to protect against spills and dampness.

Open top for quick access. Interior pockets and reinforced

compartments. Double thick front and back. 30% post-consumer fibre.

**1-31**

**PFX R17D-OX** (220137) letter

**PFX R19D-OX** (4630) legal

**A to Z**

**PFX R17A-OX** (220111) letter

**PFX R19A-OX** (4614) legal

**JAN to DEC**

**PFX R17M-OX** (220145) letter

**PFXR19M-OX** (4622) legal



**B** **Pendaflex®**



**C** **Pendaflex®**



## D Pocket Expanding File

Polypropylene. Index tabs and labels. Full cover flap features elastic closure. Letter size.

**7 pockets**

**PFX 55633BE** (279299) blue

**13 pockets**

**PFX 39624BE** (279273) blue

**PFX39624BLA** (535591) black

**PFX 39624GY** (279281) grey



**D** **Pendaflex®**

## E Expanding Poly File

Water-resistant polyurethane. 7 pockets. Black flap with elastic closure.

Index tabs and inserts to help organize and file. Letter size.

**PFX 67440BLU** (350223) blue

**PFX 67440GRN** (350231) green

**PFX 67440RED** (350249) red



**E** **TOPS PRODUCTS**

## F 7-Pocket Expanding File

Polypropylene. With blank, A-Z and monthly tab inserts,

Flap and cord closure. Letter size. Assorted colours.

**PFX E55633** (270561)

**F** **Cardinal®**

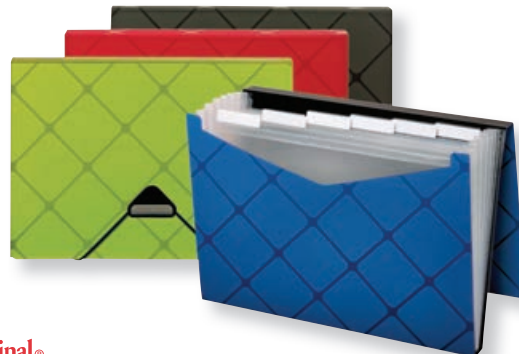



**A** FIVE STAR  
★★★★★



**B** Winnable



**A Style Expanding File**

Polypropylene. 6 pockets. Elastic cord closure. Notches for pen storage.  
13 x 9,4 in. Ivory diamonds motif.  
HLR 350002A-22 (828300)

**B Expanding File**

Vinyl. 13 pockets. With tabs monthly and A-Z inserts.  
**Cheque size**  
WNN200-12-DB (664516) blue  
WNN200-12-BK (664524) black  
**Letter size**  
WNN 201-12-DB (664532) blue  
WNN201-12-BK (664540) black  
**Legal size**  
WNN 202-12-DB (664557) blue  
WNN202-12-BK (664565) black

**C Windowfile™ Expanding File**

Flap with elastic tie and button closure. Index tabs with inserts.  
Clear window on top of flap. Letter size. Assorted colours.  
WNN 20140 (351403) 7 pockets  
WNN 201V-12-AD (765347) 13 pockets

**D 7-Pocket Expanding File**

6 pull-up reminder tabs. Reinforced gussets. Clear pocket to insert a custom cover. Zipper closure. Letter size. Assorted colours.  
HLR 35300 (210195)

**E 13-Pocket Expanding File**

Poly. Bungee closure and re-inforced gussets. Reinforced gussets.  
13 x 9-5/8. Assorted colours.  
HLR 35304 (210211)

**F Eco-Friendly Expanding Topview File**

The clear window makes viewing what is inside the file easy. Recycled polypropylene. 100% oxo-biodegradable. Coloured dividers for easy classification. Sewn edges. Letter size. Assorted colours.  
AVD A00337 (270272) 6 pockets  
AVD A00330 (270264) 13 pockets  
AVD A00324 (350199) 26 pockets

**G Filexec Expanding File**

Polyvinyl. 13 pockets. Index tabs and inserts. Bungee cord closure. Black.  
VLB 43300 (100693) cheque  
VLB 43200 (100685) letter  
VLB 43100 (100677) legal

**H Expanding File**

Durable polypropylene. 1-1/2 in. expansion. Flap with bungee cord closure.  
**Letter size**  
WNN 321-BE (664573) blue  
WNN 321-CR (711747) clear  
**Legal size**  
WNN 322-BE (664599) blue  
WNN 322-CR (711754) clear



**C** Winnable



**D** FIVE STAR  
★★★★★



**E** FIVE STAR  
★★★★★



**F** ecooffice



**G** vlb

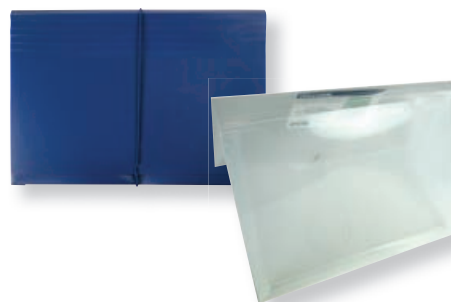

**H** Winnable



## A 2-Pocket Folder

Moisture and tear resistant polyethylene. Front and back pockets.  
Flap with string closure. Letter size.  
**WNN PF-02-DB** (734020) dark blue  
**WNN PF-02-BK** (734038) black

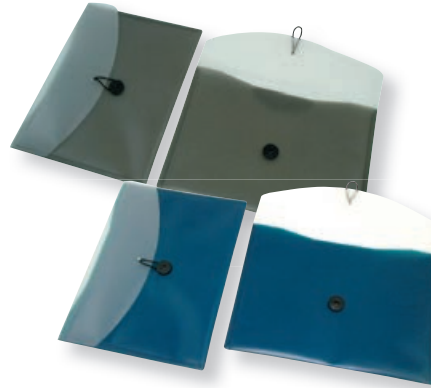

**A** Winnable

## B Step File

Vertical filing system allows you to see all your documents at once.  
4 pockets with index tabs. Fastener. Letter size.  
**WNSF-06-AD** (745992) assorted colours  
**WNSF-01** (734061) black  
**WNN SF-02** (1028489) dark blue  
**WNN SF-04** (1028471) burgundy



**B** Winnable

## C Super Slim Expanding Wallet

12 tabbed pockets. Button closure. Letter size. Assorted colours.  
**VLB AE44260** (420513)

## D Expanding File With Flap

Polyvinyl. 5-1/4 in. expansion. For legal size documents.  
Stitched cloth reinforced edges. Elastic closure. Black.  
**WNN328-BK** (100727)



**C** vlb



**D** Winnable

## E Eco-Friendly Expanding Case File

100% oxo-biodegradable polypropylene. 13 pockets. Sewn edges,  
handles and clear panels. Letter size.  
**AVD A00323** (245597)

## F Expanding File

Durable polypropylene. 1-1/2 in. expansion. Holds up to 200 sheets.  
Elastic corner fasteners. Letter size.  
**WNN 315-BE** (664615) blue  
**WNN 315-BK** (664623) black  
**WNN 315TCR** (691279) clear

## G Eco-Friendly Expanding File

100% oxo-biodegradable polypropylene. Elastic band and button closure.  
Letter size.  
**AVD A00321** (245589) 7 pockets  
**AVD A00320** (245571) 13 pockets



**E** ecooffice



**F** Winnable

## H Swirl Expanding File

Polypropylene. 6 pockets. Top view on flap. Elastic closure.  
Assorted colours.  
**VLB AE94990** (270587)



**G** ecooffice



**H** vlb



**A** **Pendaflex®**



**B** **Pendaflex®**

**A 13-Pocket Expanding Carry Case**

Convenient carry handle with full flap and push button clip. Stitched cloth trim. Tab inserts included. Legal size. Black. **PFX 99787** (218461)

**B Expanding Pocket File**

Polypropylene. 13 pockets. Sliding cover that keeps the flap out of the way when accessing the document. Expanding bottom allows the file to stand on a desktop. Index tabs and labels. Elastic closure. Letter size. Black. **PFX 02327** (120865)

**C Expanding File**

Polyvinyl. 13 pockets. Index tabs and inserts. Stitched cloth reinforced edges. Elastic closure. Black. **WNN 203D13BK** (238857) cheque  
**WNN 201D-13-BK** (755256) letter  
**WNN 202D-13-BK** (772624) legal

**D Expanding File**

Polypropylene. Includes index tabs and inserts. Handle and closure. Legal size. Black. **WNN 150-12BK** (711739) 13 pockets  
**WNN 150-21BK** (186924) 21 pockets

**E Expanding File**

Polyvinyl file features 13 compartments with tabs and inserts. Letter size. Flap with coil binding and elastic tie. **WNN 20122** (142000)

**F Portafile® Portable File**

19 pockets. Reinforced gussets for extra strength. Plastic closure and handle. Fits letter and legal size documents. Preprinted alphabetic and subject headings. 10% post-consumer fibre. **PFX 01156** (631382) black  
**PFX 01157** (631374) purple  
**PFX 01159** (631390) green  
**PFX 01160** (631366) dark turquoise

**G Desk Free Hanging Organizer With Case**

Vertical filing system allows you to see all your documents at once. 6 colour-coded removable pockets with index tabs. Features carry case with handle and secure fastener. **PFX 52891** (620559) letter  
**PFX 52889** (697664) legal

**H 9-Pocket Expanding File**

Zipper closure. 8 tabs with paper inserts Clear front pocket. Letter size. Assorted colours. **WNN 20141** (351395)



**C** **Winnable**



**D** **Winnable**



**E** **Winnable**



**F** **Pendaflex®**



**G** **Pendaflex®**



**H** **Winnable**

## A Rotary Business Card File

Includes sleeves and 24 coated A-Z index tabs. 2-5/8 x 4 in. Black.  
**ROL 67236** (662791) 400 cards  
**ROL66704** (211243) 500 cards

## B Desk Business Card File

350 card capacity. Includes dividers labeled A to Z.  
 Black and smoke.  
**LLR 01028** (1028695)

## C Telindex® Desk Business Card File

500 card capacity. Includes 500 preprinted address cards and 25 A-Z index cards. Black and grey.  
**DBL 2412-01** (552752)

## D Refill Cards

White cardstock. 2-1/4 x 4 in. Package of 100.  
**ROL 67558** (789792) plain  
**ROL 67553** (565341) ruled

## E Index Card Storage Box

For 3 x 5 in. index cards. Capacity of 1,000 cards. Adjustable follower keeps cards upright for easy access. Metal label holder. Made of pressboard.

**3 x 5 in.**  
**OXF 406350** (1028555) white/black  
**OXF 406355** (1028547) blue/black  
**4 x 6 in.**  
**OXF 406462** (1028562) indigo/black

## F Business Card File

Removable transparent lid. Separator from A to Z included. Black.  
**Metal - for 400 cards**  
**ACM 86400** (610832)  
**Plastic - for 600 cards**  
**ACM86600** (560524)



**A** 

**B** 



**C** 

**D** 



**E** 

**F** 



**A** **AVERY**



**B** **mead**

**A White Index Cards for Printer**

For ink jet and laser printers. 65 lb. 3 x 5". Package of 150.  
**AVE 05388** (416115)

**B On the Edge Ruled Index Cards**

3 x 5" white cards with colour edge. 20 each red, yellow, green, orange, blue. Package of 100.  
**HLR 63088** (524819)

**C White Index Cards**

Package of 100. 50% post-consumer fibre.  
**Blank**  
**OXF 30** (646505) 5 x 3"  
**OXF 40** (646521) 6 x 4"  
**OXF 50** (646539) 8 x 5"  
**Ruled on one side**  
**OXF 31** (646513) 5 x 3"  
**OXF41** (646497) 6 x 4"  
**OXF51** (646489) 8 x 5"

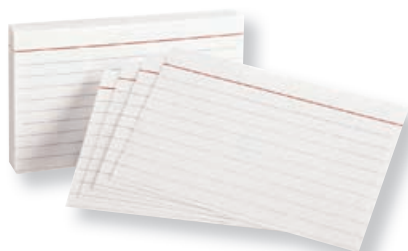

**C** **Oxford**



**D** **Oxford**



**D Coloured Assorted Ruled Index Cards**

Package of 100. 50% post-consumer fibre.  
**OXF 90113** (746008) 3 x 3"  
**OXF 90114** (746016) 4 x 6"  
**OXF 90115** (746024) 5 x 8"

**E Plain Card Guides**

Heavyweight manila stock. 3-position blank tabs. Package of 100. 50% post-consumer fibre.  
**OXF B643** (489047) 6 x 4"  
**OXF B853** (489062) 8 x 5"

**F A-Z Index Card Guide Sets**

Pre-printed A to Z. Extra rigid 15-pt stock. 1/5-cut tabs. Package of 25. Manila.  
**OXF B5325** (224238) 5 x 3"  
**OXF B8525** (1028588) 8 x 5"



**E** **Oxford**



**F** **Oxford**

**G A-Z Card Guides**

Heavyweight manila stock. Laminate reinforced tabs. Buff. 5 x 3". 50% post-consumer fibre.  
**OXF BC5325** (36137)

**H A-Z Assorted Colour Index Card Guide**

Heavyweight manila stock. Laminated tabs. 6 x 4 in. Package of 25.  
**OXF 04635EE** (598797)

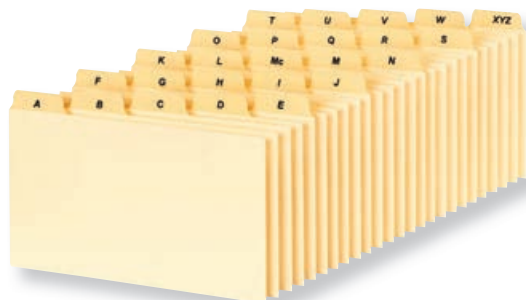

**G** **Oxford**



**H** **Oxford**

## A R-Kive® Recycled Storage Box

Multi-layered corrugate with double bottom, triple end, double side construction offers up to 70% more stacking strength than basic boxes. 100% post-consumer recycled content. SFI certified.  
FEL 12775 (789750)



## B Stor/File™ Earth Series Storage Box

100% post-consumer recycled content. SFI certified.  
FEL 12770 (117762)



## C Stor/File™ Earth Series Storage Box

File folders not included. Reinforced hand holes. 100% post-consumer recycled content. SFI certified.  
FEL 1270101 (117796) letter  
FEL 1270201 (117804) legal



## D Enviro Stor™ Storage Box

100% post-consumer recycled content. FSC® certified.  
FEL 00872 (267559) by each  
FEL00872-05 (656025) pkg 5



## E Enviro-Stor™ Storage Box

100% post-consumer recycled content. FSC® certified.  
FEL00901 (267567) letter  
FEL 00902 (267575) legal  
FEL 00972 (267583) letter/legal



## F Offix® Enviro Storage Box

100% post-consumer recycled content. FSC® Certified.  
NVX 345298 (345298) pkg 10  
NVX 358663 (358663) pkg 25



## G Stor/Drawer® Steel Plus™ Storage File

Multi-wall construction with steel support frame to increase stacking strength. Removable hanging file rails. Plastic handle. 100% post-consumer recycled content. SFI certified.  
FEL 1231101 (117267) letter  
FEL 1231201 (117812) legal



## H Enviro Stor™ Storage File

100% post-consumer recycled content. SFI certified.  
FEL 00202 (6445) cheque  
FEL 00211 (646) letter  
FEL 00212 (212852) legal



	CODE	MANUFACTURER #	INT. DIMENSIONS H x W x D"	SIZE	LID	STACKING CAPACITY	STRENGTH	ASSEMBLY
A	FEL 12775	12775	10 x 12 x 15	letter/legal	removable	800 lb	maximum	Fast Fold
B	FEL 12770	12770	10 x 12 x 15	letter/legal	removable	550 lb	extra	Fast Fold
C	FEL 1270101	1270101	10 x 12 x 24	letter	removable	650 lb	extra	Fast Fold
C	FEL 1270201	1270201	10 x 15 x 24	legal	removable	700 lb	extra	Fast Fold
D	FEL 00872	00872	10-1/4 x 12 x 15	Letter/legal	attached	350 lb	standard	to be assembled
D	FEL 00872-05	00872-05	10-1/4 x 12 x 15	letter/legal	attached	350 lb	standard	to be assembled
E	FEL 00901	00901	10 x 12 x 24	letter	removable	450 lb	standard	to be assembled
E	FEL 00902	00902	10 x 15 x 24	legal	removable	500 lb	standard	to be assembled
E	FEL 00972	00972	10-1/4 x 12 x 15-1/4	letter/legal	removable	350 lb	standard	to be assembled
F	NVX 345298	6007201	10 x 12 x 15	letter/legal	attached	350 lb	standard	to be assembled
F	NVX 358663	6007202	10 x 12 x 15	letter/legal	attached	350 lb	standard	to be assembled
G	FEL 1231101	1231101	12-1/2 x 24-1/4 x 10-3/8	letter	shell	5 boxes	extra	Fast Fold
G	FEL 1231201	1231201	15-1/2 x 24-1/4 x 10-3/8	legal	shell	5 boxes	extra	Fast Fold
H	FEL 00202	00202	9 x 24 x 4-1/2	cheque	shell	2 boxes	standard	Fast Fold
H	FEL 00211	00211	12-1/2 x 24 x 10-1/2	letter	shell	2 boxes	standard	Fast Fold
H	FEL 00212	00212	15-1/2 x 24 x 10-1/2	legal	shell	2 boxes	standard	Fast Fold

**FAST FOLD: ONE-STEP QUICK ASSEMBLY.**

 <p><b>A</b>  </p>	 <p><b>B</b>  </p>	<p><b>A Presto™ Storage Box</b> 85% stronger than basic boxes. Double bottom, double end and double side construction. 60% recycled content, 50% post-consumer. SFI certified. <b>Sold by each</b> <b>FEL0063101</b> (789719) letter <b>FEL0063201</b> (789727) legal <b>FEL0063601</b> (789735) lettre/légal <b>Package of 4</b> <b>FEL0063602</b> (547489) lettre/légal</p>
 <p><b>C</b>  </p>	 <p><b>D</b>  </p>	<p><b>B Binderbox™ Storage Box</b> Double-layer bottom. Deep enough to store 8 full 2 in. binders. 60% recycled content, 50% post-consumer. SFI certified. <b>FEL 0073301</b> (755165)</p> <p><b>C Stor/File™ DividerBox™ Storage Box</b> Removable corrugated box dividers with 3 compartments. 60% recycled content, 50% post-consumer. SFI certified. <b>FEL 0083601</b> (141838)</p>
 <p><b>E</b>  </p>	 <p><b>F</b>  </p>	<p><b>D Stor/File™ Storage Box</b> File folders not included. 60% recycled content, 50% post-consumer. SFI certified. <b>FEL 00701</b> (323675) letter <b>FEL 00702</b> (415596) legal</p> <p><b>E Hang'N'Stor™ Storage Box</b> Perfect for hanging file folders storage. Depth of 16 in. Hanging files are supported by plastic channels attached to the inside of the box. Package of 4. 60% recycled content, 50% post-consumer. SFI certified. <b>FEL 00785</b> (821314)</p> <p><b>F Quick/Stor™ Storage Box</b> Folders not included. 50% post-consumer recycled content. SFI certified. <b>FEL 0078925</b> (491191)</p>
 <p><b>G</b>  </p>	<p><b>G Stor/File™ Storage Box</b> 60% recycled content, 50% post-consumer. SFI certified. <b>Sold by each</b> <b>FEL 00772</b> (6635) <b>Package of 6 boxes</b> <b>FEL07727</b> (562801)</p>	

	CODE	MANUFACTURER #	INT. DIMENSIONS H x W x D"	SIZE	LID	STACKING CAPACITY	STRENGTH	ASSEMBLY
A	FEL 0063101	0063101	10 x 12 x 24	letter	removable	750 lb	maximum	To be assembled
A	FEL 0063201	0063201	10 x 15 x 24	legal	removable	800 lb	maximum	To be assembled
A	FEL 0063601 / FEL 0063602	789735/545489	10 x 12 x 15	letter/legal	removable	850 lb	maximum	To be assembled
B	FEL 0073301	0073301	12 x 12-1/4 x 18-1/2	letter/legal	removable	850 lb	maximum	Fast Fold
C	FEL 0083601	0083601	10 x 12 x 15	letter	removable	850 lb	maximum	Fast Fold
D	FEL 00701	00701	10 x 12 x 24	letter	removable	650 lb	extra	Fast Fold
D	FEL 00702	00702	10 x 15 x 24	legal	removable	700 lb	extra	Fast Fold
E	FEL 00785	00785	10 x 12 3/8 x 15 3/4	letter/legal	removable	350 lb	extra	Fast Fold
F	FEL 0078925	00789-25	10-1/4 x 12 x 15-1/2	letter/legal	removable	550 lb	extra	to be assembled
G	FEL 00772 / FEL 07727	6635/562801	10 x 12 x 15	letter/legal	removable	450 lb	standard	to be assembled

FAST FOLD: ONE-STEP QUICK ASSEMBLY.

## A R-Kive® Storage Box

59% post-consumer recycled content.  
**FEL 00724** (713602) white/black  
**FEL 00725** (212910) woodgrain  
**FEL 07241** (713610) white/green  
**FEL 07242** (713628) white/red  
**FEL 07243** (713636) white/blue

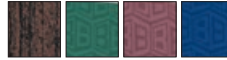

## B Stor/File EasyLift Storage Box

Compact size - 20% lighter than a standard letter size box.  
 60% recycled content. SFI certified.  
**FEL 0006301** (117770)

## C Offix® Letter/Legal Storage Box

60% recycled content. 50% post-consumer.  
**NVX 345272** (345272) by each  
**NVX 345280** (345280) pkg 6

## D Offix® Reinforced Storage Box

Reinforced sides. Package of 10 boxes. 50% post-consumer recycled content.  
**NVX 345322** (345322)

## E Stor/Drawer® Steel Plus™ Storage File

Hanging folder rails included. 60% recycled content, 50% post-consumer. SFI certified.  
**FEL 00311** (126854) letter  
**FEL 00312** (126870) legal

## F File/Cube Storage Box Shell

Keeps files accessible during temporary storage. Clip together vertically and horizontally for stability. Steel support frame. Package of 6.  
 60% recycled content, 50% post-consumer waste. SFI certified.  
**FEL 0162601** (821322)



	CODE	MANUFACTURER #	INT. DIMENSIONS H x W x D"	SIZE	LID	STACKING CAPACITY	STRENGTH	ASSEMBLY
A	FEL 00725	725	10 x 12 x 15	letter/legal	removable	850 lb	maximum	Fast Fold
A	FEL 00724	724	10 x 12 x 15	letter/legal	removable	850 lb	maximum	Fast Fold
A	FEL 07241	7241	10 x 12 x 15	letter/legal	removable	850 lb	maximum	Fast Fold
A	FEL 07242	7242	10 x 12 x 15	letter/legal	removable	850 lb	maximum	Fast Fold
A	FEL 07243	7243	10 x 12 x 15	letter/legal	removable	850 lb	maximum	Fast Fold
B	FEL 0006301	6301	10 x 12 x 12	letter	removable	400 lb	standard	to be assembled
C	NVX 345272	6007101	10 x 12 x 15	letter/legal	removable	350 lb	standard	to be assembled
C	NVX 345280	6007102	10 x 12 x 15	letter/legal	removable	350 lb	standard	to be assembled
D	NVX 345322	6007401	10-1/4 x 12 x 15	letter/legal	removable	850 lb	maximum	to be assembled
E	FEL 00311	311	12-1/2 x 24-1/4 x 10-3/8	letter	shell	5 boxes	maximum	to be assembled
E	FEL 00312	312	15-1/2 x 24-1/4 x 10-3/8	legal	shell	5 boxes	maximum	to be assembled
F	FEL 0162601	162601	10 x 12 x 15	letter/legal	shell	5 boxes	maximum	to be assembled

FAST FOLD: ONE-STEP QUICK ASSEMBLY.



**A Binding Case**

Self contained arch files hold loose papers for shelf access, archive storage or transporting. Identification label on back. Package of 6. 100% recycled content, 85% post-consumer waste.

**Note size, 12-1/2 x 3-1/2 x 7-1/8"**

**ACC14084** (162255)

**Invoice size, 10-1/4 x 3-1/2 x 9"**

**ACC14054** (162248)

**Letter size, 12-1/2 x 3-1/2 x 9"**

**ACC 14064** (661199)

**Legal size, 15-1/2 x 3-1/2 x 9-1/4"**

**ACC14074** (661173)

**Prescription size, 8-3/8 x 3-1/2 x 5-1/8"**

**ACC14094** (162263)

**B Offix® Binding Case**

With arch and identification label on back. Package of 6. 100% recycled content, 85% post-consumer material.

**Letter size, 12-1/2 x 3-1/2 x 9-1/4"**

**NVX 345181** (345181)

**Legal size, 15-1/2 x 3-1/2 x 9-1/4"**

**NVX 345199** (345199)

**C Transfer File**

Walnut finish cardboard. Designed with hinged lid and 4" front flap. Reinforced corners and edges. Legal size, 15-1/2 x 5 x 10-1/4". 10% post-consumer fibre.

**GLW 492WA** (3772)



**D Staxonsteel® Storage File**

Double-layered corrugated board. Steel structure. Metal railing for more stability. Can stack up to 10 boxes high. 60% recycled content, 50% post-consumer waste. SFI certified.

**Letter size, 12-1/4 x 24 x 10-1/2"H**

**FEL 00511** (212886)

**Legal size, 15-1/4 x 24 x 10-1/2"H**

**FEL00512** (6528)

**E Storage File**

For hanging folders filing, letter or legal size. Stackable. Built-in key lock. 12-1/4 x 14-7/8 x 18-1/8"H.

**STX 61251B02C** (695320) grey

**STX 61260B02C** (186874) black

**F Storage Drawer**

Storage for hanging folders. Can stack up to 10 boxes high. Black and grey.

**Letter size, 24-5/8 x 15 x 11-3/8"H**

**STX 61106B01C** (765107)

**Legal size, with lock, 24-1/4 x 18-1/4 x 11-3/8"H**

**STX61402B01C** (765131)

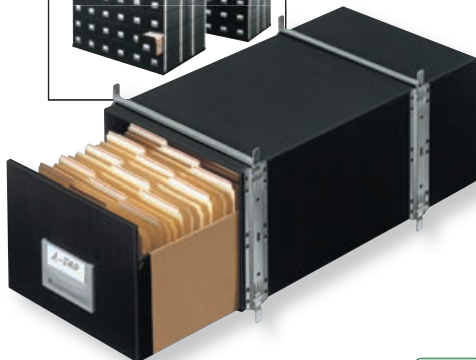
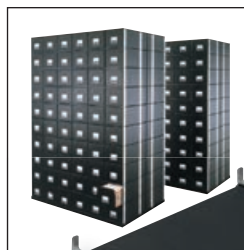



## A Portable File Tote

Accommodates both letter and legal hanging files and folders. Moisture resistant. Lid snaps on securely. 18-3/8 x 13-7/8 x 10-1/2 in.

### Snap-on lid

STX 61508B04C (829707) clear

STX 61528B04C (829708) black

### Locking handles

STX 61530B04C (829709) clear

STX 61543B04C (829710) black



## B Storage Tote With Lid

Folding lid allows for a quick peek inside. Made from an impact resistant plastic. 60 litre capacity. Black/clear.

STX 00900U04C (428011)

## C Storage Box

Plastic. Lightweight and stackable. No lid. For letter/legal filing. Black with white handles.

STX 61788U03C (829711)

## D Folding Storage Box

Plastic. Folds to 3 in. thick when not in use. For letter/legal filing. Black.

STX 61809U04C (829712)

## E Stackable Storage Box

Plastic box with clear lid. Two latches secure lid in place. For letter/legal filing. Stackable in any direction with the cover on. Exterior dimension 17-1/4 x 14-1/4 x 10-1/2 in. H. 25% post-consumer waste.

STX 62005S03C (279232)

## F Heavy-Duty Plastic Portable File Box

Fits letter and legal sized files. Utilizes integrated hanging rail. Top lid with quick access compartments. Reinforced corners. Stackable. Comfortable handle for easy transport. 14 1/4 x 8 5/8 x 11 1/8 in. H.

FEL 0086207 (832970)

## G Mesh Collapsible File Box

Convenient, portable file made of black steel mesh. Integrated handles. Collapsible for compact storage when not in use. Black.

15 x 13 x 9-1/2 in. H.

WNN 15309 (277004)



Folding



Folding



**N**  
2023

5.5L  
5.5L  
10L  
18.5L  
5.5L  
5.5L  
10L  
36L  
85L

**A** **BANKERS BOX** \*Dimensions available online

**B** **cep**

**A Storage Box Set**

Made from impact resistant polypropylene that is fully recyclable. Stackable. Double reinforced base and corners. Protects from dust and moisture. Clip-lock clamps securely lock the lid. 100% BPA free.

**Set of 3 boxes - 10 L (X2) + 18.5 L**  
FEL 7731502 (832966)

**Set of 4 boxes - 5.5 L (X2) + 10 L + 18.5 L**  
FEL 7731702 (832965)

**Set of 5 boxes - 5.5 L (X2) + 10 L + 36 L + 85 L**  
FEL 7731903 (832967)

**Set of 3 boxes - 70 L + 85 L (X2)**  
FEL 7731202 (832968)

**B Strata Plastic Storage Box**

Translucent plastic. Easy access lids that clip on each side of the centre and open from each end without removing entire lid. Roll-up locking handles snap into place.

**1.7 litres, 5-1/4 x 7-3/4 x 4-1/4 in. H**  
GRN STRATA17L (1028042)

**6 litres, 6-1/2 x 9-1/8 x 6-5/8 in. H**  
GRN STRATA6L (166124)

**12 litres, 16 x 11-1/4 x 7-1/4 in. H**  
GRN STRATA12L (166132)

**20 litres with side opening, 18 x 14 x 7-1/4 in. H**  
GRN STRATA20L (370577)

**40 litres, 19-1/2 x 15-1/4 x 13 in. H**  
GRN STRATA40L (230086)

**75 litres with wheels, 23-1/2 x 19 x 16 in. H**  
GRN STRATA75L (370585)

**C** **BANKERS BOX**

**N**  
2023

**C Heavy-Duty Plastic Bin**

Fits letter and legal sized files. Utilizes integrated hanging rail. Reinforced corners. Stackable. Comfortable side handles.

14 1/8 x 17 3/8 x 10 5/8 in. H. 29 L.  
FEL 0086302 (832969)

**D Portable File Box**

Rigid plastic. With soft grip handle. Perforation for lock. For letter or legal size. 17-1/8 x 9-5/8 x 11 in. H. 25% post-consumer waste.

**STX 61510B04C (797142) black**  
**STX61511B04C (141416) white**

**D** **STOREX**  

**E** **STOREX**  

**E Portable File Box With Extra Storage**

Rigid plastic. Extra large clear lid with compartments to store all of your needed supplies. Latch clamps shuts to provide a secure closure. Accepts a padlock. Letter size. Exterior dimension 14-7/8 x 12-3/4 x 11 in. H. Black. 25% post-consumer waste.

**STX 61504B03C (279216)**

**F Premium Mobile Portable File Box**

Rigid plastic. On wheels. Push button telescopic handle. For letter size. Organizer in cover. Accessories not included. Black. 12-3/4 x 15 x 11 in. H. 25% post-consumer waste.

**STX 61507B01C (797134)**

**F** **STOREX**  

**G** **SAFCO**

**G STOW AWAY® Mobile Crate**

Efficiently transports files, binders, tools safe and secure. Fold down to 3-1/2 in. thick. Provides 1.2 cubic feet and 50 lb capacity.

16-1/2 x 14-1/2 x 18 in. H. Black.  
**SAF 4054BL (238840)**

## A Onyx™ Rolling File Cube

Tubular steel mesh frame with powder coat finish. Stores neatly under desk or work surface. Holds letter-size documents. Four swivel wheels (two locking) 16-3/4 x 13-1/2 x 13 in. H. Black.  
SAF 5211BL (832688)



## B Mobile File Cart

Sturdy steel wire construction. Accommodates letter/legal files. Bottom shelf. On casters, 2 locking. Black scratch-resistant powder coat finish.

**1 level - 15-1/2 x 14 x 19-3/4 in.**

SAF 5277BL (789818)

**2 levels - 25-3/4 x 13-7/8 x 29-3/4 in.**

SAF 5278BL (773762)



## C Onyx™ Mesh File Cart

Tubular steel mesh frame. Top shelf stores additional supplies. Black powder coat finish for durability. Four swivel casters (two locking). 15-3/4 x 17 x 27 in. H. Black.

**Open file and 2 drawers**

SAF 5215BL (238428)

**File drawer and 2 drawers**

SAF 5213BL (134098)

**4 drawers**

SAF 5214BL (320523)



## D Scoot™ Mobile File

Contemporary look. For letter or legal size file folders. Additional pockets on each end. On casters, 2 locking. 28 x 14-1/2 x 27"H. Black and silver.

SAF 5373BL (773770) open

SAF 5370BL (564716) covered

## E Mobile File Cart

Sturdy steel construction. Letter or legal filing. Bottom shelf. On casters, 2 locking. 12.9 x 25.8 x 20.5 in.H. Scratch-resistant, powder-coat finish. Black.

**1 level - 12.9 x 25.8 x 20.5 in.**

LLR 45651 (1027507)

**2 levels - 26 x 12-1/2 x 30 in.**

LLR 45650 (1027499)



## F Mesh Rolling File

Holds letter-size, hanging file folders. Perforated steel frame. Bottom shelf. On casters. 12-1/2 x 25 x 28-1/4 in. H. Black.  
LLR 60175 (1055319)





# Efficiency

Workers want the right tools for the job. In this section you will find all the necessary office tools to match each worker's individual task and increase productivity while reducing stress.

# WORKPLACE ESSENTIALS

---

## BINDERS AND ACCESSORIES

Binders .....	501
Binder Accessories .....	510
Tab Dividers .....	512
Sheet Protectors .....	520
Report Covers .....	524
Clipboards and Form Holders .....	532

---

## SMALL OFFICE TOOLS

Staplers .....	536
Hole Punches .....	545
Measuring and Drafting Tools .....	549
Magnifiers .....	551
Cutting and Sharpening Tools .....	552
Keys and Locks .....	561

---

## OFFICE SUPPLIES

Glues .....	565
Wall Mounting Products .....	567
Adhesive Tape .....	570
Fasteners and Rubber Bands .....	573
Clips .....	576

---

## STAMPS

Custom Stamps .....	579
Stamps and Daters .....	581
Stamp Ink and Accessories .....	585

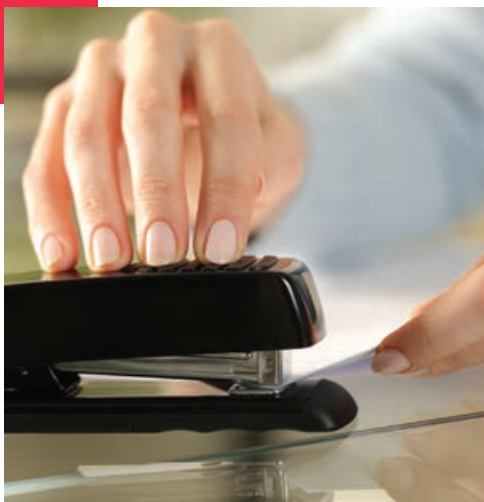

# REPORT COVERS



- Made of heavy duty laminated paper
- Available in 3 different versions :
  - with pockets and fasteners,
  - fasteners only
  - pockets only
- Available in 13 colors

#34000, #34200, #34400

- Made of heavy-duty plastic
- Many different versions availables
- Available in 4 colors

#PFDT, #PFDT2, #PFDTST,  
#PFPL2 et #PFPL2ST



# PRESENTATION BINDERS



- Presentation pockets on every side
- 2 inside pockets
- D-shaped rings
- 1 in and 1.5 in
- Available in 6 colors

#CV10 et #CV15



## A QuickFit® Heavy-Duty Binder

Space saving design. Double hinged cover, takes less space on a shelf. Commercial grade PVC free polypropylene material. Easy to load D rings. Spine label holder. Inside pockets. 100% recycled board with 85%+ post-consumer waste. Black.

- RG0 29011** (561811) 1 in.
- RG029021** (561829) 1-1/2 in.
- RG0 29031** (561837) 2 in.
- RG0 29051** (561845) 3 in.
- RG0 29061** (561852) 4 in.
- RG0 29071** (561860) 5 in.



**A** QuickFit

## B Deluxe QuickFit® Heavy-Duty File Binder

Space-saving design, double hinged cover takes up less space on shelf. Wrap-around, one-piece label holder. Easy to load D rings. Clear interior pocket on front and back covers. No ink transfer. Heavy-gauge grained polypropylene. PVC free. 4 in. and 5 in. sizes have locking rings. 100% recycled (90% PCW) solid board.

**White**

- RG0 28030** (197079) 2 in.
- RG0 28050** (197095) 3 in.
- RG0 28060** (197111) 4 in.
- RG0 28070** (197152) 5 in.

**Black**

- RG0 28031** (197087) 2 in.
- RG0 28051** (197103) 3 in.
- RG0 28061** (197129) 4 in.
- RG0 28071** (197160) 5 in.



**B** QuickFit

## C QuickFit® PRO Single Touch Heavy-Duty Binder

Space-saving design, double hinged cover takes up less space on shelf. Wrap-around, one-piece label holder. Pin-Lock® single-touch D rings make it easy to load. Clear interior pocket on front and back covers. No ink transfer. Heavy-gauge polypropylene. PVC free.

**White**

- RG0 90010** (534867) 1 in.
- RG0 90020** (547232) 1-1/2 in.
- RG0 90030** (561894) 2 in.
- RG0 90050** (561902) 3 in.
- RG0 90060** (523415) 4 in.
- RG090070** (523423) 5 in.

**Black**

- RG090011** (1003698) 1 in.
- RG090021** (1003706) 1-1/2 in.
- RG090031** (1003714) 2 in.
- RG090051** (1003722) 3 in.
- RG090061** (1003730) 4 in.
- RG090071** (1003748) 5 in.



**C** QuickFit

## D XtraLife® ClearVue® Locking Slant-D® Binders

Resists cracking along the seam for long lasting durability. Slanted rings hold more sheets than standard D rings. Unique polyolefin cover material endures extreme temperatures. Clear non-stick clear overlay on 3 sides.

**White**

- CRD26300** (1035170) 1 in.
- CRD 26320** (1035220) 2 in.
- CRD 26330** (1035238) 3 in.
- CRD 26340** (1035246) 4 in.
- CRD 26360** (1035261) 6 in.

**Black**

- CRD26301** (1034149) 1 in.
- CRD 26311** (1034206) 1-1/2 in.
- CRD 26321** (1034164) 2 in.
- CRD 26331** (1034180) 3 in.
- CRD 26341** (1036367) 4 in.
- CRD26351** (1036375) 5 in.
- CRD 26361** (1035254) 6 in.

**Blue**

- CRD26302** (1034157) 1 in.
- CRD26312** (1034214) 1-1/2 in.
- CRD 26322** (1034172) 2 in.
- CRD 26332** (1034198) 3 in.



**D** Cardinal



**A** BUSINESS SOURCE®

**A Heavy-Duty View Binder**

No-gap round rings. Cover and pocket material resists ink transfer. Two interior pockets.

**White**

- BSN 19551 (1034313) 1/2 in.
- BSN 19601 (1034347) 1 in.
- BSN19651 (1034370) 1-1/2 in.
- BSN19701 (1034404) 2 in.
- BSN 19751 (1034438) 3 in.

**Black**

- BSN19550 (1034297) 1/2 in.
- BSN 19600 (1034321) 1 in.
- BSN 19650 (1034355) 1-1/2 in.
- BSN 68020 (1034388) 2 in.
- BSN 19750 (1034412) 3 in.

**Blue**

- BSN19552 (1034305) 1/2 in.
- BSN19602 (1034339) 1 in.
- BSN 19652 (1034362) 1-1/2 in.
- BSN01642 (1034396) 2 in.
- BSN 19752 (1034420) 3 in.

**B One Touch™ Heavy-Duty Ring Binder**

One Touch™ Locking D rings open with ease and keep pages secure. Gap Free ring prevents gapping and misalignment of rings. Letter size. Label on spine. 2 stacked inside pockets on each side. Black.

- AVE 79-990 (560821) 1 in.
- AVE79-991 (560839) 1-1/2 in.
- AVE79-992 (738930) 2 in.
- AVE 79-993 (560847) 3 in.
- AVE 79-994 (288159) 4 in.
- AVE79-996 (1035980) 5 in.



**B** AVERY

**C Heavy-Duty Binder**

Slant D-ring. No-gap rings are back-mounted so pages lie flat; stay tightly closed without gaps. Utility pocket inside front cover and double opening/closing boosters. For 8-1/2 x 11 in. documents.

**Black**

- BSN33105 (1036516) 1 in.
- BSN 33125 (1034644) 1-1/2 in.
- BSN 33109 (1035642) 2 in.
- BSN 33113 (1035634) 3 in.
- BSN33117 (1035650) 4 in.
- BSN33121 (1035667) 5 in.

**Blue**

- BSN 33107 (1035725) 1 in.
- BSN 33127 (1034636) 1-1/2 in.
- BSN 33111 (1035733) 2 in.
- BSN33115 (1035676) 3 in.
- BSN33119 (1035741) 4 in.

**Burgundy**

- BSN 33106 (1035683) 1 in.
- BSN 33126 (1034628) 1-1/2 in.
- BSN 33110 (1035691) 2 in.
- BSN33114 (1035709) 3 in.
- BSN33118 (1035717) 4 in.

**Red**

- BSN 33108 (1035759) 1 in.
- BSN 33128 (1034652) 1-1/2 in.
- BSN 33112 (1035766) 2 in.
- BSN33116 (1035774) 3 in.
- BSN33120 (1035782) 4 in.



**C** BUSINESS SOURCE®



## A Durable View Binder

Customize the cover and spine. Slant D-rings.

### White

- AVE34075 (428680) 1/2 in.
- AVE 34002 (561142) 1 in.
- AVE 17022 (561092) 1-1/2 in.
- AVE 17032 (561100) 2 in.
- AVE 17042 (428672) 3 in.

### Black

- AVE34001 (597328) 1/2 in.
- AVE 34003 (597310) 1 in.
- AVE 17021 (597278) 1-1/2 in.
- AVE 17031 (597252) 2 in.
- AVE17041 (597336) 3 in.



## B One Touch™ Heavy Duty Binder

Heavy duty non stick poly construction for maximum performance. One Touch™ D rings open and lock close with easily. Four inside pockets. Wider front and back panels cover standard size dividers and sheet protectors. Letter size.

### White

- AVE79-795 (716811) 1-1/2 in.
- AVE79-792 (716795) 2 in.
- AVE79-793 (716803) 3 in.
- AVE79-704 (716829) 4 in.

### Black

- AVE79-692 (1034248) 2 in.
- AVE 79-693 (1034256) 3 in.
- AVE 79-604 (1034263) 4 in.

### Blue

- AVE 79772 (440610) 1 in.
- AVE 79775 (440644) 1-1/2 in.
- AVE79778 (1035311) 2 in.

### Green

- AVE79770 (440594) 1 in.

### Purple

- AVE 79771 (440602) 1 in.
- AVE 79774 (440636) 1-1/2 in.
- AVE 79777 (1035329) 2 in.



## C Heavy-Duty Easy Open™ View Binder

D-rings. Open and close with one simple motion. Made with PVC-free transfer-safe polypropylene. Clear non-stick clear overlay. 4 stacked interior pockets.

### White

- BSN 26955 (1036037) 1 in.
- BSN 26957 (1036011) 1-1/2 in.
- BSN 26959 (1036053) 2 in.
- BSN 26961 (1036078) 3 in.
- BSN 26963 (1036094) 4 in.

### Black

- BSN 26956 (1036029) 1 in.
- BSN 26958 (1036003) 1-1/2 in.
- BSN 26960 (1036045) 2 in.
- BSN 26962 (1036060) 3 in.
- BSN 26964 (1036086) 4 in.





**A Round Ring Essential Binder**

PVC FREE binder. Features clear interior pocket on front and back covers to secure loose documents and allow for easy identification of content. Full width label holder on spine.

- 5/8 in.
- RG0230001** (209270) black
- RG0 230003** (209296) red
- RG0230004** (1035858) green
- 1 in.
- RG0 231100** (523233) white
- RG0231101** (546465) black
- RG0231103** (544346) red
- RG0231104** (544965) green
- RG0 231105** (523241) yellow
- RG0231107** (828079) grey
- RG0231108** (595850) burgundy
- RG0231152** (828080) turquoise
- RG0 231192** (523258) royal blue
- 1-1/2 in.
- RG0231200** (544940) white
- RG0 231201** (523266) black
- RG0 231203** (523274) red
- RG0231204** (534685) green
- RG0231205** (523282) yellow
- RG0231207** (828081) grey
- RG0231208** (523290) burgundy
- RG0231252** (828082) turquoise
- RG0231292** (534743) royal blue
- 2 in.
- RG0 231300** (530881) white
- RG0 231301** (544932) black
- RG0231303** (523308) red
- RG0231304** (534693) green
- RG0231305** (534701) yellow
- RG0231307** (828083) grey
- RG0 231308** (595868) burgundy
- RG0231352** (828084) turquoise
- RG0 231392** (544957) royal blue
- 3 in.
- RG0 231401** (544981) black
- RG0231403** (534727) red
- RG0231404** (523316) green
- RG0 231492** (545145) royal blue



**B Round Ring Binder**

Round ring binders. PVC free polypropylene. 2 interior pockets. For 8-1/2 x 11 in. documents.

- Black**
- BSN 28526** (1035469) 1/2 in.
- BSN09976** (1035543) 1 in.
- BSN 28552** (1035824) 1-1/2 in.
- BSN09977** (1035551) 2 in.
- BSN09978** (1035790) 3 in.
- Blue**
- BSN28525** (1035477) 1/2 in.
- BSN 09975** (1035600) 1 in.
- BSN28551** (1035832) 1-1/2 in.
- BSN 16464** (1034586) 2 in.
- BSN 28661** (1035535) 3 in.
- Red**
- BSN28527** (1035485) 1/2 in.
- BSN28550** (1035816) 1 in.
- BSN28553** (1035840) 1-1/2 in.
- BSN28660** (1035452) 2 in.
- Green**
- BSN28770** (1035808) 1/2 in.
- BSN28556** (1035501) 1 in.
- BSN28557** (1035519) 1-1/2 in.
- BSN28558** (1035527) 2 in.



**D Offix® Binders**

0-ring binders. PVC free polypropylene. Label holder on spine. 2 interior pockets. Solid board is made from 100% recycled content.

- 2 in.
- NVX 346395** (346395) black
- NVX 346403** (346403) blue
- NVX 346411** (346411) green
- NVX 346429** (346429) red
- 3 in.
- NVX 346437** (346437) black
- NVX 346445** (346445) blue
- NVX 346452** (346452) green
- NVX 346460** (346460) red

- 1 in.
- NVX 346312** (346312) black
- NVX 346320** (346320) blue
- NVX 346338** (346338) green
- NVX 346346** (346346) red
- 1-1/2 in.
- NVX 346353** (346353) black
- NVX 346361** (346361) blue
- NVX 346379** (346379) green
- NVX 346387** (346387) red

**C Binder With Label Holder**

Round ring binders. PVC free polypropylene. Label holder on spine. 2 interior pockets. Black.

- BSN 28559** (1035568) 1 in.
- BSN 28560** (1035576) 1-1/2 in.
- BSN 28561** (1035584) 2 in.
- BSN 28562** (1035592) 3 in.

## A D-Ring Binder

Letter size. Label holder on spine. Double triggers. 2 inside pockets. PVC free.

- 1 in.**  
**RG0230100** (1035964) white  
**RG0 230101** (523134) black  
**RG0 230192** (523159) royal blue  
**RG0 230103** (523142) red  
**1-1/2 in.**  
**RG0230200** (1035972) white  
**RG0 230201** (534768) black  
**RG0 230292** (534792) royal blue  
**RG0 230203** (534776) red  
**2 in.**  
**RG0 230400** (523175) white  
**RG0230401** (544916) black  
**RG0 230492** (523209) royal blue  
**RG0 230403** (523183) red  
**3 in.**  
**RG0 230500** (545061) white  
**RG0 230501** (545657) black  
**RG0230592** (523225) royal blue  
**RG0230503** (523217) red

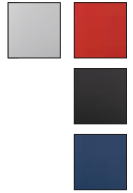

## B Ring Binder

Slanted D rings. Clear inside pockets. Full-width label on spine. Assorted colours.

- RG0 23061-6** (584110) 1 in.  
**RG0 23062-6** (584102) 1-1/2 in.  
**RG0 23064-6** (584094) 2 in.



## C Ring Binder

Vinyl. D rings. Clear pockets on front, spine and back. 2 pockets includes inside.

- 1 in.**  
**GCI CV10LBE** (225094) light blue  
**GCI CV10LGN** (225110) light green  
**GCI CV10OR** (225169) orange  
**GCI CV10PK** (225177) pink  
**GCI CV10RD** (225185) red  
**1-1/2 in.**  
**GCI CV15LBE** (225193) light blue  
**GCI CV15LGN** (225201) light green  
**GCI CV15OR** (225219) orange  
**GCI CV15PK** (225227) pink  
**GCI CV15RD** (225235) red



## D GeoRing Ring Binder

Textured thick polypropylene. D rings. PVC free. Double triggers. Letter size. Label holder on spine. Hole on the spine allows to pull with a finger.

- 1 in.**  
**GCI PGR1410LBE** (238956) light blue  
**GCI PGR1410BE** (266593) blue  
**GCI PGR1410BK** (266601) black  
**GCI PGR1410GN** (239012) green  
**GCI PGR1410OR** (238972) orange  
**GCI PGR1410PE** (805657) purple  
**GCI PGR1410PK** (238998) pink  
**GCI PGR1410RD** (239004) red  
**GCI PGR1410YE** (238964) yellow  
**1-1/2 in.**  
**GCI PGR1415BE** (266643) blue  
**GCI PGR1415BK** (266650) black  
**GCI PGR1415GN** (239087) green  
**GCI PGR1415LBE** (239020) light blue  
**GCI PGR1415OR** (239038) orange  
**GCI PGR1415PE** (805664) purple  
**GCI PGR1415PK** (239061) pink  
**GCI PGR1415RD** (239079) red  
**GCI PGR1415YE** (239046) yellow  
**2 in.**  
**GCI PGR1420BE** (266668) blue  
**GCI PGR1420BK** (266676) black  
**GCI PGR1420GN** (239145) green  
**GCI PGR1420LBE** (239095) light blue  
**GCI PGR1420OR** (239103) orange  
**GCI PGR1420PE** (805672) purple  
**GCI PGR1420PK** (239129) pink  
**GCI PGR1420RD** (239137) red  
**GCI PGR1420YE** (239111) yellow



## E Offix® Ring Binder

D-ring binders. PVC free polypropylene. Label holder on spine. 2 interior pockets. Solid board is made from 100% recycled material.

- 1 in.**  
**NVX 346478** (346478) black  
**NVX 346486** (346486) blue  
**NVX 346494** (346494) green  
**NVX 346502** (346502) red  
**1-1/2 in.**  
**NVX 346510** (346510) black  
**NVX 346528** (346528) blue  
**NVX 346536** (346536) green  
**NVX 346544** (346544) red

- 2 in.**  
**NVX 346551** (346551) black  
**NVX 346569** (346569) blue  
**NVX 346577** (346577) green  
**NVX 346585** (346585) red  
**3 in.**  
**NVX 346593** (346593) black  
**NVX 346601** (346601) blue  
**NVX 346619** (346619) green  
**NVX 346627** (346627) red



**A QuickFit**



**A QuickFit® Presentation Binder**

Polypropylene. PVC free. Round rings. Letter size. Overlay design allows for one-piece insert for cover and spine. 2 clear pockets. No ink transfer from printed material. 100% recycled content, 85+% post-consumer waste.

- White**  
**RG0 870000** (208843) 5/8 in.  
**RG0 871100** (631440) 1 in.  
**RG0 871200** (631457) 1-1/2 in.  
**RG0 871300** (631465) 2 in.  
**RG0 871400** (631473) 3 in.  
**Black**  
**RG0 870001** (233924) 5/8 in.  
**RG0 871101** (234005) 1 in.  
**RG0 871201** (234013) 1-1/2 in.  
**RG0 871301** (234021) 2 in.  
**RG0 871401** (234039) 3 in.



**B offix**



**C BUSINESS SOURCE**

**B Offix® Presentation Binders**

0-ring binders. PVC free polypropylene. Clear overlay on front and back covers and spine. Will not transfer ink from printed material. 2 interior pockets. Solid board is made of 100% recycled content. 1/2 in.

- NVX345926** (345926) white  
**NVX345934** (345934) black  
**1 in.**  
**NVX 345942** (345942) white  
**NVX 345959** (345959) black  
**NVX 345967** (345967) blue  
**NVX 345975** (345975) red  
**NVX 345983** (345983) green  
**1-1/2 in.**  
**NVX345991** (345991) white  
**NVX 346007** (346007) black  
**NVX 346015** (346015) blue  
**NVX 346023** (346023) red  
**NVX 346031** (346031) green  
**2 in.**  
**NVX 346049** (346049) white  
**NVX 346056** (346056) black  
**NVX 346064** (346064) blue  
**NVX 346072** (346072) red  
**NVX 346080** (346080) green  
**3 in.**  
**NVX 346098** (346098) white  
**NVX 346106** (346106) black  
**NVX 346114** (346114) blue  
**NVX 346122** (346122) red



**D AVERY**

**E vlb**

**C Presentation Round Ring View Binder**

Non-stick clear overlay. 2 interior pockets. Open and close triggers. Back mounted rings. For 8-1/2 x 11 in. documents.

- White**  
**BSN09951** (1034891) 1/2 in.  
**BSN09953** (1034933) 1 in.  
**BSN 09955** (1034917) 1-1/2 in.  
**BSN 09957** (1034959) 2 in.  
**BSN 09959** (1034974) 3 in.  
**Black**  
**BSN09950** (1034883) 1/2 in.  
**BSN09952** (1034925) 1 in.  
**BSN 09954** (1034909) 1-1/2 in.  
**BSN 09956** (1034941) 2 in.  
**BSN 09958** (1034966) 3 in.  
**Red**  
**BSN 09965** (1034743) 1/2 in.  
**BSN 09966** (1034751) 1 in.  
**BSN09967** (1034776) 1-1/2 in.  
**BSN09968** (1034784) 2 in.  
**BSN09969** (1034800) 3 in.

**E Presentation Ring Binder**

Thick polypropylene. Round rings. Customizable clear cover and spine. Interior pocket. 10% post-consumer waste.

- VLB 64803** (777235) 5/8 in.  
**VLB 64823** (777243) 1 in.  
**VLB 64833** (777250) 1-1/2 in.  
**VLB 64843** (777268) 2 in.

**F Customizable Poly Cover Binder**

Frosted front cover made of durable and flexible polypropylene. 1 in. round rings. Fully customizable. Print won't stick. Letter size. Assorted colours.

- WLJ 71772** (280677)



**F wilson jones**

**D Flexi-View Presentation Binder**

Preprinted colourful frame accents your title page. Durable, non-stick polypropylene material won't lift print. 1/2 in. with round rings hold 100 pages securely. Letter size.

- AVE 15767** (738526) black  
**AVE15766** (597237) blue

## A QuickFit® Presentation Binder

Polypropylene. PVC-free. D rings. Letter size. Seamless clear pocket on front and spine. 2 clear pockets. No ink transfer. 4 in. and 5 in. sizes have locking rings. 40% post-consumer waste.

### White

- RG0 87A000 (738427) 5/8 in.
- RG0870100 (208884) 1 in.
- RG0 870200 (208934) 1-1/2 in.
- RG0 870300 (208983) 2 in.
- RG0 870500 (209031) 3 in.
- RG0 870600 (716878) 4 in.
- RG0 870700 (280941) 5 in.

### Black

- RG0 87A001 (738435) 5/8 in.
- RG0870101 (208892) 1 in.
- RG0 870201 (208942) 1-1/2 in.
- RG0870301 (208991) 2 in.
- RG0 870501 (209049) 3 in.
- RG0870601 (233999) 4 in.
- RG0870701 (538819) 5 in.



**A** QuickFit



## B FreeStand™ Easy Open™ ClearVue™ Presentation Binder

Rigid poly cover. D rings. Magnetic flap closure. Set of 5 colour-coded ring-hole. Hole in spine for easy shelf removal. One-Touch EasyOpen rings, Clearview cover on front, back and spine. White.

- CRD 43120 (236547) 2 in.
- CRD 43130 (236554) 3 in.
- CRD 43140 (236612) 4 in.
- CRD 43150 (236638) 5 in.



**B** Cardinal



## C Offix® Presentation Binder

D-ring binders. PVC free polypropylene. Clear overlay on front and back covers and spine. Will not transfer ink from printed material. 2 interior pockets. Solid board is made of 100% recycled content.

### White

- NVX 346130 (346130) 1/2 in.
- NVX 346155 (346155) 1 in.
- NVX346197 (346197) 1-1/2 in.
- NVX 346239 (346239) 2 in.
- NVX 346270 (346270) 3 in.

### Black

- NVX 346148 (346148) 1/2 in.
- NVX 346163 (346163) 1 in.
- NVX 346205 (346205) 1-1/2 in.
- NVX 346247 (346247) 2 in.
- NVX 346288 (346288) 3 in.

### Blue

- NVX 346171 (346171) 1 in.
- NVX 346213 (346213) 1-1/2 in.
- NVX 346254 (346254) 2 in.
- NVX 346296 (346296) 3 in.

### Red

- NVX 346189 (346189) 1 in.
- NVX 346221 (346221) 1-1/2 in.
- NVX 346262 (346262) 2 in.
- NVX 346304 (346304) 3 in.



**C** offix



## D Slant Ring View Binder

D-rings. Made with PVC-free transfer-safe polypropylene. Clear non-stick clear overlay. 2 interior pockets.

### White

- BSN 28440 (1035071) 1 in.
- BSN 28441 (1035097) 1-1/2 in.
- BSN 28442 (1035113) 2 in.
- BSN 28443 (1034610) 3 in.
- BSN 28444 (1035056) 4 in.
- BSN28445 (1034578) 5 in.

### Black

- BSN 28446 (1035063) 1 in.
- BSN 28447 (1035089) 1-1/2 in.
- BSN 28448 (1035105) 2 in.
- BSN 28449 (1035121) 3 in.
- BSN 28450 (1035139) 4 in.
- BSN 28451 (1035147) 5 in.

### Blue

- BSN28452 (1034826) 1 in.
- BSN28453 (1034834) 1-1/2 in.
- BSN28454 (1034842) 2 in.



**D** BUSINESS SOURCE

- BSN28455 (1034850) 3 in.
- BSN28456 (1034867) 4 in.
- BSN28457 (1034875) 5 in.



**A** QuickFit



**B** AVERY

**A Deluxe Heavy-Duty Jr. Presentation Binder**

8-1/2 x 5-1/2 in. Polypropylene. PVC. Round rings. Overlay design allows for one-piece insert for cover and spine. 2 clear interior pockets. White.  
**RG085000** (530865) 5/8 in.  
**RG0 85110** (141093) 1 in.  
**RG0 85120** (141119) 1-1/2 in.  
**RG0 85130** (141184) 2 in.

**B Durable View Small Format Binder**

8-1/2 x 5-1/2 in. 3 round rings. Clear pockets on the front and spine. Interior pocket. Compatible with 7-hole punched accessories. 1 in. capacity.  
**AVE 17167** (190249) black  
**AVE 17116** (190256) white

**C Small Size Binder**

Polypropylene. PVC free. Round rings. Double triggers. Label holder on spine. Inside pocket. Black.  
**8-1/2 x 5-1/2 in.**  
**RG0 932101** (561878) 1 in.  
**RG0 932301** (404095) 2 in.  
**9-1/2 x 6 in.**  
**RG0 933101** (523449) 1 in.

**D Small Size Binder**

8-1/2 x 5-1/2 in. PVC free. Round rings. Double triggers. 2 inside pockets. Black.  
**BSN 28523** (1035493)



**C** DAVIS GROUP



**D** BUSINESS SOURCE

**E Deluxe Legal Size Presentation Binder**

14 x 8-1/2 in. Polypropylene. PVC free. Open spine ink transfer resistant clear overlay on front. 3 back mounted rings allow pages to lie flat. Two 4 in. interior clear pockets. Black. 100% recycled content, 85+% post-consumer waste.  
**RG0 95011P** (800607) 1 in.  
**RG0 95021P** (786863) 1-1/2 in.  
**RG0 95031P** (141259) 2 in.

**F Deluxe Legal Size Presentation Binder**

8-1/2 x 14 in. Polypropylene. PVC free. Open spine ink transfer resistant clear overlay on front. 3 back mounted rings allow pages to lie flat. Two 4 in. interior clear pockets. 100% recycled content, 85+% post-consumer waste.  
**White**  
**RG095020L** (234070) 1-1/2 in.  
**RG0 95030L** (1035287) 2 in.  
**Black**  
**RG0 95011L** (234062) 1 in.  
**RG095021L** (786855) 1-1/2 in.  
**RG095031L** (141267) 2 in.



**E** QuickFit



**F** QuickFit



**G Legal Size Binder**

Polypropylene. PVC free. Label holder on spine. Inside pocket. Black.  
**8-1/2 x 14 in. - 3 D-rings**  
**RG0934501** (404160) 1 in.  
**RG0934401** (404178) 2 in.  
**14 x 8-1/2 in. - 4 round rings**  
**RG0 934101** (404137) 1 in.  
**RG0934201** (404145) 1-1/2 in.  
**RG0 934301** (404152) 2 in.



**G** DAVIS GROUP



## A Deluxe Ledger Size Presentation Binder

11 x 17 in. Polypropylene. PVC free. D rings. Open spine for easy artwork insertion. Spine and inside front cover pockets. Back mounted rings allow pages to lie flat. No ink transfer. Double triggers. Locking ring mechanism. 100% recycled content, 85+% post-consumer waste.

### White

- RG094010 (234088) 1 in.
- RG094020 (786475) 1-1/2 in.
- RG094030 (141200) 2 in.
- RG094050 (141242) 3 in.

### Black

- RG0 94011 (1036466) 1 in.
- RG0 94021 (1036474) 1-1/2 in.
- RG0 94031 (1036482) 2 in.
- RG0 94051 (1035402) 3 in.



**A** QuickFit

## B ClearVue Ledger Size Presentation Binder

11 x 17 in. Slant-D rings. Clear overlay for customization on all three sides. White. 63% recycled content, 59% post-consumer waste.

- CRD 22112 (1036459) 1 in.
- CRD22122 (236901) 1-1/2 in.
- CRD 22132 (236919) 2 in.
- CRD 22142 (236927) 3 in.



**B** Cardinal

## C Xtralife Ledger Size Ring Binder

11 x 17 in. Slant D-rings. 2 interior pockets. Black.

- CRD 32112 (1036342) 1 in.
- CRD 32122 (1036350) 1-1/2 in.
- CRD 32132 (528018) 2 in.
- CRD 32142 (534826) 3 in.



**B** Cardinal

## D 9400 Series Ledger Ring Binder

11 x 17 in. D rings. Clear label holder on spine. One interior front cover pocket to secure loose documents and allow for easy identification of content. Constructed in heavy gauge grained antimicrobial material. Back mounted heavy duty locking Angle D rings allow pages to lie flat. Black.

- RG0 94111 (523456) 1 in.
- RG0 94121 (552133) 1-1/2 in.
- RG0 94131 (523464) 2 in.



**C** Cardinal

## E Duraply Poly Ring Binder

11 x 17 in. Ledger size. D rings. Made of 3 layers of polypropylene to withstand commercial requirements, including a polypropylene foam middle layer. Spine pocket. PVC free and solvent-resistant. Black.

- VLB 69820 (549857) 1 in.
- VLB69830 (1036391) 1-1/2 in.
- VLB 69840 (558627) 2 in.



**D** DAVIS GROUP



## F Cheque Binder

Clear interior front cover pocket to secure loose documents. Sewn edges. Nickel 1/2 in. rings and corners. Black.

- 1 cheque per page - 4 x 12 in.  
RG0 1UP01 (513903)
- 2 cheques per page - 7 x 12 in.  
RG0 2UP01 (247445)



**F** DAVIS GROUP



**E** vlb



**A** **Cardinal®**



**B** **Cardinal®**

**A Binder Pocket**

Polypropylene. Zippered. 3-hole punched. 1/2 in. expansion. Holds up to 100 letter size sheets. Assorted colours. Package of 5. **CRD 14650** (271379)

**B Binder Pocket**

Polypropylene. Zippered. 3-hole punched. 1/2 in expansion. Holds up to 100 letter size sheets. Clear. Package of 3. **CRD 14201** (1038199)

**C Binder Pocket**

Plastic. Zippered. 7-hole punched, allows use in various size binders. Clear. **BSN 01606** (1039171) 9 -1/2 x 6 in. **BSN 01607** (1038165) 10 x 8 in.



**C** **BUSINESS SOURCE®**



**D** **GEO**

**D Binder Pocket with Flap**

Polypropylene. Snap button closure. 3 sections. 3-hole punched. Snap button closure. Assorted colours. **GCI 6009** (158881)

**E Binder Pocket with Flap**

Polypropylene. Velcro closure. 4 sliding pockets. 3-hole punched. Fold-out strip can be tucked out of the way when used out of the binder. Blue. **OXF 35103** (192583)

**F Binder Pocket with Flap**

Polypropylene. Velcro closure. 3-hole punched. Holds up to 100 letter size sheets. Translucent frosted finish. **OXF 98733C** (528224)



**E** **Oxford™**



**F** **Oxford™**

**G Binder Pocket with Flap**

Polypropylene. Velcro closure. 3-hole punched. Reusable with velcro closure. Holds 20 letter size sheets. Clear. **WNNBP12-CR** (739060)

**H Wave Curved Binder Pocket**

Polypropylene. Tear and water resistant. 3-hole punched. Letter size. Package of 5. Assorted colours. **PFX 31820C** (1027390)

**I Slant Curved Binder Pocket**

Polypropylene. Durable heavy gauge static free. 3-hole punched. 50-sheet capacity. Letter size. Package of 5. **Clear** **WNNSP-02-CR** (234385) no tabs **Assorted colours** **WNN SP-01AD** (786665) no tabs **WNN TP-55AD** (567495) 5 tabs **WNN TP-88AD** (549931) 8 tabs



**G** **Winnable**



**H** **Pendaflex®**

**J Poly Binder Pocket**

Polypropylene. 20-sheet capacity. PVC-free. Letter size. Clear. Package of 5. **BSN 32375** (1036524)



**I** **Winnable**



**J** **BUSINESS SOURCE®**



## A Slant Binder Pocket

Cardstock, 3-hole punched. Letter size. Package of 25. Assorted colours.  
**PFX32940** (271759)



**A** **Pendaflex®**



**B** **Pendaflex®**



## B Wave Pocket Binder Pocket

11pt. 3-hole punched. Letter size. Assorted colours. Package of 10.  
**PFX 32900** (646356)



## C HOLD IT® Label Holders

For binders, file drawers or report covers. Self-adhesive high quality clear poly. Will not damage contents.

**CRD 21810** (421586) 1 x 3 in. (pkg 12)  
**CRD 21820** (421925) 1-3/8 x 3 in. (pkg 12)  
**CRD21830** (421933) 2-3/16 x 2 in. (pkg 6)

## D Binder Label Holder

Ideal for binder or store and warehouse shelf ticket. Soft vinyl. Self-adhesive clear back. Inserts included. Shorter front section. Package of 10.

**GMX CW-646** (759936) 1-1/8 x 3-1/2 in.  
**GMX CW-647** (759902) 1-1/2 x 5-1/2 in.  
**GMX CW-648** (759928) 2 x 3-1/2 in.



**C** **TOPS PRODUCTS**

**D** **GEMEX**



## E Self-Adhesive Reinforcements

Round, tear-resistant. Permanent adhesive. 1/4 in. diameter.  
**AVE 2350** (594762) white (pkg 225)  
**AVE 2352** (594770) clear (pkg 250)

## F Self-Adhesive Reinforcements

1/4 in. diameter hole. 40 reinforcements per sheet.  
 Package of 200. White.  
**AVE 2360** (804765)



**E** **AVERY**

**F** **AVERY**

## G Self-Adhesive Poly Pockets

Crystal-clear, durable PVC-free poly with permanent adhesive. Box of 100.

**SMD 68123** (427419) 4 x 3 in.  
**SMD 68153** (427435) 5 x 3 in.  
**SMD 68164** (365197) 6 x 4 in.  
**SMD 68185** (427450) 8 x 5 in.

## H Self-Adhesive Business Card Pockets

Ideal to identify binders, catalogues or folders. 3-3/4 x 2-1/2 in. Package of 12.  
**GMXCW-650** (757708)



## I Magazine Holder

Clear plastic. For 3-ring binder. Package of 12.  
**RUB T02802** (484667)

## J Literature Page Holder

Clear resistant vinyl with reinforced margin. To insert and protect magazines, small catalogues, brochures. Use in 3-ring binders. Letter size.

**GMX MAG119-5** (797092)



**G** **SMEAD®**



**H** **GEMEX**



Find CD/DVD and USB Binder Pockets on **page 47**



**I** **Rubbermaid**



**J** **GEMEX**





**A** **AVERY**

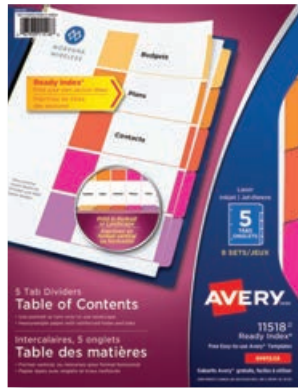

**B** **AVERY**



**A Ready Index® Dividers**

For ink jet, laser printers, copiers and typewriters. Pre-printed tabs. Assorted colours. 20% post-consumer waste.

- 1 set**  
**AVE11131** (305185) 1-5  
**AVE11133** (305193) 1-8  
**AVE11135** (305201) 1-10  
**AVE 11141** (396200) 1-12  
**AVE 11143** (396127) 1-15  
**AVE 11129** (396093) 1-31  
**AVE 11125** (396101) A-Z  
**AVE11127** (396077) JAN-DEC  
**6 sets**  
**AVE 11187** (521849) 1-5  
**AVE 11189** (521856) 1-8  
**AVE 11188** (420562) 1-10  
**AVE 11196** (358440) 1-12  
**AVE 11197** (358457) 1-15

**B Ready Index® Dividers**

For ink jet, laser printers, copiers and typewriters. Un-printed tabs. Package of 6. Assorted colours. 20% post-consumer waste.

- AVE 11518** (628941) 5 tabs  
**AVE 11519** (628958) 8 tabs  
**AVE11520** (628966) 10 tabs

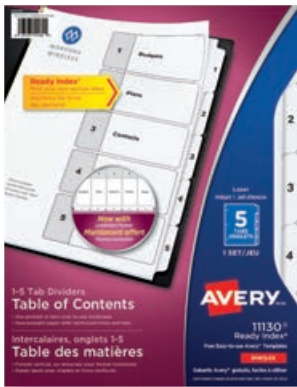

**C** **AVERY**

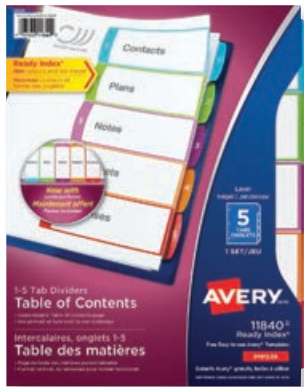

**D** **AVERY**



**C Ready Index® Dividers**

For ink jet, laser printers, copiers and typewriters. Pre-printed tabs. Black and white. 20% post-consumer waste.

- AVE 11130** (396168) 1-5  
**AVE 11132** (396176) 1-8  
**AVE 11134** (396184) 1-10  
**AVE 11140** (396192) 1-12  
**AVE 11142** (396119) 1-15

**D Ready Index® Dividers**

For ink jet, laser printers, copiers and typewriters. Pre-printed curved tabs. Assorted colours. 20% post-consumer waste.

- AVE 11840** (560870) 1-5  
**AVE 11841** (535104) 1-8  
**AVE 11842** (521872) 1-10  
**AVE 11843** (546903) 1-12  
**AVE 11845** (535120) 1-15  
**AVE 11846** (521880) 1-31  
**AVE 11844** (535112) A-Z  
**AVE 11847** (535138) JAN-DEC

**E Super Rapidex™ Pre-Printed Dividers**

Premium white stock. 3-hole punched. Plastic reinforced tabs and reinforced binding edge. Assorted colour tab matching the table of contents. 10% post-consumer fibre.

- OXFCR2135NSRD** (281022) 1-5  
**OXFCR2138NSRD** (235382) 1-8  
**OXFCR21310NSR** (235424) 1-10  
**OXFCR21312NSR** (280974) 1-12  
**OXFCR21315NSR** (235432) 1-15  
**OXFCR21331NSR** (281014) 1-31  
**OXFCR213SRD** (281030) A-Z  
**OXF280958** (280958) JAN-DEC



**E** **Oxford™**



**F** **offix**



**F Offix® Colour-Coded Index Dividers**

For laser and inkjet printers. Includes table of contents sheet. 10% post-consumer material.

- NVX 349316** (349316) 1-5  
**NVX 349324** (349324) 1-8  
**NVX 349332** (349332) 1-10  
**NVX 349340** (349340) 1-15  
**NVX 349357** (349357) 1-31  
**NVX OFCR213SRD** (349365) A-Z  
**NVX349373** (349373) JAN-DEC

## A Ready Index® Double Column Dividers

Heavy weight paper. Reinforced holes and tabs. 2 columns table of contents. Double-layer tabs set to allow easier view and are easier to grab and turn. Letter size. Assorted colours. 20% post-consumer waste.  
**AVE 11320** (787796) 1-16  
**AVE 11321** (787804) 1-24  
**AVE 11322** (787812) 1-32



## B OneStep® Dividers

Reinforced tabs and holes. Inkjet and laser printer compatible. Pre-printed tabs, 1 to 52. Assorted colours.  
**CRD 60990** (535096)

## C Ready Index® Easy Edit Dividers

For ink jet and laser printers. Clear table of contents sleeve. Edit the table of contents anytime. Simply print on a plain sheet of 8-1/2 x 11" paper and slide it into the Table of Contents sleeve. Assorted colours. 20% post-consumer waste.  
**AVE 11172** (641274) 1-8  
**AVE 11173** (641282) 1-10



## D Print & Apply Dividers

For ink jet and laser printers. Includes dividers and sheet of transparent labels. 8 rounded tabs. 5 sets. Assorted colours. 20% post-consumer waste.  
**AVE 11419** (628917)



## E Print & Apply Dividers

For ink jet and laser printers. Includes dividers and sheet of transparent labels. Rounded tabs. White. 20% post-consumer waste.  
**1 set**  
**AVE 11416** (396259) 5 tabs  
**AVE 11417** (396234) 8 tabs  
**5 sets**  
**AVE 11436** (286260) 5 tabs  
**AVE 11437** (440719) 8 tabs  
**25 sets**  
**AVE 11446** (600031) 5 tabs  
**AVE 11447** (600049) 8 tabs

## F Printable Tab Dividers

For laser and inkjet printer. Includes table of content page. English. Letter size. White.  
**BSN 05852** (1037605) 1-5  
**BSN 05853** (1037613) 1-8  
**BSN 05854** (1037571) 1-10  
**BSN 05855** (1037589) 1-12  
**BSN 05857** (1037597) 1-15  
**BSN 05859** (1037563) 1-31  
**BSN 05858** (1037621) A-Z  
**BSN 05856** (1037639) JAN-DEC



## G Printable Divider

For laser printer. Customizable clear tab labels. Unpunched. Letter size. 25 sets. White. Contains 30% post-consumer materials.  
**(1037969)** 5 tabs  
**BSN16488** (1037977) 8 tabs

## H Print-On Tab Dividers

Economical. High quality dividers for high speed copiers. 90 brightness paper. White tabs. 5 tabs per set. Package of 50 sets.  
**Xerox 5090 double reverse collated**  
**BSN 02077** (1037647) 3-hole punched  
**Xerox Docutech /4135 single reverse collated**  
**BSN 21000** (1038033) unpunched





**A** **AVERY**



**B** **AVERY**

**A Big Tabs™ Write-On Dividers**

Write, erase and reuse. 50% bigger tabs for more printing space. Made with 30% post-consumer waste.  
**AVE 23075** (428474) 5 tabs  
**AVE 23078** (428482) 8 tabs

**B Write-On Tab Divider**

Write directly on the non laminated tabs. Clear plastic reinforced holes. Letter size. 5 tabs. 3 sets. Assorted colours.  
**AVE 11508** (1037670)

**C Earthwise® Dividers**

Tabs and binding edge are reinforced with a clear rip-proof plastic. Manila. Letter size. Acid-free. 100% recycled content, 50% post-consumer fibre. FSC® certified.  
**OXF10087** (226167) 5 tabs



**C** **Earthwise**  
OXFORD



**D** **Oxford™**



**D Subject Dividers**

9-pt heavy-duty Bristol cardboard. 5 blank tabs. 3-hole punched. Assorted colours. 10% post-consumer fibre.  
**OXF 213-B** (225151)

**E Write-On Index Dividers**

7-pt stock. Matte finish allowing writing without any smudging. White. Reinforced binding edge. 3-hole punched. Letter size. 1 set.  
**OXF WR213-5W** (281089) 5 tabs  
**OXFWR213-8W** (676247) 8 tabs



**E** **Oxford™**



**F** **Oxford™**

**F Dividers With Schedule**

5 tabs. Letter size.  
**OXF 213-S** (290114)

**G Plain Tab Dividers**

Non-reinforced index stock. Letter size. 10% post-consumer fibre.  
**White**  
**OXF 213-5W/1** (474189) 5 tabs  
**OXF 213-8W/1** (615781) 8 tabs  
**Buff**  
**OXF 213-5B/1** (1038009) 5 tabs

**H Laminated Tab Dividers**

Place label or write directly on tabs. Laminated tabs. Letter size. Assorted colours. 100% recycled content, 50% post-consumer.  
**BSN 20074** (1037878) 5 tabs  
**BSN 20075** (1037894) 8 tabs



**G** **Oxford™**



**H** **B** BUSINESS SOURCE®



**I** **B** BUSINESS SOURCE®

**I Reinforced Plain Tab Divider**

Heavy-duty paper reinforced and three holes punched. Place label on or write directly on tabs. Non laminated. White. Letter size.  
**1 set**  
**BSN 20072** (1037985) 5 tabs  
**BSN 20073** (1037993) 8 tabs  
**24 sets**  
**BSN 36683** (1037845) 5 tabs  
**BSN 36684** (817924) 8 tabs  
**100 sets**  
**BSN 20070** (1037860) 5 tabs  
**BSN 20071** (1037886) 8 tabs

## A Extra Wide Tab Dividers

Translucent plastic tabs with inserts. 3-hole punched with binding edge reinforcement. Extra wide to show past sheet protectors. 11 x 9-1/4". Buff. 10% recycled content; 10% post-consumer waste.

### Assorted colours

**OXF R215-5A** (191833) 5 tabs

**OXF R215-8A** (191858) 8 tabs

### Clear

**OXF R215-5C** (191841) 5 tabs

**OXF R215-8C** (191866) 8 tabs



**A** **Oxford™**



**B** **Oxford™**



## B Insertable Tab Dividers

Translucent plastic tabs with inserts. Plastic reinforced 3-hole punched binding edge. Letter size. Buff. 10% post-consumer fibre.

### Assorted colours

**OXFR213-5A** (224857) 5 tabs

**OXFR213-8A** (224873) 8 tabs

### Clear

**OXF R213-5C** (224865) 5 tabs

**OXFR213-8C** (224881) 8 tabs



**C** **Oxford™**



**D** **offix.**



## C Self-Adhesive Tabs

1-1/2" wide. Pre-cut tabs, with inserts. Package of 10.

**OXF 15A** (225128) assorted colours

**OXF 15C** (3723) clear

## D Offix® White Index Dividers

8-1/2 x 11". 3-hole punch. Includes 2 printable label sheets. Works with most work processing software. 10% post-consumer material.

### 5 sets

**ESS CRD-5** (349274) 5 tabs

**NVX OF-CRD-8** (349282) 8 tabs

### 25 sets

**NVX OF-CRD-5B** (349290) 5 tabs

**NVX OF-CRD-8B** (349308) 8 tabs



**E** **AVERY**

**F** **B BUSINESS SOURCE®**

## E Big Tab Storage Dividers

Printable inserts are 50% bigger. Print both sides of the insert at the same time. Gold reinforced edge. 8-1/2 x 11 in.

### Clear

**AVE 1122** (674697) 5 tabs

**AVE 1124** (674713) 8 tabs

### Assorted colours

**AVE 1122** (1037928) 8 tabs



## F Insertable Tab Divider

Translucent plastic tear-resistant tabs. Plastic reinforced binding edge. White inserts included. Letter size. Buff.

### Assorted colours

**BSN 36692** (1037795) 5 tabs

**BSN 36693** (1037803) 8 tabs

### Clear

**BSN 20068** (1037811) 5 tabs

**BSN 20069** (1037829) 8 tabs

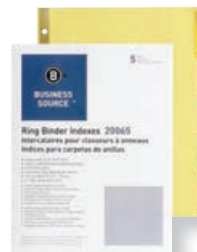

## G Wide Tab Divider

For laser and inkjet printer. Heavy-duty stock. Gold mylar strip with 3-hole punched. Includes blank white tabs. Letter size. Buff.

### Assorted colours

**BSN20065** (1037746) 5 tabs

**BSN 20067** (1037754) 8 tabs

### Clear

**BSN 20066** (1037761) 5 tabs

**BSN 36691** (1037779) 8 tabs

**G** **B BUSINESS SOURCE®**

## H Wide Tab Divider

Translucent plastic tear-resistant tabs. Gold mylar reinforced binding edge. Includes blank white tabs that are laser and inkjet printer compatible. Letter size. White.

**BSN 16477** (1037902) 5 tabs

**BSN 16479** (1037910) 8 tabs



**H** **B BUSINESS SOURCE®**

## I Tab Divider With Pocket

7 pt carton. 4 in. deep pocket with a diagonal shape. Rip-proof tabs. Letter size. 5 tabs. Assorted colours.

**BSN 02073** (1038059)



**I** **B BUSINESS SOURCE®**



**A** **Earthwise**  
OXFORD



**B** **Oxford**



**A Earthwise® Dividers**

Tabs and binding edge are reinforced with a clear rip-proof plastic. Manila. Letter size. Acid-free. 100% recycled content, 50% post-consumer fibre. FSC® certified.

- OXF 10078** (141739) 1-31
- OXF 10080** (141754) A-Z
- OXF 10079** (141747) JAN-DEC

**B Printed Dividers**

Plastic reinforced tabs. Reinforced binding edge. Buff. 10% post-consumer fibre.

- OXF CR213-10B** (224477) 1-10
- OXF CR213-25** (335372) 1-25
- OXFCR213-31** (224444) 1-31
- OXF CR213-50N** (224493) 1-50
- OXF CR213-100N** (3640) 1-100
- OXF CR213** (224428) A-Z
- OXF CR213-12** (224436) JAN-DEC



**C** **Oxford**



**D** **offix**



**C Pre-Printed Dividers**

Premium white stock. Plastic reinforced tabs and reinforced binding edge. 10% post-consumer fibre.

- OXF CR213-10W** (326249) 1-10
- OXF RCR21331** (232579) 1-31
- OXF CR213-50W** (698282) 1-50
- OXF CR213-100W** (698290) 1-100
- OXF RCR213** (232546) A-Z
- OXF RCR21312** (232561) JAN-DEC

**D Offix® Buff Index Dividers**

For laser and inkjet printers. Buff. 10% post-consumer recycled content.

- NVX OF-CR21331** (349407) 1-31
- NVX OF-CR213** (349381) A-Z
- NVX OF-CR21312** (349399) JAN-DEC



**E** **Oxford**



**F** **wilson jones**

**E Poly Pre-Printed Dividers**

Polypropylene. 3-hole punched. Titles printed on both sides in large, bold type. Non-stick and acid-free. White.

- OXF PL213-31W** (757674) 1-31
- OXF PL213W** (757666) A-Z
- OXF PL213-12W** (757682) JAN-DEC

**F View-Tab® Extra-Wide Dividers**

Sturdy transparent polypropylene. Titles are always in view, through the tabs. 8 tabs. Assorted colours.

- WLJ 55070** (736363)



**G** **AVERY**



**H** **Oxford**

**G Big Tab™ Write & Erase Plastic Dividers**

Durable plastic. Write, erase and re-use. Letter size. PVC free. Assorted colours.

- AVE 16170** (787598) 5 tabs
- AVE 16171** (787606) 8 tabs

**H Poly Plain Tab Dividers**

Opaque polypropylene. Blank tabs with self-adhesive labels. 3-hole punched. Acid-free. Assorted colours.

- OXF PL213-5RBW** (714626) 5 tabs
- OXF PL213-8RBW** (714634) 8 tabs
- OXF PL21310RBW** (714642) 10 tabs

Pocket holds up to 100 sheets



**I** **Cardinal**



**J** **Oxford**

**I Expanding Pocket Divider**

Extra-tough poly. Large insertable tabs. 100-sheet capacity. Letter size. Assorted colours.

- CRD 84012CB** (1037655) 5 tabs
- CRD 84013** (1037662) 8 tabs

**J Rapidex™ Poly Dividers**

Polypropylene. For ink jet and laser printers. Multi-colored with table of contents sheet. Tear-resistant. 3-hole punched. Letter size. 1 set.

- OXF PL213-5RD** (281063) 5 tabs
- OXF PL213-8RD** (281071) 8 tabs

## A Big Tab™ Insertable Plastic Dividers

Durable, flexible plastic that is PVC-free. Featuring larger tabs that offer 1.5x times more printing space. 3-hole punched. 9-1/4 x 11-1/8 in. Assorted translucent colours.

### Without pocket

**AVE 11900** (597229) 5 tabs

**AVE 11901** (597211) 8 tabs

### With pocket

**AVE 11902** (597203) 5 tabs

**AVE11903** (551366) 8 tabs



## B Dividers

Polypropylene. Inside pocket. Pastels colours.

**GCI IP115A** (226340) 5 tabs

**GCI IP118A** (226357) 8 tabs



## C Style Edge™ Dividers

Durable polypropylene. Insertable tabs. PVC free. Assorted colours.

**AVE 11200** (714451) 5 tabs

**AVE 11201** (714469) 8 tabs

## D Big Tab™ Ultralast™ Plastic Dividers

Durable plastic. Write-on tabs. PVC-free. Assorted colours.

**AVE 24900** (352120) 5 tabs

**AVE 24901** (352138) 8 tabs



## E Clear Easy View Durable Plastic Dividers

Create or update section titles on one sheet, and insert into included sheet protector; tab titles are visible through clear dividers. Extra durable tear-resistant plastic. Assorted colours.

**AVE 16740** (551309) 5 tabs

**AVE16741** (560896) 8 tabs



## F Poly Insertable Tab Dividers

Translucent non-stick polypropylene tabs with inserts. 3-hole punched. Assorted colours.

### Without pocket

**OXF 31451** (649442) 5 tabs

**OXF PF31481** (665331) 8 tabs

### With pocket

**OXF 31651** (714659) 5 tabs

**OXF 31681** (714667) 8 tabs



## G Poly Tab Index Divider

Letter size. Fits standard 3-ring binders. Assorted colours.

**WNNWID-50AD** (559120) 5 tabs

**WNNWID-80AD** (549964) 8 tabs



## H Poly Pocket Divider

Polypropylene. 8 tabs. Blank inserts included. Letter size. Assorted colours.

**BSN 32371** (1037952) no pocket

**BSN32372** (1037944) 1 pocket

**BSN 32373** (1037936) 2 pockets



## I Poly Dividers

Durable poly. Non-insertable tabs. Assorted colours. Letter size.

**BSN 01809** (1038017) 5 tabs

**BSN 01810** (1038025) 8 tabs





**A** **AVERY**

For small binders  
8-1/2 x 5-1/2 in.

**B** **Oxford**



**A Poly Dividers for Small Size Binder**  
5-1/2 x 8-1/2 in. 7-hole punched. Write-on tabs. 5 tabs. Assorted colours. 20% post-consumer recycled material.  
**AVE 16180** (164699)



**B Legal Size Dividers**  
14 x 8-1/2 in. 4-hole punched. Pre-printed reinforced tabs. Reinforced binding edge. Buff. 10% post-consumer fibre.  
**OXF CR217-31** (224469) 1-31  
**OXF CR217** (224451) A-Z

**C Insertable Tab Dividers**  
14 x 8-1/2 in. 4-hole punched. Insertable tabs. Reinforced binding edge. Buff. 10% post-consumer fibre.  
**Clear**  
**OXFR217-5C** (224923) 5 tabs  
**OXF R217-8C** (224949) 8 tabs  
**Assorted colours**  
**OXFR217-5A** (224915) 5 tabs  
**OXFR217-8A** (224931) 8 tabs



**C** **Oxford**



**D Ledger Size Poly Dividers**  
11 x 17 in. Polypropylene. Acid-free. Scratch-resistant. Transfer-safe. Adhesive labels included. Assorted colours.  
**CRD 84250** (166462) 5 tabs  
**CRD 84803** (244335) 8 tabs

**E Write 'n Erase® Ledger Size Dividers**  
Mylar tabs allow use of any pen, pencil or non-permanent markers. White.  
**CRD84270** (166488) 5 tabs  
**CRD 84271** (566224) 8 tab

**F Ledger Size Poly Dividers**  
Polypropylene. Acid-free. Scratch-resistant. Transfer-safe. Adhesive labels included. Assorted colours. 8 tabs.  
**CRD 84251** (166470)



**D** **Cardinal**

**E** **Cardinal**

**G Ledger Size Dividers**  
17 x 11 in. Paper. Insertable tabs. 8 tabs. White.  
**CRD 84815** (534834)

**H Ledger Size Poly Dividers**  
11 x 17 in. 5 tabs. Assorted colours.  
**VLB 30218** (558635)

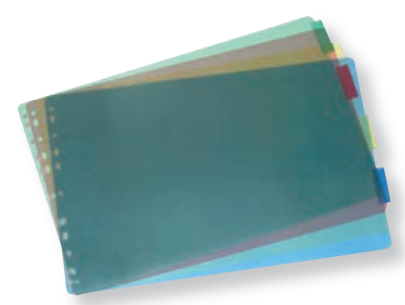

**F** **Cardinal**

**G** **Cardinal**

**H** **vlb**



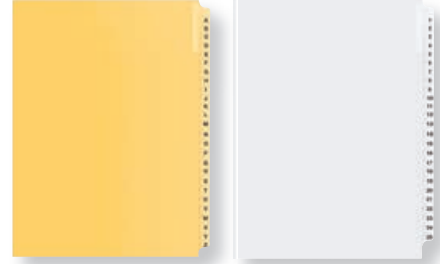

BUFF LITIGATION INDEX TABS - NUMERICAL - 1/25TH CUT. 11 X 8-1/2 IN.				
NUMBER	QTY/ PKG	CODE	REFERENCE	PRICE
#1	25	DAV B14001	539486	
#2	25	DAV B14002	539619	
#3	25	DAV B14003	539726	
#4	25	DAV B14004	539825	
#5	25	DAV B14005	539932	
#6	25	DAV B14006	540047	
#7	25	DAV B14007	540146	
#8	25	DAV B14008	540252	
#9	25	DAV B14009	540369	
#10	25	DAV B14010	539494	
#11	25	DAV B14011	539510	
#12	25	DAV B14012	539528	
#13	25	DAV B14013	539544	
#14	25	DAV B14014	539551	
#15	25	DAV B14015	539569	
#16	25	DAV B14016	539577	
#17	25	DAV B14017	539585	
#18	25	DAV B14018	539593	
#19	25	DAV B14019	539601	
#20	25	DAV B14020	539627	
#21	25	DAV B14021	539635	
#22	25	DAV B14022	539643	
#23	25	DAV B14023	539650	
#24	25	DAV B14024	539668	
#25	25	DAV B14025	539676	
#26	25	DAV B14026	539684	
#27	25	DAV B14027	539692	
#28	25	DAV B14028	539700	
#29	25	DAV B14029	539718	
#30	25	DAV B14030	539734	
#31	25	DAV B14031	539742	
#32	25	DAV B14032	539759	
#33	25	DAV B14033	539767	
#34	25	DAV B14034	539775	
#35	25	DAV B14035	570044	
#36	25	DAV B14036	539783	
#37	25	DAV B14037	539791	
#38	25	DAV B14038	539809	
#39	25	DAV B14039	539817	
#40	25	DAV B14040	539833	
#41	25	DAV B14041	539841	
#42	25	DAV B14042	539858	
#43	25	DAV B14043	539866	
#44	25	DAV B14044	539874	
#45	25	DAV B14045	539882	
#46	25	DAV B14046	539890	
#47	25	DAV B14047	539908	
#48	25	DAV B14048	539916	
#49	25	DAV B14049	539924	
#50	25	DAV B14050	539940	

BUFF LITIGATION INDEX TABS - SEQUENTIAL AND INDEX - 14 X 8-1/2 IN.				
NUMBER	QTY/ PKG	CODE	REFERENCE	PRICE
1 À 25	1set	DAV B18500	540823	
26 À 50	1set	DAV B18501	543405	
51 À 75	1set	DAV B18502	540989	
76 À 100	1set	DAV B18503	543413	
INDEX	25	DAV B18602	540807	

BUFF LITIGATION INDEX TABS - ALPHABETICAL - 1/26TH CUT. 11 X 8-1/2 IN.				
LETTER	QTY/ PKG	CODE	REFERENCE	PRICE
A	25	DAV B15000	829292	
B	25	DAV B15001	829294	
C	25	DAV B15002	829295	
D	25	DAV B15003	829296	
E	25	DAV B15004	829297	
F	25	DAV B15005	829298	
G	25	DAV B15006	829299	
H	25	DAV B15007	829300	
I	25	DAV B15008	829301	
J	25	DAV B15009	829302	
K	25	DAV B15010	829303	
L	25	DAV B15011	829304	
M	25	DAV B15012	829305	
N	25	DAV B15013	829306	
O	25	DAV B15014	829307	
P	25	DAV B15015	829308	
Q	25	DAV B15016	829309	
R	25	DAV B15017	829310	
S	25	DAV B15018	829311	
T	25	DAV B15019	829312	
U	25	DAV B15020	829313	
V	25	DAV B15021	829314	
W	25	DAV B15022	829315	
X	25	DAV B15023	829316	
Y	25	DAV B15024	829320	
Z	25	DAV B15025	829321	

BUFF LITIGATION INDEX TABS - SEQUENTIAL - 11 X 8-1/2 IN.				
SEQUENCE	QTY/ PKG	CODE	REFERENCE	PRICE
A À Z	1set	DAV B17100	829293	
1 À 5	1set	DAV B17000	829289	
1 À 10	1set	DAV B17001	829290	
1 À 15	1set	DAV B17002	829291	
1 À 25	1set	DAV B12000	539478	
26 À 50	1set	DAV B12001	540476	
51 À 75	1set	DAV B12002	540526	
76 À 100	1set	DAV B12003	540534	
101 À 125	1set	DAV B12004	572107	
126 À 150	1set	DAV B12005	539445	
151 À 175	1set	DAV B12006	572115	
176 À 200	1set	DAV B12007	572131	
201 À 225	1set	DAV B12008	572149	
226 À 250	1set	DAV B12009	539460	

BUFF LITIGATION INDEX TABS - INFORMATIONAL - 11 X 8-1/2 IN.				
TEXT	QTY/ PKG	CODE	REFERENCE	PRICE
TABLE OF CONTENTS	25	DAV B17500	579045	
TABLE DES MATIÈRES	25	DAV B17501	575621	
ONGLET VIÈRGE	25	DAV B17302	575639	
INDEX	25	DAV B17400	575944	

WHITE LITIGATION INDEX TABS - NUMERICAL - 1/25TH CUT. 11 X 8-1/2 IN.				
NUMBER	QTY/ PKG	CODE	REFERENCE	PRICE
#1	25	DAV W04001	574673	
#2	25	DAV W04002	574681	
#3	25	DAV W04003	574699	
#4	25	DAV W04004	574707	
#5	25	DAV W04005	574715	
#6	25	DAV W04006	574723	
#7	25	DAV W04007	574731	
#8	25	DAV W04008	574749	
#9	25	DAV W04009	574756	
#10	25	DAV W04010	574764	
#11	25	DAV W04011	574772	
#12	25	DAV W04012	574780	
#13	25	DAV W04013	575662	
#14	25	DAV W04014	574798	
#15	25	DAV W04015	574806	
#16	25	DAV W04016	574814	
#17	25	DAV W04017	574822	
#18	25	DAV W04018	574830	
#19	25	DAV W04019	574848	
#20	25	DAV W04020	574855	
#21	25	DAV W04021	574863	
#22	25	DAV W04022	574871	
#23	25	DAV W04023	574889	
#24	25	DAV W04024	574897	
#25	25	DAV W04025	574905	

WHITE LITIGATION INDEX TABS - SEQUENTIAL - 11 X 8-1/2 IN.				
SEQUENCE	QTY/ PKG	CODE	REFERENCE	PRICE
A À XYZ	1set	DAV W07100	829322	
1 À 5	1set	DAV W07000	829317	
1 À 10	1set	DAV W07001	829319	
1 À 15	1set	DAV W07002	829318	
1 À 25	1set	DAV W02000	574947	
26 À 50	1set	DAV W02001	574954	
51 À 75	1set	DAV W02002	574962	
76 À 100	1set	DAV W02003	574970	
101 À 125	1set	DAV W02004	574988	
126 À 150	1set	DAV W02005	809921	
151 À 175	1set	DAV W02006	809913	
176 À 200	1set	DAV W02007	809905	

WHITE LITIGATION INDEX TABS - INFORMATIONAL - 11 X 8-1/2 IN.				
TEXT	QTY/ PKG	CODE	REFERENCE	PRICE
TABLE OF CONTENTS	25	DAV W07402	574913	



**A** GEMEX



**B** GEMEX



**A Non-Glare Page Holders**

Polypropylene. Non-stick and no ink transfer. Colours will not fade. Archival quality. Acid-free. Non-glare. Letter size.

**Standard weight**

GMX PP2119-10 (469577) pkg 10

GMX PP2119 (629287) box 100

**Heavyweight**

GMX PP3119-10 (416909) pkg 10

GMX PP3119 (629279) box 100

**Heavyweight - high capacity**

GMX PPXL311910 (714675) pkg 10

GMX PPXL3119 (714691) box 50

**Super heavyweight**

GMX PP4119-10 (757039) pkg 10



**C** GEMEX



**D** GEMEX



**B Ultra-Clear Page Holders**

Polypropylene. Non-stick and no ink transfer. Colours will not fade. Archival quality. Acid-free. Letter size.

**Standard**

GMX PPC2119-10 (774190) pkg 10

GMX PPC2119 (774182) box 100

**Heavyweight**

GMX PPC3119-10 (469585) pkg 10

GMX PPC3119 (629261) box 100

**C Antimicrobial Sheet Protectors**

Ultra-Clear. Polypropylene. Non-stick and no ink transfer. Colours will not fade. Archival quality. Acid-free. Letter size. Package of 100.

GMX PPCA3119 (833005)

**D Recycled Sheet Protectors**

Standard weight. 3-hole punched. Acid-free. Archival quality.

Letter size. Up to 60% recycled content.

GMX PPR2119-10 (171819) pkg 10

GMX PPR2119 (171801) box 100



**E** wilson jones

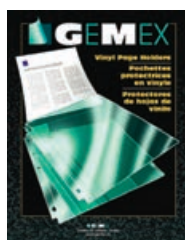

**F** GEMEX



**E Envi Recycled Sheet Protectors**

Clear polypropylene. Standard thickness. Non-stick and no ink transfer. Acid free archival quality. Acid-free. Top loading. Letter size. Box of 50. 80% recycled content.

WLJ 7891031927 (232413)

**F Vinyl Page Holders**

Soft clear vinyl. Thickness: 6 mil. Sealed on 3 sides. 3-hole punched. Box of 50.

GMX 119-3 (664888) letter

GMX 149-4 (664870) legal



**G** AVERY



**H** AVERY

**G Page Size Sheet Protectors**

Polypropylene. Page size for use with tab dividers. Documents must be perforated. Clear. Non-stick. Acid free archival quality. Package of 50. Letter size.

AVE 78630 (571075)

**H Side Insert Sheet Protectors**

The opening is located on the side of the rings. Polypropylene. Archive quality. Acid-free. 3-hole punched. Side opening. Letter size. Package of 25.

AVE 78629 (234401)



**I** AVERY



**J** wilson jones

**I Secure Top Sheet Protectors**

Perfect to store non-standard sized documents. Polypropylene. Archive quality. Acid-free. 3-hole punched. Top opening. 8-1/2 x 11". Package of 25.

AVE 78602 (234393)

**J Non-Glare Sheet Protectors**

Universal hole punching- 11 holes to fit any 3 ring binder. Archival quality. Letter size. Box of 100.

WLJ11781 (460519) standard

WLJ 11792 (545137) heavyweight

## A Rigid Vinyl Sheet Protectors

Oval perforations. 3-hole punched. Not recommended for archiving. Heavyweight. Letter size. Box of 50.

### Ultra-clear

**GMXV-427** (664862) no insert

### Non-glare

**GMX FV-427** (664912) no insert

**GMXV-4271** (664847) with black insert



## B Polypropylene Sheet Protectors

Archival-safe clear polypropylene "Gemlar". Non-stick and no ink transfer. Acid-free. Tear-proof. Lightweight. Letter size. Box of 50. **GMX G-6027** (664938)

## C Sheet Protectors

Polypropylene. 3-hole punched. Standard thickness. Letter size. Package of 12. Assorted colours.

**GCI 1332012** (106922)



## D Offix® Page Protectors

Non-glare polypropylene. Lightweight. Letter size.

**NVX345777** (345777) pkg 10

**NVX 345769** (345769) box 100



## E Clear Sheet Protectors

Polypropylene. 3-hole punched. Reinforced strip. No ink transfer. Letter size.

### Standard weight

**BSN 32357** (1038611) pkg 50

**BSN 74551** (1038496) box 100

### Heavyweight

**BSN 16512** (1038462) box 50

### Super heavyweight

**BSN16511** (1038470) box 50

**BSN 74550** (1038504) box 100

**BSN 74552** (1038546) box 200



## F Non-Glare Sheet Protectors

Polypropylene. 3-hole punched. Reinforced strip. No ink transfer. Letter size.

### Standard weight

**BSN 32356** (1038538) pkg 50

### Heavyweight

**BSN 16514** (1038488) box 50

**BSN 74449** (1038554) box 100



## G A4 Sheet Protectors

Ultra-clear. Polypropylene. Non-stick and no ink transfer. Colours will not fade. Archival quality. Acid-free. For 8-1/4 x 11-3/4 in. documents. Package of 50.

**GMX PPC3128-50** (833004)



## H Legal Size Page Holders

Polypropylene. Non-stick and no ink transfer. Colours will not fade. Archival quality. Acid-free. Non-glare. Heavyweight. Non-glare.

**GMX PPL3149-10** (416917) pkg 10

**GMX PPL3149** (629253) box 100

## I Rigid Vinyl Sheet Protectors

Oval perforations. 4-hole punched. Not recommended for archiving. Heavyweight. Legal size. Box of 50.

### Ultra-clear

**GMX V-424** (664920) no insert

**GMX V-424-I** (664854) with black insert

### Non-glare

**GMX FV-424** (664904) no insert



## J Legal Size Sheet Protectors

Polypropylene. Acid free archival quality. 4-hole punched. Legal size. Clear. Package of 50.

**WLJ 57110** (1038678)





**A** GEMEX



**B** Wilson Jones

**A Ledger Size Page Holder**

Polypropylene. Non-stick and no ink transfer. Colours will not fade. Archival quality. Acid-free. 11 x 17 in. Package of 10. **GMX PP1117-10** (735712)

**B Ledger Format Sheet Protector**

Reinforced binding edge. Side-loading for secure storage. Heavyweight, non-stick material. Heavyweight. 11 x 17 in. Package of 10. **WLJ 12703** (300731)

**C Ledger Size Sheet Protector**

Top opening. Clear. 11 x 17 in. Package of 10. **VLB 30230** (567354)



**C** vlb



**D** Wilson Jones

**D Extra Capacity Expanding Sheet Protectors**

Super heavyweight. Acid-free, archival safe. Expanding pocket for complete document protection. Top thumb cut. Holds up to 250 sheets. Letter size. 5 mil. Clear. Package of 5. **WLJ 7891021438** (301184)

**E Vinyl Expanding Sheet Protector**

Soft clear vinyl. Thickness: 6 mil. Letter size. Sealed on 3sides, with flap. 3-hole punched. 1 in. expansion. Package of 5. **GMX EXP129** (714683)

**F Expanding Sheet Protectors**

Polypropylene. Top-loading. Reinforced strip. 100-sheet capacity. 3-hole punched. Heavyweight. Clear. Letter size. Package of 25. **BSN 74250** (1038512)



**E** GEMEX



**F** BUSINESS SOURCE

**G Small Size Sheet Protectors**

Polypropylene. Clear. For 8-1/2 x 5-1/2 in. binder. 7-hole punched. Archival safe and acid free. Package of 15. **AVE 77007** (190215)

**H Business card page holder**

Each page holds 20 business cards. Archival quality. Acid-free. Non-stick and no ink transfer. Letter size. **GMX 5-81110-3** (416875) pkg 5  
**GMX 81110-3** (663120) box 50

**I Photo Album Refill**

For 3-ring binders. Archival quality. LetterSize. Package of 10.  
**3-1/2 x 5 in pocket - 8 photos**  
**GMX P355-10** (637991)  
**4 x 6 in pocket - 6 photos**  
**GMX P46-10** (637983)  
**5 x 7 in pocket - 4 photos**  
**GMX P57-10** (637975)  
**4 x 6 in pocket - 8 photos (album size)**  
**GMX P464-10** (737999)



**G** AVERY



**H** GEMEX



**J Trading Card Page Holder**

For sport cards, flash photos, and word-labels. Archival quality. Non-stick and no ink transfer. For 9 trading cards, 2-1/2 x 3-1/2 in. Package of 10. **GMX PH39-10** (679472)



**I** GEMEX



**J** GEMEX



## A Index Maker Label Pocket Dividers

Clear labels. Durable tabs resist tearing. For letter size documents, 3-hole punched. Clear. 5 tabs. Package of 1 set.  
**AVE 78613** (323899)



## B Page Protectors With Tabs

Acid-free, archival safe ultra-clear polypropylene. Set of 5 coloured tabs.  
**GMX IN119-5** (599548)



## C Vinyl Envelope

Soft vinyl. 0.006" thickness. Thumb hole for easy document insertion.

- Package of 10**  
**GMX 235-10** (553503) 2-1/4 x 3-1/2 in.  
**GMX 46-10** (553487) 4 x 6 in.  
**GMX 8511-10** (544148) 8-1/2 x 11 in.  
**GMX 912-10** (539007) 9 x 12 in.
- Package of 50**  
**GMX 35** (114033) 3 x 5 in.  
**GMX 46** (114041) 4 x 6 in.  
**GMX 58** (114066) 5 x 8 in.  
**GMX 69** (114074) 6 x 9 in.  
**GMX 912** (114090) 9 x 12 in.  
**GMX 8511** (114108) 8-1/2 x 11 in.



## D Removable Self-Adhesive Sign Protector Sleeves

Polypropylene. For professional looking displays. With 2 adhesive and removable strips. Package of 10. Letter size.  
**AVE 78620** (698738)



## E Unpunched Top Load Page Holders

Non-stick polypropylene. Holds full sheet insert. Letter size. Box of 50.  
**BSN 37519** (1039718)



## F Sheet Protector With Eyelet

Sturdy vinyl. 0.0075" thickness. Perfect for warehouses, factories and car dealers. Letter size. Package of 50.  
**GMX CW-323** (114025)



## G QuickFit® Shop Ticket Holders

Polypropylene. Double stitched edging. Grommet hole for top hanging. PVC free. 9 x 12 in. Clear. Package of 5.  
**RGO 41305** (1038827)

## H QuickFit® Dry Erase Pocket

Wipes clean with a soft dry cloth or tissue when used with a dry-erase marker (sold separately). Clear on both sides. 9 x 12 in. Package of 10. Assorted colors.  
**RGO 40110** (1038851)



## I Pocket Protector

Heavyweight vinyl. Fits in standard shirt pockets to protect from ink stains. Recyclable. Clear. Package of 50.  
**GMX 356PS** (1072495)





**A** Oxford™



**B** Oxford™



**A 100% Recycled Report Covers**

Recycled stock. 2 inside pockets. Business card holder. 100-sheet capacity. Letter size. 100% post-consumer recycled content.

**Package of 10**

- OXF 00571** (114116) blue
- OXF 00573** (114124) red
- OXF00574** (758433) natural

**Box of 25**

- OXF 78502** (317354) blue
- OXF 78511** (317321) red

**B Twin-Pocket Portfolios**

Leatherette-grained stock. 2 inside pockets. Business card holder. 100-sheet capacity. Letter size. Box of 25. 10% post-consumer fibre.

**2 pockets**

- OXF 57501** (240192) light blue
- OXF 57502** (240200) dark blue
- OXF 57503** (240218) green
- OXF57504** (538330) white
- OXF 57506** (240226) black
- OXF 57509** (240234) yellow
- OXF57510** (538298) orange
- OXF 57511** (240283) red
- OXF57538** (831169) grey

**2 pockets and 3 fasteners**

- OXF 57701** (831171) light blue
- OXF 57702** (831172) dark blue
- OXF 57703** (831173) green
- OXF 57711** (831174) red
- OXF67505** (831170) grey



**C** Oxford™



**D** Oxford™

**C Report Covers**

Leatherette-grained stock. 3 fasteners. Embossed title panel on front cover. 100-sheet capacity. Letter size. Box of 25. 10% post-consumer fibre.

- OXF52501** (240077) light blue
- OXF 52502** (240085) dark blue
- OXF52503** (240093) green
- OXF52506** (240143) black
- OXF52511** (240176) red

**D Tri-Fold Report Covers**

Card Stock. 3 inside pockets fold up to letter size. Business card holder. Holds 50% more than standard pocket folder. 150-sheet capacity. Letter size. Box of 20.

- OXF 59802** (114132) dark blue
- OXF59806** (594127) black
- OXF 59811** (114157) red

**E Divide-It-Up™ 4-Pocket Poly Report Cover**

4 pockets in one folder (3 on right; 1 on left). Pocket-Lok feature. 110-sheet capacity. Letter size. Package of 5. Assorted colours. **OXF 99800** (226266)



**E** Oxford™



**F** Oxford™

**F ViewFolio™ Tri-Pocket Portfolio**

Display window frames cover pages. Made of durable polypropylene that is wear, tear and moisture resistant. Accepts letter/legal and tabloid sizes. Sold by each. Blue. **OXF 77627** (598268)

## A Report Cover

Laminated cardboard. 3 fasteners. 2 inside pockets. 80-sheet capacity. Letter size. Sold by each.

- GCI 34200BK** (737239) black
- GCI 34200BE** (737221) light blue
- GCI 34200DBE** (737247) royal blue
- GCI 34200DGN** (737254) dark green
- GCI 34200GN** (737262) green
- GCI 34200GY** (737270) grey
- GCI 34200OR** (737288) orange
- GCI 34200PE** (737296) purple
- GCI 34200PK** (222505) pink
- GCI 34200RD** (737304) red
- GCI 34200TE** (737312) turquoise
- GCI 34200WH** (737320) white
- GCI 34200YE** (737338) yellow

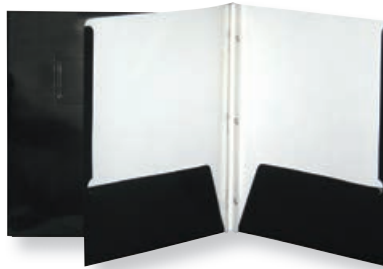
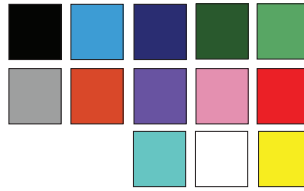

## B Report Cover

Laminated cardstock. 3 metallic fasteners. Capacity of 100 sheets. Letter size. Sold by each.

- GCI 34000BE** (101022) blue
- GCI 34000BK** (100917) black
- GCI 34000DBE** (100925) royal blue
- GCI 34000DGN** (101055) dark green
- GCI 34000GN** (101063) green
- GCI 34000GY** (101071) grey
- GCI 34000OR** (100966) orange
- GCI 34000PE** (100974) purple
- GCI 34000PK** (222489) pink
- GCI 34000RD** (100982) red
- GCI 34000TE** (100990) turquoise
- GCI 34000YE** (213991) yellow

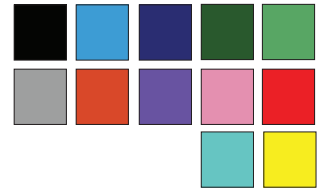

## C Report Cover

Laminated cardstock. 2 inside pockets. Business card holder. 80-sheet capacity. Letter size. Vendu à l'unité.

- GCI 34400BE** (758300) light blue
- GCI 34400BK** (758318) black
- GCI 34400DBE** (758326) royal blue
- GCI 34400DGN** (758334) dark green
- GCI 34400GN** (758342) green
- GCI 34400GY** (758359) grey
- GCI 34400OR** (758367) orange
- GCI 34400PE** (758375) purple
- GCI 34400PK** (222513) pink
- GCI 34400RD** (758383) red
- GCI 34400TE** (758391) turquoise
- GCI 34400WH** (758409) white
- GCI 34400YE** (758417) yellow



## D Showfolio™ Twin Pocket Portfolios

Laminated cover stock. 2 interior pockets. Reinforced sides and top resist tearing. Business card holder. 100-sheet capacity. Letter size. Box of 25.

- OXF 51701** (290874) royal blue
- OXF 51704** (240028) white
- OXF 51706** (240036) black
- OXF 51711** (240044) red
- OXF 51743** (240069) dark blue



## E Report Cover

Laminated cover stock. 2 interior pockets. Business card holder. 50-sheet capacity. Letter size. Box of 25. 100% recycled content.

- OXF PPF-DBN/B** (557330) navy
- OXF PPF-DBU/B** (557355) red
- OXF PPF-DBZ/B** (557363) white
- OXFPFF-DBP/B** (557348) green





**A Twin-Pocket Presentation Folder**

Lightly-textured cardboard. 2 inside pockets. Letter size. Sold by each. 10% post-consumer content.

- HLR06004** (222745) yellow
- HLR06005** (113381) dark blue
- HLR06006** (113399) green
- HLR06007** (113407) red
- HLR06010** (113415) white
- HLR06011** (113423) grey
- HLR06026** (222752) light blue
- HLR06035** (222760) black

**B Report Cover**

Lightly-textured cardboard. 3 fasteners. Letter size. Sold by each.

- HLR06203** (222778) orange
- HLR06204** (3384) yellow
- HLR06209** (222786) dark blue
- HLR06211** (222802) light grey
- HLR06212** (222794) white
- HLR06224** (222810) green
- HLR06226** (222828) light blue
- HLR06235** (222844) black
- HLR06237** (3392) red
- HLR06249** (419291) assorted colours



**C Recycled Report Covers**

Acid and chlorine free. 3 fasteners. Letter size. Box of 25. 100% post-consumer recycled content.

- HLR 06836** (550582) yellow
- HLR 06828** (550574) red
- HLR 06848** (550590) blue
- HLR 06850** (550608) green

**D Report Covers**

2 insides pockets and 3 fasteners. Business card holder. 100-sheet capacity. Letter size. Box of 25. 10% post consumer recycled content.

- BSN 78532** (1037019) black
- BSN 78508** (1037027) blue
- BSN 78510** (1037035) red



**E Lockit® Pocket Folders**

Heavyweight textured folder. 2 pockets. Business card holder. Letter size. Package of 25. 10% post-consumer recycled content.

- SMD 87981** (1036722) black
- SMD 87982** (1036730) dark blue

**F Pocket Portfolios**

2 insides pockets. Business card holder. 100-sheet capacity. Letter size. Box of 25. Assorted colours. 10% post-consumer recycled content.

- BSN 78502** (1036995)



**G Report Cover**

Cardboard back cover. Clear poly front. 3 fasteners. 1/2 in. capacity. Letter size. Sold by each.

- OXF55806** (678110) black
- OXF 55801** (678102) light blue
- OXF 55811** (678128) red
- OXF55838** (101014) dark blue
- OXF 55856** (100875) green

**H Clear Front Report Covers**

Cardboard back cover. Clear poly front. 3 fasteners. 100-sheet capacity. Letter-size. Box of 25.

- BSN78519** (1037084) assorted colours
- BSN 78520** (1037092) black
- BSN 78522** (1037100) blue
- BSN 78523** (1037118) red



## A Report Cover

Polypropylene. Letter size.

**3 fasteners**

GCI PFDT-BE (724302) blue

GCI PFDT-BK (681429) black

GCI PFDT-GN (724310) green

GCI PFDT-RD (724328) red

**2 pockets and 3 fasteners**

GCI PFDT2-BE (724377) blue

GCI PFDT2-BK (724385) black

GCI PFDT2-GN (724393) green

GCI PFDT2-RD (724401) red

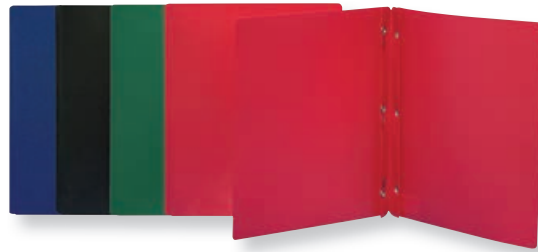

## B Report Cover

Polypropylene. Clear front pocket. Business card holder. Letter size.

**2 pockets**

GCI PFPL2ST-BE (737866) blue

GCI PFPL2ST-BK (737874) black

GCI PFPL2ST-GN (737882) red

GCI PFPL2ST-RD (737940) red

**2 pockets and 3 fasteners**

GCI PFDT2ST-BE (737817) blue

GCI PFDT2ST-BK (737825) black

GCI PFDT2ST-GN (737833) green

GCI PFDT2ST-RD (737841) red



## C Double Stuff® Twin Pocket Portfolios

Durable opaque polypropylene. 2 gusseted 6" high pockets allow for extra capacity. 200-sheet capacity, twice the standard quantity. Letter size.

OXF 57454 (775486) black

OXF 57455 (775494) navy

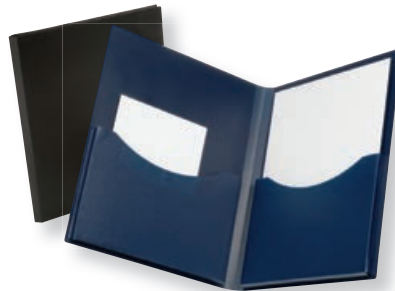

## D Report Cover

Plastic. 3 fasteners. 2 pockets. Snap button closure. Assorted colours.

GCI 33000 (106898)



## E Report Covers

Polypropylene. 80-sheet capacity. Letter size. Package of 5. Clear.

WNN 5TSE310LCR (549949) 2 pockets

WNN 5TC02CR (549956) 3 fasteners



## F Legal Size Report Cover

Textured polypropylene. 14 x 8-1/2 in. 2 inside pockets.

Business card holder. Black.

WNN RP19L-BK (786657)



Legal size

## G Ledger Size Report Cover

Polypropylene. 11 x 17 in. Acid-free, transfer-safe. 3 fasteners.

30-sheet capacity. Black.

CRD 94910 (236489)



Ledger size





**A Winnable**



**B Winnable**



**A Report Cover**

Supple polypropylene. Translucent. 2 inside pockets. 80-sheet capacity. Letter size.  
**WNN TSE-310LCR** (737957) clear  
**WNN TSE-310LBE** (737965) blue  
**WNN TSE-310LGN** (737973) green  
**WNN TSE-310LRD** (737981) red

**B Report Cover**

Supple polypropylene. Translucent. 3 fasteners. Letter size.  
**WNN TC02-CR** (737908) clear  
**WNN TC02-BE** (737916) blue  
**WNN TC02-GN** (737924) green  
**WNN TC02-RD** (737932) red

**C Report Cover**

Polypropylene. 2 inside pockets. Letter size.  
**GCI PFPL2-BK** (724344) black  
**GCI PFPL2-BE** (724336) blue  
**GCI PFPL2-GN** (724351) green  
**GCI PFPL2-RD** (724369) red



**C GEO**



**D Oxford™**

**D Viewfolio Twin Pocket Portfolio**

Top-loading, framed window displays cover page. Business card holder. Extra durable poly. Holds up to 100 sheets. Letter size.  
**OXF 57441C** (317362) blue  
**OXF 57442C** (317388) black

**E Poly Tang Report Cover**

Polypropylene. 2 inside pockets. 3 fasteners. Business card holder. 80-sheet capacity. Letter size.  
**WNN TCP04-DB** (717389) dark blue  
**WNN TCP04-BK** (717397) black  
**WNN TCP04-BY** (738021) red  
**WNN TCP-04-DG** (738013) green

**F Poly Portfolio**

Polypropylene. Business card holder. 100-sheet capacity. Letter size.  
**2 pockets**  
**OXF 76015** (1036862) black  
**OXF 76016** (1036896) orange  
**OXF 76017** (1036888) green  
**OXF 76018** (1036912) red  
**OXF 76019** (1036870) blue  
**OXF 76020** (1036920) yellow  
**OXF 76021** (1036904) purple  
**2 pockets and 3 fasteners**  
**OXF 76022** (1036797) black  
**OXF 76023** (1036821) orange  
**OXF 76024** (1036813) green  
**OXF 76025** (1036847) red  
**OXF 76026** (1036805) blue  
**OXF 76027** (1036855) yellow  
**OXF 76028** (1036839) purple



**G Poly Portfolio**

Polypropylene. 30-sheet capacity. 2 insides pockets. Business card holder. Letter size.  
**BSN 20880** (1036763) blue  
**BSN 20878** (1036756) yellow  
**BSN 20879** (1036748) purple  
**BSN 20881** (1036789) red



**E Winnable**



**F Oxford™**



**G BUSINESS SOURCE®**

## A Report Cover

Polypropylene. Clear front. 3 fasteners. 80-sheet capacity. Letter size.

- WNN TCC-05BK** (717439) black
- WNN TCC-05BE** (717447) blue
- WNN TCC-05DB** (717454) dark blue
- WNN TCC-05GN** (717470) green
- WNN TCC-05RD** (717462) red
- WNN TCC-05AD** (101188) assorted colours



## B DURACLIP® Report Cover

Sturdy vinyl with clear front. Patented clip that expands to hold contents securely. Five-year clip warranty. No perforation required. Letter size.

**30-sheet capacity**

- DBL 220301** (666628) black
- DBL 220303** (666644) red
- DBL 220307** (666636) dark blue
- DBL 220332** (136853) dark green
- DBL 220357** (775668) graphite

**60-sheet capacity**

- DBL 221401** (666677) black
- DBL 221407** (666669) dark blue



## C Swinglock Report Cover

Frosted polypropylene. With clip. No perforation required.

30-sheet capacity. Letter size.  
**GBC 43361** (665695)



## D Swing Clip® Report Cover

Polypropylene. Clip securely holds papers together.

30-sheet capacity. Clear.  
**WNN RP910** (1037340) letter  
**WNN RP915** (1037332) legal

## E Report Cover

Polypropylene. With side spring-action clamp. 1 inside pocket with perforation for business card. No perforation required.

100-sheet capacity. Letter size. Clear.  
**WNN BDR-01-CR** (701326)



## F Vinyl Report Cover

Translucent. Open on 3 sides. 0.0045" thick. Double acetate type. Spines sold separately.

**Letter size - box of 25**

- GMX PC527-C25** (114645) clear
- GMX PC527-B25** (114637) blue
- GMX PC527-G25** (114652) green
- GMX PC527-R25** (114660) red
- GMX PC527-Y25** (114686) yellow

**Letter size - box of 100**

- GMX PC-527-C** (347591) clear
- GMX PC410-C** (563114) clear

**Legal size - box of 100**

- GMX PC514-C** (114629) clear
- **11-1/4 in. spines - 15-sheet capacity (pkg 25)**
- GMX TB11-8BK** (481804) black
- GMXTB11-8B** (481796) blue
- GMX TB11-8W** (481838) white
- **11-1/4 in. spines - 25-sheet capacity (pkg 25)**
- GMXTB11-4B** (481739) blue
- GMX TB11-4BK** (481747) black
- GMX TB11-4W** (481770) white
- **11-1/4 in. spines - 30-sheet capacity (pkg 25)**
- GMXTB11-2BK** (563031) black
- **14-1/4 in. spines - 25-sheet capacity (pkg 25)**
- GMX TB14-4BK** (481853) black





**A** Cardinal®

**A Presenter Binder**

On the vertical side, bottom half of binder swings back from ring to form easel stand. On horizontal format, cover folds back to hold binder secure when in use. 1 in. capacity. For 8-1/2 x 11 in. documents. Black.  
**CRD 09260** (1034123)



**B** Cardinal®

**B Custom Showfile™ Presentation Book**

Polypropylene. Customizable cover and spine. Sheet protector-style pages are bound in book. No ink transfer. Letter size. Black.  
**CRD 50132CB** (1037274) 12 pockets  
**CRD 50232** (1037282) 24 pockets

**C SpineVue™ ShowFile™ Presentation Book**

Polypropylene. Overlay design allows for one-piece inserts for cover, spine and back. Sheet protector-style pages are bound in book. No ink transfer. 12 pockets. Letter size. Black.  
**CRD 51132CB** (1037290)

**D Document Saver™ Display Album**

Polypropylene. Clear front pocket. Protective inside pockets. Letter size.

- 10 pockets**
- WNN LM10-BE** (738039) blue
- WNN LM10-BK** (738047) black
- 20 pockets**
- WNN LM20-BE** (738054) blue
- WNN LM20-BK** (738062) black
- 40 pockets**
- WNN LM40-BK** (420521) black



**C** Cardinal®



**D** Winnable

**E ReportPro® Project Organizer**

Polypropylene. 10 pockets. 4 insertable tab dividers. Business card holder. 200-sheet capacity. Letter size. Black.  
**CRD 13601** (1037043)

**F 8-Pocket Organizer**

Polypropylene. Translucent. Contemporary textured cover and back finish. Twin-wire binding. 8 pockets. 25-sheet capacity per pocket. Letter size.  
**OXF 58408-23** (701128) blue  
**OXF 58408-58** (701136) red  
**OXF 58408-60** (701144) green



**E** Cardinal®



**F** Oxford™

## A ACCO Presstex® Data Binder

Acrylic coated pressed cardboard. Two-piece hanging data binder. Resists humidity. 6 in. capacity. Burst or unburst forms. Blue. 50% recycled content, 30% post-consumer waste.

**ACC A7054052A** (133) 8-1/2 x 11 in.

**ACC A7054122A** (766204) 11 x 8-1/2 in.

**ACC A7054042A** (209981) 14-7/8 x 8-1/2 in.

**ACC A7054072A** (209908) 14-7/8 x 11 in.

## B ACCOHIDE® Data Binder

Poly two-piece hanging data binder. Unburst forms. Blue. 25% post-consumer waste.

**ACC 5050556003** (39248) 9-1/2 x 11 in.

**ACC 5050556113** (1396) 14-7/8 x 11 in.

## C Presstex® Reinforced Report Cover

20 pt cover stock. Resists to moisture. Leather embossed, coated cover stock. Colour-matched reinforced Tyvek® hinges. ACCO® fastener secures thin or thick documents. 60% recycled content, 30% post-consumer waste.

**11 x 8-1/2 in.**

**ACC 25071** (300624) black

**ACC 25072** (300632) blue

**ACC 25073** (324632) royal blue

**ACC 25079** (300640) red

**14 x 8-1/2 in.**

**ACC 30071** (261040) black

**11 x 17 in.**

**ACC 47071** (261073) black

## D Pressboard Report Cover

20 pt. pressboard cover. Colour-matched reinforced Tyvek® hinges. Acco® fastener secures thick or thin documents. Recycled content: 60%, post-consumer: 30%.

**8-1/2 x 11 in. - 2 in. capacity**

**ACC17021** (262394) black

**8-1/2 x 14 in. - 2 in. capacity**

**ACC19921** (262436) black

**11 x 8-1/2 in. - 3 in. capacity**

**ACC 25971** (251785) black

**ACC 25972** (251793) light blue

**ACC 25973** (251801) dark blue

**ACC 25979** (251843) executive red

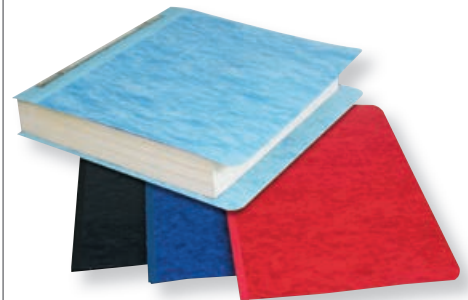
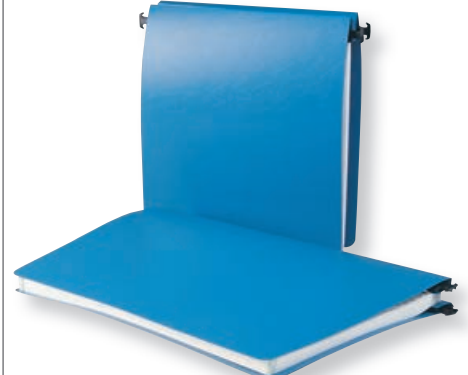
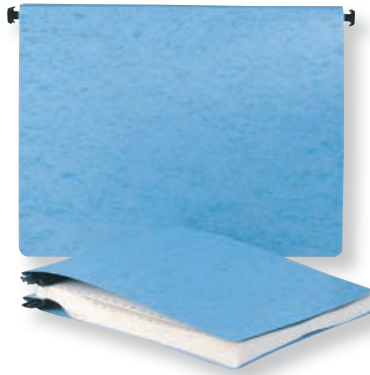

<p>Antimicrobial protection</p> <p><b>N</b> 2023</p>  <p><b>A</b> <b>WESTCOTT</b> Depuis 1872 Since 1872*</p>	<p><b>N</b> 2023</p>  <p><b>B</b> <b>vlb</b></p>	<p><b>N</b> 2023</p>  <p><b>C</b> <b>BUSINESS SOURCE</b></p>	<p><b>A Antimicrobial Plastic Clipboard</b> Plastic parts contain an antimicrobial agent. Letter size. Blue. <b>ACM 37920</b> (827677)</p> <p><b>B Duraply Clipboard</b> Strong polypropylene. Acid free. Spring clip. PVC free. Black. <b>VLB98981</b> (1039312) letter <b>VLB 98982</b> (1039304) legal</p> <p><b>C Shatterproof Clipboard</b> Shatterproof, high-impact plastic. Letter size. Black. <b>BSN 49269</b> (1039577)</p> <p><b>D Clipboard</b> Polypropylene. Letter size. <b>GCI246967</b> (246967) blue <b>GCI PCB14811GN</b> (246976) green <b>GCI PCB14811OR</b> (246991) orange <b>GCI PCB14811PK</b> (247007) pink <b>GCI PCB14811RD</b> (247015) red <b>GCI PCB14811YE</b> (246983) yellow</p>
 <p><b>D</b> <b>GEO</b></p>			<p><b>E Recycled Clipboard</b> Polypropylene. Letter size. 100% post-consumer recycled content. <b>STX 41101B12C</b> (135954) blue <b>STX 41103U12C</b> (135962) silver</p> <p><b>F Plastic Clipboard</b> Durable, lightweight material. Letter size. <b>ACM 37911</b> (282590) smoke <b>ACM 37912</b> (282608) clear <b>ACM 37917</b> (486944) granite</p>
<p> </p>  <p><b>E</b> <b>STOREX</b></p>	 <p><b>F</b> <b>WESTCOTT</b> Depuis 1872 Since 1872*</p>	<p><b>G Recycled Plastic Clipboard</b> Letter size. 90% post-consumer recycled content. <b>NAT01540</b> (1039502) black <b>NAT 01541</b> (1039528) Red <b>NAT 01542</b> (1039510) Blue</p> <p><b>H Clearview Insert Clipboard</b> Clipboard and display board in one. Display and protect reference sheets in the insert cover. Letter size. <b>WLJ 42404</b> (244160)</p> <p><b>I Durably Clipboard</b> Ultra durable polypropylene. 11 x 17 in. Black. <b>VLB 98984</b> (579722)</p>	
 <p><b>E</b> <b>STOREX</b></p>	<p></p>  <p><b>G</b> <b>naturesaver</b></p>	<p><b>H Clearview Insert Clipboard</b> Clipboard and display board in one. Display and protect reference sheets in the insert cover. Letter size. <b>WLJ 42404</b> (244160)</p> <p><b>I Durably Clipboard</b> Ultra durable polypropylene. 11 x 17 in. Black. <b>VLB 98984</b> (579722)</p>	
 <p><b>H</b> <b>wilson jones</b></p>	<p>Ledger size</p>  <p><b>I</b> <b>vlb</b></p>	<p><b>H Clearview Insert Clipboard</b> Clipboard and display board in one. Display and protect reference sheets in the insert cover. Letter size. <b>WLJ 42404</b> (244160)</p> <p><b>I Durably Clipboard</b> Ultra durable polypropylene. 11 x 17 in. Black. <b>VLB 98984</b> (579722)</p>	

## A Aluminium Clipboard

Contoured clip with rubber corners. 1/2 in. paper capacity. Integrated holes for hanging.  
**GCI K8511A** (596346) letter  
**GCI K8514A** (596353) legal



**A** **GEOCAN**  
CONCEPTION & DESIGN

## B Aluminum Clipboard

For demanding environments. 6 in nickel-plated steel clip. Rounded corners.  
**ACM 38120** (790659) letter  
**ACM 38125** (790667) legal



**B** **WESTCOTT**  
Depuis 1872 Since 1872



**C** **B** **BUSINESS SOURCE**®

## C Aluminium Clipboard

Rounded corners. Strong clamp with built-in hanging clip. Letter size. Silver.  
**BSN 86259** (1039255)

## D Masonite Clipboard

Durable lightweight material. Strong spring clip. Hang up hole. 100% recycled masonite.  
**GCI K6090M** (597625) 6-1/4 x 9 in.  
**GCI K8611M** (596361) 9 x 12 in.  
**GCI K8614M** (596379) 9 x 15 po

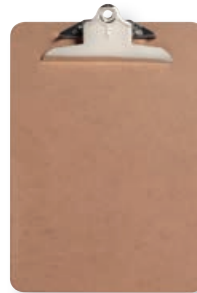

**D** **GEOCAN**  
CONCEPTION & DESIGN



## E Masonite Clipboard

Smooth surface on each side. Built-in handle. 2 clips with rubber corners. 19 x 14-1/2 in. 100% recycled masonite.  
**GCI K1914M** (596387)



**E** **GEOCAN**  
CONCEPTION & DESIGN



## F Masonite Arch Clipboard

Masonite. Rounded smooth corners. Durable lightweight material. 70% recycled material and 30% post-consumer content.  
**ACM 35812** (235556) letter  
**ACM 35815** (235549) legal

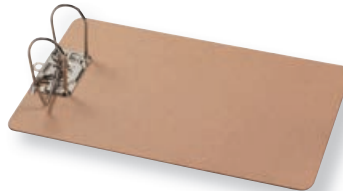

**F** **WESTCOTT**  
Depuis 1872 Since 1872



## G Plastic Clip Board

Pull out tab for hanging. Screen printed metric/imperial ruler on each side. Letter size.  
**9 x 12 in.**  
**BSN 01869** (1039437) clear  
**BSN01870** (1039445) smoke  
**BSN49265** (1039338) silver  
**12 x 9 in.**  
**BSN49266** (1039346) silver



**G** **B** **BUSINESS SOURCE**®

## H Plastic Clip Board

Durable moulded plastic. Screen printed ruler on each side. Letter size.  
**BSN01863** (1039453) blue  
**BSN 01860** (1039478) clear  
**BSN01861** (1039494) smoke



**H** **B** **BUSINESS SOURCE**®

## I Mini Plastic Clipboard

Durable plastic. 6 x 9 in. Clear.  
**BSN 01858** (1039411)

Small size



**I** **Sparco**™



**A** **GEOCAN**  
CONCEPTION & DESIGN



**B** **WESTCOTT**  
Depuis 1872 Since 1872\*

**A Aluminium Form Holder**

1/2 in. capacity metal clamp. Lateral opening with 3/8 in. compartment to protect your documents.  
**GCI A5095A** (596395) 5-2/3 x 9-1/2 in.  
**GCI A9012A** (596403) 9-1/8 x 12-5/8 in.

**B Side Hinged Sheet Holder**

Durable aluminum. Durable steel clips lock your documents in place and aid in reducing slippage while completing the forms. 30 sheet capacity. Letter size.  
**ACM 38012** (790618)

**C Aluminium Sheet Holder**

Top opening. With metal clamp on top. Inside form holder. For letter size document.  
**GCI A1490A** (596437)



**C** **GEOCAN**  
CONCEPTION & DESIGN



**D** **GEOCAN**  
CONCEPTION & DESIGN

**D Form Holder with Handle**

Polypropylene. Antimicrobial. Bottom opening for convenient access. Large smooth writing surface. Large internal storage space. Strong nickel-plated steel spring clip with rubber corner grips on the top. Letter size. Black.  
**GCI K8511P** (596411) without calculator  
**GCIK8611CP** (596429) with calculator

**E Form Holder**

Polypropylene. Internal document clip can be attached to the right or left. Strong nickel-plated steel spring clip with rubber corner grips on the top. Letter size. Grey.  
**GCI K8711P** (596445)

**F Plastic Forms Holder with Storage**

Flat Clip board with internal storage. Chrome clip with black plastic protectors on corners to protect document. Letter size. Black.  
**BSN 37513** (1039619)



**E** **GEOCAN**  
CONCEPTION & DESIGN



**F** **B BUSINESS SOURCE**

**G Portfolio**

Vinyl. Alligator clip. 2 inside pockets. Side opening. 100-sheet capacity.  
**Letter size**  
**RG0 306852** (306852) black  
**RG0 306860** (306860) blue  
**Legal size**  
**RG0 306886** (306886) black

**H Poly Writing Case**

Polypropylene. Archival quality. Acid-free. With quick-release top spring-action clamp. Inside pocket. PVC Free. 100-sheet capacity.  
**8-1/2 x 11 in.**  
**VLB98985** (135921) black  
**VLB 98986** (135939) blue  
**8-1/2 x 14 in.**  
**VLB 98987** (135947) black  
**11 x 17 in.**  
**VLB 69845** (596940) black

**I Deluxe Portfolio/clipboard**

Vinyl. 2 inside pockets. Side opening. 100-sheet capacity. Letter size. Black.  
**RG0 D451101** (523357)



**G** **DAVIS GROUP**



**H** **vlb**



**I** **DAVIS GROUP**





# Swingline®

## 747® BUSINESS STAPLERS

THE STAPLERS YOU'VE ALWAYS LOVED,  
NOW WITH A NEW DESIGN AND EVEN MORE POWER

### What You Have Always Loved

- Same heavy-duty metal construction
- Always deliver Jam Free, accurate stapling
- Durability guaranteed with Limited Lifetime Warranty

### What's New

- Sleeker and modern design
- Direct-Impact technology (DIT) to improve stapling performance
- Stapling capacity increased to 30 sheets



©2022 ACCO Brands.  
All rights reserved.  
C124\_22\_P





**A** **Rapid**



**B** *Swingline*



**A 5050 Electric Stapler**

Staples up to 60 sheets at a time. Low profile to fit in a drawer. Front loading system. Rubber feet for great stapling precision. AC powered. 2-year limited warranty.  
**RPD 73157** (291476)  
 • Staples (5000)  
**RPD 73158** (291468)

**B Optima® 70 Electric Stapler**

Staples 2-70 sheets at a time. Flip-up staple placement guides for stack alignment. LED indicator informs user when staples are running low. Flat-clinch mechanism. Staple storage drawer. Battery backup. 5-year limited warranty. Silver/black.  
**SWI 48210** (787275)  
 • Staples (2500)  
**SWI 35550** (481903)



**C** *Swingline*



**D** *Swingline*



**C 690 Electric Stapler**

Patented long-lasting cartridge technology for 5,000 staple cycles without reloading. Depth adjustment guides. Staples up to 30 sheets. Suction cup feet. Simple cartridge load and unload. 2-year limited warranty. Black.  
**SWI 69008** (186684)  
 • Staples (5000)  
**SWI 50050** (656181)

**D Optima® 20 Full Strip Electric Stapler**

Auto or manual user mode. Staples 2-20 sheets at a time. LED indicator informs user when staples are running low. Detachable staple remover. Battery back up. 5-year limited warranty.  
**SWI 48208** (787291)  
 • Staples (3750)  
**SWI 35556** (116590)



**E** *Swingline*



**F** **BOSTITCH**



**E Optima® 45 Full Strip Electric Stapler**

Staples 45 sheets at a time. Jam free stapling guaranteed. LED indicator informs user when staples are running low. Flat-clinch mechanism. Staple storage drawer. Battery back up. 5-year limited warranty. Silver/black.  
**SWI 48209** (136127)  
 • Staples (3750)  
**SWI 35556** (116590)

**F B8® Impulse 45™ Electric Stapler**

Impulse Drive™ design for 3X faster stapling. No-Jam™ technology. Staples up to 45 sheets. Staple indicator light. Push-button FastLoad™. 5,000 staples included. 7-year limited warranty.  
**BOS B8E-VALUE** (529784)  
 • Staples (5000)  
**BOS STCRP2115** (9381)



**G** *Swingline*



**H** **Rapid**



**G Optima® Grip Half Strip Electric Stapler**

Staples up to 20 sheets. Compact size. Manual or automatic activation. Comfortable grip. Plug-in or battery operation. 2-year limited warranty.  
**SWI 48207** (787283)  
 • Staples (3750)  
**SWI 35556** (116590)

**H 20EX Electric Stapler**

Staples up to 20 sheets at a time. Low profile to fit in a drawer. Power adapter included. Front loading system. Rubber feet for great stapling precision. Contemporary design. Black.  
**RPD 73126** (560219)

## A Impulse 25™ Electric Stapler

Exclusive Impulse Drive™ for 3X faster stapling. No-Jam™ technology. Staples up to 25 sheets. Refill alert light. FastLoad™ push-button refill system. 7-year limited warranty. Black.

**BOS 02210** (529792)  
 • Staples (5000)  
**BOS SBS1914CP** (327106)



## B Breeze Automatic Half Strip Stapler

Durable plastic construction. Small footprint. Automatically staples up to 20 sheets. Powered by 6 AA batteries (not included). 1-year limited warranty. Black/white.

**SWI 42132** (116053)  
 • Staples (3750)  
**SWI 35454** (439778)

## C 900XD High Capacity Heavy-Duty Stapler

Staples from 2-210 sheets. Easy grip handle. Throat depth adjusts to 2-1/2 in. Lever on front plate for unjamming. All-metal construction. Large rubber feet. Limited lifetime warranty.

**SWI 90002** (396663)  
 • Staples (1000)  
**SWI 35314** (262931) 1/4" (15-30 sheets)  
**SWI 35318** (262949) 3/8" (25-60 sheets)  
**SWI 35312** (261057) 1/2" (40-90 sheets)  
**SWI35319** (740522) 3/4" (90-160 sheets)  
**SWI 35320** (740530) 15/16" (130-210 sheets)

**A** **BOSTITCH**



**B** *Swingline*



## D LightTouch® Heavy-Duty Stapler

Uses a single unique staple to bind stacks of 20-120 sheets. Requires 50% less effort. Metal construction. Soft-touch materials. Alignment guide. Easy jam-clearing knob. One-button staple loading. Limited lifetime warranty.

**SWI 90010** (700864)  
 • Staples (2500)  
**SWI 90009** (700856)



**C** *Swingline*



**D** *Swingline*



## E Heavy-Duty Stapler

Stapler fastens from 2 to 60 sheet capacity and uses Bostitch SB35 heavy-duty staple sizes: 1/4 in. (2 to 25 sheets) and 3/8 in. (25 to 60 sheets). Lifetime limited warranty. Black.

**BOS 03201** (1032218)  
 • Staples (5000)  
**BOS SB351/4-5M** (1072362) 1/4 po. (2 à 25 feuilles)  
**BOS SB353/8-5M** (1032606) 3/8 po. (25 à 60 feuilles)

## F 390 Heavy-Duty Stapler

Comfortable finger-grip handle. All-metal working components. Staples 2-160 sheets. 2-5/8 in. adjustable throat depth. Limited lifetime warranty. Platinum.

**SWI 39002** (405597)  
 • Staples (1000)  
**SWI 35314** (262931) 1/4" (15-30 sheets)  
**SWI 35318** (262949) 3/8" (25-60 sheets)  
**SWI 35312** (261057) 1/2" (40-90 sheets)  
**SWI35319** (740522) 3/4" (90-160 sheets)



**E** **BOSTITCH**



**F** *Swingline*



## G Antimicrobial Protection Heavy Duty Stapler

All metal construction. Antimicrobial protection. Staples up to 130 or 215 sheets with 4 staple sizes. No-Jam technology. Adjustable paper stop. Rubber feet. Rear staple loading. Lifetime limited warranty. Black.

**BOS B310HDS** (529818) up to 130 sheets  
**BOS 00540** (546812) up to 215 sheets  
 • Staples (1000)  
**BOS SB351/4-1M** (300251) 1/4"  
**BOSSB353/8-1M** (300269) 3/8"  
**BOS SB351/2-1M** (300277) 1/2"  
**BOS SB351316HC** (546838) 13/16"  
**BOS SB355/8-1M** (300186) 5/8"  
**BOS SB351516HC** (546820) 15/16"



**G** **BOSTITCH**



**A** *Swingline*



**B** *Swingline*



**A Omnipress™ S030 Stapler**

Unlike traditional staplers easily staple using less force by pressing anywhere on the stapler body. The SuperFlatCinch technology flattens the staple for 40% flatter paper stacks. Staples up to 30 sheets.  
**SWI 5000586A** (435529) red and black  
**SWI 5000585A** (524785) grey/black

**B Optima® 70 Full Strip Desktop Stapler**

Compact. Requires up to 50% less effort. 70 Sheet capacity. Ergonomic soft touch handle. Compact footprint. Metal mechanism. Flat clinch anvil. Limited lifetime warranty. Silver/black.  
**SWI 87870** (789156)



**C** *Swingline*



**D** *Swingline*



**C Optima® 40 Desktop Stapler**

Up to 50% less effort. Compact, ergonomic shape with soft grips. Metal. Staples up to 40 sheets. Flat-clinch stapling mechanism. Quickload mechanism. Limited lifetime warranty. Silver.  
**SWI 87840** (789149) full strip  
**SWI 19227** (521401) half-strip

**D Easy Touch Lever Stapler**

Full-metal mechanism. Staples up to 60 sheets with 30% reduced effort. 500 staples included. Capacity of 210, 3/8" staples. Black. Limited lifetime warranty.  
**SWI 77701** (481887)

**E Premium Bostitch® Stapler**

PaperPro one-finger stapling technology for 80% easier stapling. Built-in staple remover and staple storage. Jam-free. Metal housing. Staples up to 28 sheets. Capacity of 210 standard staples. Limited 2-year warranty.  
**ACI 1118** (757617) blue  
**ACI 1115** (757609) black  
**ACI 1117** (757591) red



**E** **BOSTITCH**



**F Eco Heavy-Duty Stapler**

Heavy-duty construction. Compact design, powerful stapling. Ergonomic. Adjustable paper stop. Top loads 1/4", 3/8" and 1/2" heavy-duty staples. Black.  
**RPD 73159** (538439) 80 sheets  
**RPD 73140** (524835) 220 sheets

**G Heavy-Duty Desktop Stapler**

Jam-clearing mechanism quickly removes jammed staples. Staples up to 140 sheets. Front-loading holds a strip of 100 staples in six different sizes: 1/4, 5/16, 3/8, 1/2, 9/16 and 5/8 in. Black and grey.  
**BSN 62839** (1032440)



**F** **Rapid**

Find staples on **page 544**



**G** **BUSINESS SOURCE**



## A Optima® 25 Reduced Effort Stapler

Metal. Staples up to 20 sheets. Spring mechanism staples at the push of a finger. Requires half the force of an ordinary stapler. 1-year limited warranty. Full strip of 210 staples. Black/charcoal.  
**SWI 66402** (789131)



**A** *Swingline*

## B NeXt Series Desktop Stapler

Easily staples up to 40 sheets at once. Direct Impact technology ensures you always get a jam-free staple for consistent performance. Stapler also opens for tacking and includes an adjustable anvil for open or closed stapling. Standard staples.

**SWI 55047095** (1032250) black  
**SWI 55047001** (1032291) white  
**SWI 55047023** (1032283) pink  
**SWI 55047036** (1032267) blue  
**SWI 55047044** (1032275) orange



**B** *Swingline*



## C Optima® Grip Upright Stapler

Stands vertically at either end. Lays flat for stapling up to 25 sheets of paper. Comfort grip and ergonomic design. Lifetime limited warranty.

**Half strip, 105 staples**  
**SWI 87815** (758045) black  
**SWI 87816** (758151) silver  
**Full strip, 210 staples**  
**SWI87810** (720219) black  
**SWI87811** (1032473) silver



## D Low Force 35x Stapler

45% reduced effort stapling. Staples 2-35 sheets at a time. Anti-skid rubber base. Ultra flat clinch technology. Re-load indicator. Full-strip of 210 staples. Black.

**SWI 87830** (195214)

**B** *Swingline*

## E 1000 Stapler

Spring mechanism staples up to 20 sheets at the push of a finger. Requires 3 times less effort than an ordinary stapler. Capacity of 210 standard staples. Black/silver.

**ACI 1100** (725366)



## F EcoStapler™ Stapler

PaperPro one-finger stapling technology for 80% easier stapling. Built-in staple remover and staple storage. Jam-free. Capacity of 210 standard staples. Black. 70% post-consumer recycled plastic.

**ACI 1716** (136895)

**C** *Swingline*



## G InJoy™ Spring-Powered Compact Stapler

Spring mechanism staples up to 15 sheets at the push of a finger. Requires 3 times less effort than an ordinary stapler. Capacity of 105 standard staples. Black.

**ACI 1510** (100040)

**D** *Swingline*



**E** **BOSTITCH**



**F** **BOSTITCH**



**G** **BOSTITCH**





**A** *Swingline*



**B** *Swingline*



**A Classic 747 Stapler**

Moulded metal and steel. Rubberized base. Staples up to 20 sheets. Capacity of 210 standard staples. Limited lifetime warranty. Black satin. **SWI 74701** (267237)

**B 747 Business Stapler**

Metal. Rounded base and top. Staples up to 25 sheets. Capacity of 210 standard staples. Limited lifetime warranty. **SWI 74741** (655159) black **SWI74736** (529800) red **SWI 74720** (720201) chrome

**C 545 ECO Stapler**

Plastic. Staples up to 20 sheets. Capacity of 210 standard staples. 50% recycled content. 1-year limited warranty. Black. **SWI 54501** (260133)

**D 310 Swingline Stapler**

Plastic. Rubber base. Staples up to 15 sheets. Capacity of 210 standard staples. Black. **SWI 31001** (383588)



**C** *Swingline*



**D** *Swingline*



**E 646 Stapler**

Plastic with metal base. Staples up to 20 sheets. Capacity of 210 standard staples. Limited lifetime warranty. Black. **SWI 64601** (258905)

**F 310 Economic Stapler**

Metal. Staples up to 25 sheets. Capacity of 210 staples. Limited lifetime warranty. Black. **SWI 31002** (100164)

**G Rapid F30 Stapler**

Compact half-strip design with durable inner metal housing. Flat clinch for 30% flatter paper stacks. Staples up to 30 sheets. Standard staples. Rubber base. Black. **RPD 76082** (531574)



**E** *Swingline*



**F** *Swingline*



**H Offix® MS02-NP Metal Stapler**

Holds a half-strip of standard staples. All-metal construction. 15-sheet capacity. Brushed silver. **NVX 344481** (344481)

**I Business Source® Desktop Stapler**

Sturdy plastic. Features a feeder to prevent jamming. Staples up to 20 sheets. Standard staples. Black. **BSN62835** (1032408)

Find Staples on **page 544**



**G** **Rapid**



**H** **offix**



**I** **BUSINESS SOURCE**



## A LX840™ EasyPress™

### Antimicrobial Stapler

Ergonomic grip. Durable, high-quality staplers for long-lasting, jam-free performance. Offers effortless stapling up to 25 sheets. 3-year limited warranty.

**Half Strip (105 staples)**

**FEL 5010601** (829372) black

**FEL 5011501** (829373) white

**Full strip (210 staples)**

**FEL 5010701** (829374) black

**FEL 5011601** (829375) white

Microban® antimicrobial protection



A

**Fellowes**



Microban® antimicrobial protection



B

**Fellowes**



## B LX820™ Antimicrobial Classic Stapler

Full strip, 210 staples. Staples up to 20 sheets. Durable metal construction. High-quality. Jam-free design. 3-year limited warranty.

**FEL 5010101** (829370) black

**FEL 5011401** (829371) white

## C Antimicrobial Full Strip Stapler

20 sheet capacity. Adjustable anvil. Opens for tacking. Works manually. Up to 210 standard staples. Blue.

**ACM 57150** (827678)

Antimicrobial protection

## D Konnect™ Half Strip Stapler

Staples up to 20 sheets. Storage for extra staples. Integrated ruler and non-skid rubber base. Compact, half-strip design (210 Premium standard staples included). White.

**BOS 829434** (829434)



## E Epic® Executive Antimicrobial Stapler

Antimicrobial protection. Full-strip, 210 staples. Storage for extra staples and staple remover. It stands vertically or horizontally. Staples up to 25 sheets. Lifetime limited warranty. Black.

**BOS B777BLK** (1032341)

## F Antimicrobial Executive Stapler

Die-cast metal. Adjustable dual clinch option for standard or temporary stapling. Staple reload alert window. Standard staples. 20 sheet capacity. Black.

**BOS B5000-BLK** (527507)

C

**WESTCOTT**  
*Depuis 1872 Since 1872*



D

**BOSTITCH**



## G B440 Stapler

Capacity of 210 staples (full strip). All metal construction. Staple level indicator. Opens for tacking. Black.

**BOS B440-BLACK** (300343)

Antimicrobial protection

## H B8 PowerCrown™ Desktop Stapler

Staple up to 40 sheets of paper. Antimicrobial half-strip stapler includes 200 Bostitch B8 PowerCrown 1/4 in. staples. Black.

**BOS B8RC** (9332)

**Flat Clinch with antimicrobial protection**

**BOS B8RCFC-B8** (1032151)

Antimicrobial protection



E

**BOSTITCH**



F

**BOSTITCH**



G

**BOSTITCH**



H

**BOSTITCH**





**A BOSTITCH**



**B** *Swingline*



**A B696 Dynamo™ Stapler**

Staples up to 20 sheets. Integrated pencil sharpener and staple remover. Ergonomic form with soft rubber grip. Stands vertically or horizontally. **BOS B696-BK** (546804) black **BOS829435** (829435) white

**B E-Z Grip™ Half Strip Stapler**

Staples up to 15 sheets at a time. Stands up or lies flat on desktop. Non-slip cushioned hand grip. 1-year limited warranty. Black. **SWI 78890** (673293)

**C Premium Antimicrobial Stand-Up Stapler**

Stands vertically or horizontally. Staples up to 20 sheets. Black. **BOS B326-BLK** (1032374)

**D Vertical Desk Stapler**

Ergonomic stand-up design. Features comfort hand grips and all-metal working parts. Fastens up to 20 sheets. Standard staples. Black and grey. **BSN 65646** (1032432)

Antimicrobial protection



**C BOSTITCH**



**D** **B BUSINESS SOURCE®**



**E Swingline 545 Stapler Kit**

Staples up to 20 sheets. Includes staple remover and staples. **SWI 7471154551** (335141)

**F Business Source® Value Pack Stapler**

Top loading full strip stapler with 20 sheet capacity. Includes 5000 staples and stapler remover. **BSN 41880** (1032531)

**G Long Reach Full Strip Stapler**

Reaches to staple up to 12" away from the edge of the paper. Metal construction. Integrated ruler. Adjustable locking paper guide. Jam-resistant inner rail. 20 sheet stapling capacity. Limited lifetime warranty. **SWI 34121** (278960)

**H Business Source® Long Reach Stapler**

Stapler is adjustable up to 12 in. Stapler staples up to 20 sheets. Standard staples. Dark grey and black. **BSN62827** (1032465)



**E** *Swingline*



**F** **B BUSINESS SOURCE®**



**G** *Swingline*

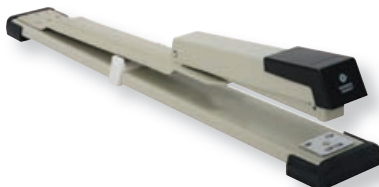

**H** **B BUSINESS SOURCE®**





## A K1 Plier Stapler

Metal mechanism. Staples up to 50 sheets. Capacity of 210 staples. Chrome. 5-year warranty.  
**RPD 90119** (2410)  
 • Staples (5000)  
**RPD 90003** (129106) 5/16"



**A** **Rapid**

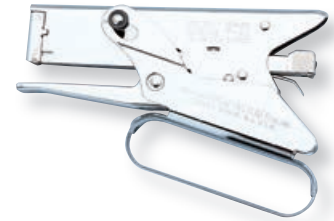

**B** **ARROW**

## B P22™ Plier-Stapler

Heavy-duty metal mechanism. 2-1/2" throat.  
**ARR P22** (211433)  
 • Staples (5000)  
**ARR 225** (3780) 5/16"

## C B8® Heavy-Duty Plier Stapler

All metal construction. No-Jam™ technology. Staples 2-45 sheets. Fast top loading design. Lifetime limited warranty. Black.  
**BOS 02245** (529826)  
 • Staples (5000)  
**BOS STCRP** (9381) 1/4"  
**BOS STCR211538** (474106) 3/8"



**C** **BOSTITCH**



**D** **ARROW**

## D T50® Staple Gun

Heavy-duty metal mechanism. 2-year warranty.  
**ARR T50** (211458)  
 • Staples (1250)  
**ARR 50424SP** (136184) 1/4"  
**ARR 50824SP** (136218) 1/2"  
**ARR 50524SP** (136192) 5/16"  
**ARR 50624SP** (136200) 3/8"

## E Sharpshooter TR150 Staple Gun

Heavy-duty construction. Anti-jam technology. Easy-squeeze handle to reduce fatigue.  
**BOS TR150** (551036)  
 • Staples (1000)  
**BOS TRA708T** (551051) 1/2"



**E** **STANLEY**



**F** *Swingline*

## F Heavy Duty Staple Remover

Spring-loaded lever handle. Durable all-metal construction. Removes all heavy duty staples. Satin chrome finish. 1-year limited warranty.  
**SWI 37201** (482315)

## G KleenEarth® Staple Remover

Contoured handle with soft grip. Magnetized blade. Plastic parts contain an antimicrobial agent. Handle made from 70% recycled materials and 30% post-consumer content. 10-year warranty.  
**ACM 14899** (136176)



**G** **WESTCOTT**  
 Depuis 1872 Since 1872



**H** **BOSTITCH**

## H Magnetic Push Style Staple Remover

Features staple holding feature with a magnetic grip. Removes staples without tearing the paper. 7-year limited warranty. Black.  
**BOS 40000M-BLK** (538520)



## I Staple Remover

Features a pen-style shape for a safe, simple way to remove staples from papers. Made of plastic. Black.  
**BSN 41883** (1032135)



**I** **B** **BUSINESS SOURCE**

## J Lift Type Staple Remover

Paper knife style. Retains removed staples on blade base for easy disposal. Nickel finish.  
**ACM 00552** (220020)



**J** **WESTCOTT**  
 Depuis 1872 Since 1872

## K Claw Style Staple Remover

Plastic and metal construction. Mahogany.  
**ACM 21550** (15230)



**K** **WESTCOTT**  
 Depuis 1872 Since 1872



**L** **offix**



## L Offix® Staple Remover

Heavy-duty steel jaws. Black.  
**NVX 344994** (344994)



BRAND	CODE	REFERENCE	DESCRIPTION	FOR USE IN	CROWN WIDTH	LEG LENGTH	STAPLES PER BOX	PRICE
Offix	NVX 344473	344473	Standard Chisel Point	Standard Staplers	1/2"	1/4"	5000	
Bostitch-PaperPro	ACI 1913	1032614	1/2" Heavy Duty Staples	Heavy Duty Staplers - Up to 100 Sheets	1/2"	1/2"	1000	
Bostitch-PaperPro	ACI 1962	757641	3/8 Heavy-Duty Staples	Heavy-Duty Staplers - Up to 70 sheets	1/2"	3/8"	3000	
Rapid	RPD 90220	646125	Cartouche agrafes, 2-90 feuilles	Agrafeuse électrique 5080e	-	-	5000	
Rapid	RPD 73158	291468	Staple Cartridge, 2-90 Sheets	5080e Electric Stapler	-	-	5000	
Rapid	RPD 73339	662015	Staple Cartridge, 60 Sheets	5050e Electric Stapler	1/2"	3/4"	1000	
Rapid	RPD 02897	587253	K6 (Blue) Staple Cartridge, 2-25 Sheets	02892 Heavy Duty Cartridge Stapler	1/2"	1/4"	1050	
Rapid	RPF 02900	587097	K8 (Yellow) Staple Cartridge, 26-40 Sheets	02892 Heavy Duty Cartridge Stapler	1/2"	5/16"	1050	
Rapid	RPD 02903	587261	K10 (Green) Staple Cartridge, 41-55 Sheets	02892 Heavy Duty Cartridge Stapler	1/2"	13/32"	1050	
Rapid	RPD 02904	587279	K12 (Red) Staple Cartridge, 56-80 Sheets	02892 Heavy Duty Cartridge Stapler	1/2"	15/32"	1050	
Rapid	RPD 90003	129106	High Cap ty 5/16" Staples	100E, 90E, K2, S50, Classic 1 Pliers, HD12 Long Arm	1/2"	5/16"	5000	
Swingline	SWI 35556	116590	Optima Premium Staples	Optima 48207, 48208, 48209, 87800, 87801, 87811, 87840	1/2"	1/4"	3750	
Swingline	SWI 50050	656181	5000 Cartridge	69008	1/2"	1/4"	5000	
Swingline	SWI 69495	380246	SF227 H.D. Cartridge	69270	1/2"	3/8"	5000	
Swingline	SWI 35319	740522	SF13- 3/4"- 1M H.D., Chisel (90-160 Sheets)	90002, 11302, 39005, 39002,	1/2"	3/4"	1000	
Swingline	SWI 35320	740530	SF13- 15/16"- 1M, Chisel (130-210 Sheets)	900XD, 00540, 390, 224xHD, 415	-	5/16"	1000	
Swingline	SWI 35454	439778	SF4 Premium Staples	All Standard Staplers	1/2"	1/4"	3750	
Swingline	SWI 7471135442	1032656	SF3 Premium	Compact, Half Strip Staplers	-	1/4"	3750	
Swingline	SWI 35108	176594	SF1 Standard, Chisel	All Standard Staplers	1/2"	1/4"	5000	
Swingline	SWI 35314	262931	SF13- 1/4"- 1M Chisel Point (15-30 Sheets)	Heavy-Duty Staplers	1/2"	1/4"	1000	
Swingline	SWI 35318	262949	SF13- 3/8"- 1M Chisel Point (25-60 Sheets)	Heavy-Duty Staplers	1/2"	3/8"	1000	
Swingline	SWI 35312	261057	SF13- 1/2"- 1M Chisel Point (40-90 Sheets)	Heavy-Duty Staplers	1/2"	1/2"	1000	
Swingline	SWI 35550	481903	Optima High Cap ty Staples	77701, 87870, 48210 Staplers	1/2"	3/8"	2500	
Swingline	SWI 90009	700856	Light Touch Heavy-Duty Staples	Heavy-Duty Staplers 90010	1/2"	5/8"	2500	
Swingline	SWI S7050051	232140	Stapler Cartridge for 5025e (2-BX)	5025e Superior Cartridge Electric Stapler,	1/2"	5/32"	3000	
Swingline	SWI 35665	300582	Crown Staples 1/4" (2-20 sheets)	Swingline S-8, Bostitch B-8	1/2"	1/4"	5000	
Bostitch	BOS TRA708T	551051	Refill Staples, 1/2" HD	Bostitch PHT150C, TR150, TR250, TRE550, TR150HL, Arrow T50, T50PBN, ETF50, T55, HT50, Powershot 5700	-	1/2"	1000	
Bostitch	BOS SBS1914CP	327106	Standard Chisel	All Standard Staplers	1/2"	1/4"	5000	
Bostitch	BOS STCRP2115	9381	B8® PowerCrown™ Staples, Chisel Pt., 2-30 Sheets	B8RC Line, B8HDP, B8E-VALUE	1/2"	1/4"	5000	
Bostitch	BOS STCR211538	474106	B8® PowerCrown™ Staples, Chisel Pt., 30-45 Sheets	B8HDP, B8E-VALUE	1/2"	3/8"	5000	
Bostitch	BOS STCR130XHC	1032648	EZ Squeeze™ B8® PowerCrown™ Staples	B8130 EZ Squeeze™	1/2"	13/16"	1000	
Bostitch	BOS SP191-4	9373	Chisel Point	P3 Plier	5/16"	1/4"	5000	
Bostitch	BOS SB353/8-1M	300269	3/8 Heavy-Duty Staples (25-55 sheets)	B310HDS, 03201, 00540	1/2"	3/8"	1000	
Bostitch	BOS SB351/4-5M	1072362	1/4 Heavy-Duty Staples (2-25 sheets)	All Bostitch Heavy Duty Staplers	1/2"	1/4"	5000	
Bostitch	BOS SB353/8-5M	1032606	3/8 Heavy-Duty Staples (25-55 sheets)	All Bostitch Heavy Duty Staplers	1/2"	3/8"	5000	
Bostitch	BOS SB351/2-1M	300277	1/2 Heavy-Duty Staples (55-85 sheets)	B310HDS, 00540	1/2"	1/2"	1000	
Bostitch	BOS SB351/4-1M	300251	1/4 Heavy-Duty Staples (2-25 sheets)	B310HDS, 03201, 00540	1/2"	1/4"	1000	
Bostitch	BOS SB355/8-1M	300186	5/8 Heavy-Duty Staples (85-130 sheets)	B310HDS, 00540	1/2"	5/8"	1000	
Bostitch	BOS SB351316HC	546838	13/16 Heavy-Duty Staples (130-165 sheets)	00540	1/2"	13/16"	1000	
Bostitch	BOS SB351516HC	546820	15/16 Heavy-Duty Staples (165-215 sheets)	00540	1/2"	15/16"	1000	
Arrow	ARR 50424SP	136184	1/4" Heavy-duty Staples	Arrow T50	1/2"	1/4"	1250	
Arrow	ARR 50524SP	136192	5/16" Heavy-Duty Staples	Arrow T51	1/2"	5/16"	1250	
Arrow	ARR 50624SP	136200	3/8" Heavy-Duty Staples	Arrow T52	1/2"	3/8"	1250	
Arrow	ARR 50824SP	136218	1/2" heavy-Duty staples	Arrow T53	1/2"	1/2"	1250	
Arrow	ARR 225	3780	Refill Staples 5/16"	Arrow P22	1/2"	5/16"	5000	
Arrow	ARR 224	211441	Refill Staples 1/4"	Arrow P22	1/2"	1/4"	5000	



## A 2-3-Hole Electric Paper Punch

Punches 2 or 3 holes (9/32") and up to 24 sheets. Manual switch for paper jams. See-through fill window.

**SWI 03109** (738385)

## B Optima® 20 3-Hole Electric Paper Punch

Punches 3 holes of 1/4" and up to 20 sheets. Alignment indication. Transparent, hinged chip door. Oversized activation button. Auto-reverse. Works on AC or with 6 AA batteries (not included). Limited 2-year warranty.

**SWI 74520** (113530)

## C Electric 3-Hole Punch

Sleek and compact. Capacity of 12 sheets. Standard 9/32 in. 3-hole configuration. Adjustable paper guide. Uses 6 AA batteries (not included). 13-3/16 W x 3-1/2 D x 3-5/16 H in. Black.

**BOS EHP3BLK** (527531)

## D M-450 2 to 7-Hole Heavy-Duty Paper Punch

Punches 2 to 7 holes of 9/32" diameter and up to 40 sheets (letter or legal). Adjustable paper guide. Non-skid base. 4 punch heads included. Limited lifetime warranty.

**SWI 74452** (190)

- 9/32" punch head
- SWI 74854** (210344)

## E Apsco 330A 3-Hole Heavy-Duty Paper Punch

Punches 3 holes and up to 30 sheets. 1/4" punch heads.

**SAN 6253836000** (211136)

## F M110 3-Hole Heavy-Duty Paper Punch

Punches 3 holes of 9/32" diameter and up to 30 sheets.

**SWI 74110** (404020)

## G M-350 2 to 7-Hole Heavy-Duty Paper Punch

Punches 2 to 7 holes of 9/32" diameter and up to 32 sheets. Adjustable. 3 punch heads included.

**SWI 74350** (415539)

- Punch head

**SWI74866** (136754) 9/32"

**SWI74868** (1032036) 13/32"



**A** *Swingline*



**B** *Swingline*



**C** **BOSTITCH**



**D** *Swingline*



**E** **Apsco**



**F** *Swingline*



**G** *Swingline*



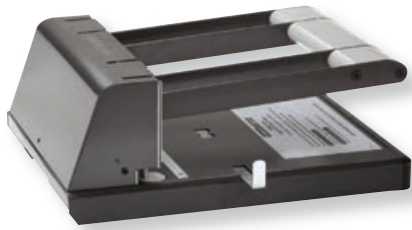

**A** **BOSTITCH**



**B** *Swingline*



**A Xtreme Duty Adjustable Paper Punch**

Punches up to 160 sheets with minimal effort. Punches 9/32" holes, in either standard 2-hole or 3-hole configurations. Antibacterial protection. Metal construction. Black.  
**BOS 03200** (560615)

**B Light Touch® 2 to 7-Hole Heavy-Duty Paper Punch**

Punches 2 to 7 holes and up to 40 sheets. Vertical feed and effortless operation. 3 punch heads included. Limited lifetime warranty.  
**SWI 74357** (655134)  
 • 9/32" punch head  
**SWI 5050574873** (136788)

**C Protec 3-Hole Paper Punch**

Punches 3 holes of 9/32" diameter and up to 30 sheets. Fixed paper centering guide. Limited lifetime warranty.  
**SWI 16453** (720359)

**D 3-Hole Heavy-Duty Paper Punch**

Punches up to 40 sheets, 9/32" holes. Adjustable hole positions. Soft pad grip. Black.  
**BSN 62897** (1031871)

**E Heavy-Duty 3-Hole Punch**

Punches up to 30 sheets, 9/32" holes. Black.  
**BSN 65625** (1032069)

**F Heavy-Duty 3-Hole Punch**

Punches 3 holes up to 100 sheets of 9/32" holes. Metal construction. Black.  
**BSN06527** (1032119)

**G SmartTouch® 3-Hole Low Force Paper Punch**

Punches 9/32" diameter holes. Lever locks down for space saving. Punch up to 45 sheets. Limited lifetime warranty.  
**SWI 19235** (538488)



**C** *Swingline*



**D** **B** BUSINESS SOURCE®



**E** **B** BUSINESS SOURCE®



**F** **B** BUSINESS SOURCE®



**G** *Swingline*



## A SmartTouch® 3-Hole Low Force Paper Punch

Punches 9/32" diameter holes. Lever locks down for space saving. Punches up to 20 pages. Limited lifetime warranty.  
**SWI 74133** (195305)



## B Light Touch® 2 Or 3-Hole Lever Professional Paper Punch

Punches 2 or 3 holes of 9/32" diameter and up to 12 sheets. Soft-touch lever. Adjustable.  
**SWI 74026** (324012)  
 • 9/32" punch head  
**SWI 5050574870** (136770)

## C Light Touch® 2 to 7-Hole Paper Punch

With lever handle. High capacity. Punches from 2 to 7 holes of 9/32" diameter and up to 20 sheets. Soft-touch lever. Built-in paper guide. Limited lifetime warranty.  
**SWI 74030** (482018)  
 • 9/32" punch head  
**SWI 74865** (739847)

**A** *Swingline*



**B** *Swingline*



## D Precision Pro® 2 Or 3-Hole Paper Punch

Punches 2 or 3 holes of 9/32" diameter and up to 10 sheets. Semi-adjustable punch heads for flexible punching.  
**SWI 74037** (536300)



## E Office Konnect 3-Hole Punch

Durable metal construction. Rubber base. Punch up to 12 sheets. White. Lifetime Warranty.  
**BOS829437** (829437)

## F M-12 2 Or 3-Hole Economy Paper Punch

Punches 2 or 3 holes of 9/32" diameter and up to 8 sheets. Adjustable.  
**SWI 74003** (258897)

**C** *Swingline*



**D** *Swingline*



## G Offix® TP301-NP 3-Hole Paper Punch

Punches 3 holes, 9/32". 12-sheet capacity. Metal.  
**NVX 344515** (344515)

## H M20 2 Or 3-Hole Paper Punch

Punches 2 or 3 holes of 9/32" diameter and up to 11 sheets. Adjustable. Limited lifetime warranty.  
**SWI 74020** (210252)  
 • 9/32" punch head  
**SWI 74850** (146662)



## I KleenEarth 3-Hole Punch

Features a compact construction to store easily in three-ring binders. Doubles as a 10 in. ruler. Black. 70% recycled content, 30% post-consumer.  
**ACM 05834** (521542)



**E** **BOSTITCH**



**F** *Swingline*



**G** **offix**



**H** *Swingline*



**I** **WESTCOTT**  
 Depuis 1872 Since 1872





**A**



**B**

*Swingline*



**A Two-Hole Metal Punch**

Punches up to 60 sheets, 1/4 in. holes. 2-tone metal design with rubber base protects work surface. Blue/silver.  
**BSN 62896** (1031856)

**B SmartTouch® 2-Hole Low Force Paper Punch**

Punches two 9/32" diameter holes and 20 sheets. Lever locks down for space saving. Limited lifetime warranty.  
**SWI 74135** (235929)

**C 10X 2-Hole Paper Punch**

Punches 2 holes of 1/4" diameter and up to 28 sheets.  
**SWI 74101** (210260)



**C**

*Swingline*



**D**

*Swingline*



**D 5X 2-Hole Economical Paper Punch**

Punches 2 holes of 1/4" diameter and up to 24 sheets.  
**SWI74105** (258707)

**E Easy-View™ 2-Hole Paper Punch**

Punches 2 holes of 9/32" diameter and up to 20 sheets. Alignment indicator. Adjustable paper guide.  
**SWI 74055** (722645)

**F Offix® 2- Hole Paper Punch**

Punches 2 holes, 1/4". 24-sheet capacity. Metal.  
**NVX 344507** (344507)



**E**

*Swingline*



**F**

**offix**



**G Slot Punch**

Punches one 5/32" hole and up to 5 sheets. Metal construction.  
**BSN 39282** (1032085)

**H PaperPro InLight ACI2402 Manual 1-Hole Punch**

EZ Squeeze technology by PaperPro requires 50% less force. Punches up to 10 sheets. No-Jam technology. Ergonomic design and comfortable grip. Easy-clean chip tray. 1/4" hole. Limited 3 year warranty.  
**ACI 2402** (828121)

**I Classic 1-Hole Punch**

All-metal construction. 5-sheet capacity (20 lb. paper). 1/4" hole. Paper chip holder. Built-in ring for storage. 5 x 1/2". Chrome.  
**SWI 74005** (538470)



**G**



**H**

**BOSTITCH**



**J Round Hole Punch With Metal Receptacle**

Durable metal construction. Easy to use and small enough to fit in a briefcase or book bag. Comfortable handle. Punches one 1/8" hole and up to 5 sheets.  
**ACM 00588** (301408)



**I**

*Swingline*



**J**

**WESTCOTT**  
*Depuis 1872 Since 1872*



## A Steel Ruler With Cork Backing

Assorted colours.

ACM 50206 (723494) 15 cm metric/6"

ACM 50205 (723502) 30 cm metric/12"

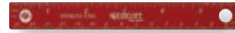

## B Steel Ruler With Cork Backing

ACM 50200 (210484) 15 cm metric/6"

ACM 50201 (210450) 30 cm metric/12"

ACM 50202 (216) 38 cm metric/15"

ACM 50203 (210468) 45 cm metric/18"

ACM 50204 (210476) 60 cm metric/24"



## C Steel Ruler With Cork Backing

STD 96353-18BK (513895) 450 mm metric/18"

STD 96353-12BK (514992) 300 mm metric/12"



## D Transparent Acrylic Ruler

Metric and imperial scales.

ACM 11244 (317370) 15 cm metric/6"

ACM 20020 (210419) 30 cm metric/12"

ACM 20021 (210427) 40 cm metric/16"



## E Flexible Transparent Ruler

ACM 40806 (122440) 15 cm metric/6"

ACM 40830 (25684) 30 cm metric

ACM 40812 (122432) 30 cm metric/12"



## F Transparent Rigid Plastic Ruler

Transparent. Double bevel. Metric and imperial scales.

ACM 41506 (208) 15 cm metric/6"

ACM 45012 (37986) 300 mm metric/12"



## G Plastic Ruler

Beveled edges. Punched for insertion in 3-ring binders.

30 cm metric/12". White.

BSN 32365 (1031749)



## H Wooden Ruler

Lacquered finish. Imperial scale on one side and metric scale on the other side. Metal edge on one side. 30 cm metric/12".

ACM 50185 (2097)



## I Wooden Ruler

Metric. 30 cm

ACM 16930 (426213)



## J Yard/Metre Stick

39 in. long. Solid wood. Imperial and metric scales.

ACM 50211 (266395) no metal ends

ACM 00108 (1031806) metal ends



## K Plastic Ruler

Punched for insertion in 3-ring binders. 30 cm metric/12".

SPR 01488 (1031780)



## L Recycled Plastic Ruler

Antimicrobial protection. 30 cm metric/12". Black/brown.

70% recycled content, 30% post consumer.

ACM 14077 (148908)



## M Data Ruler

Metric and imperial scales. 38 cm metric/15".

ACM 11183 (317404)



Find Magnifying Rulers on [page 551](#)



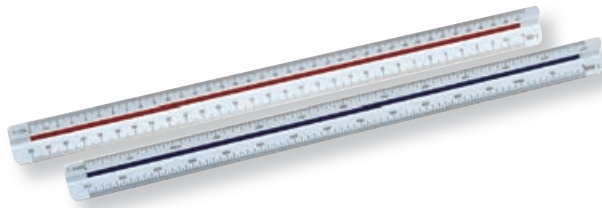

**A** 

**A Triangular Reduction Scale**

For architects, engineers, students.  
**1 1:5, 1:10, 1:20, 1:50, 1:75, 1:100, 1:125**  
**STD 987-18-1BK** (307900) 30 cm metric  
**1:100, 1:200, 1:250, 1:300, 1:400, 1:500**  
**STD 987-18-4BK** (318949) 30 cm metric  
**3/32, 1/8, 3/16, 1/4, 3/8, 1/2, 3/4, 1-1/2, 3, 16**  
**STD 98718-31BK** (318923) 12"  
**10, 20, 30, 40, 50, 60: inch**  
**STD 98718-34BK** (318931) 12"



**B** 

**B Mars® Protractor**

Double inverse graduation with 1/2° increments. Beveled edge. 6 in. 180°.  
**STD 568-52-15** (195222)



**C** 

**C Protractor**

10° increments. 4". Transparent.  
**STD 568-50-10** (228098)

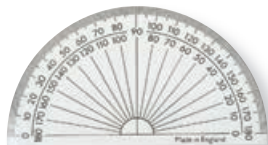

**D** 

**D 180° Acrylic Protractor**

1 - 5 - 10° increments. 4". Transparent.  
**ACM 00094** (673913)



**E** 

**E Triangle**

Made of durable plastic. Easy to use. Sold by each.  
**ACM 00460** (317776) 30-60°/100 mm  
**ACM 00445** (317768) 45°/80 mm



**F** 

**F 10-Pc Geometry Set**

Includes a metal divider, metal compass with universal adapter, mini eraser, woodless pencil, 6" protractor, 6" ruler, 2 triangles and a sharpener. Plastic case.  
**STD 55060S3A6** (267625)



**G** 

**G Xcellence 10-Piece Geometry Set**

Includes a 6" ruler, 2 triangles, 1 protractor, 1 lettering guide, 4" compass, 4" divider, a wooden pencil, a sharpener and an eraser. Metal case.  
**STD 557-10-BN** (544494)



**H** 

**H Comfort Mars® 556 6 in. Compass**

Sturdy plastic and metal. Interchangeable needle. Maximum circle of approximately 225mm. Length 154mm. With center wheel, pouch and box of leads. Sold by each.  
**STD 556-00WP** (347377) blue  
 • Package of 3 tubes of 4 HB leads  
**STD556-P12** (319103)



**I** 

**I Stop System Innovation Geometry Set**

Guarantees drawing without slipping thanks to the intuitive system of blocking arms. 8-pieces. Assorted colours.  
**MAP 196649** (809582)



**J** 

**J Oxford Helix® Geometry Set**

10-piece. Metal case.  
**MAP Z38XH0** (218115)



**K** 

**K Mars® Erasing Shield**

Made of flexible stainless steel with a matte finish and various apertures. It is a valuable aid in precision erasure of particular sections, lines, dots, curves, etc. while protecting the rest of the drawing.  
**STD 529-50BK** (353391)



## A Magnifying Ruler

Centre section isolates and magnifies one line at a time.  
38 cm metric /15 in.  
ACM 40711 (372318)



**A** WESTCOTT  
Depuis 1872 Since 1872

## B Magnifier Ruler

1-1/2 x 9-1/2 in. 1.5X magnification with a 3X section.  
MAP395110 (554725)

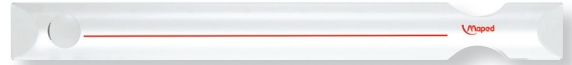

**B** Maped

## C Magnifying Ruler

12 in. length. Features 2x magnification for proofing text in the raised clear middle. Imperial and metric scales.  
ACM 15571 (1031772)



**C** WESTCOTT  
Depuis 1872 Since 1872

## D Lighted Magnifying Glass

Rectangular shape. Requires 2 AAA batteries (not included).  
6x magnification on one section and x2 on the other.  
Adjustable ergonomic handle. Lens size: 8.9cm x 5.7cm.  
MAP395211 (525386)

## E Ergologic Magnifying Glass

Ergonomic handle. 3X magnification. 3 in. diameter.  
MAP039300 (539197)

## F Card Magnifying Glass

Credit card size (2 x 3-1/2 in.), with protective carrying case.  
MGELG838PG (611939)  
Sheet magnifier, 7 x 10 in.  
MGELG828PG (611921)

## G Round Magnifying Glass

3 in. Perfect for small prints. 3X magnification.  
MGELG-675BL (734434)

## H Illuminated Magnifier

The combination of light and magnification provides a bright viewing area and eases eyestrain. Requires two AA batteries (not included).  
2X main magnification and a 4X bifocal inset. 3 in. H.  
SPR01878 (1032796)



**D** Maped



**E** Maped



**F** MERANGUE



**G** MERANGUE



**H** Sparco



**A** **WESTCOTT**  
Depuis 1872 Since 1872



**A Titanium Bonded® TrimAir Guillotine Trimmer**

Ideal for home, office, school and craft use. Titanium Bonded® curved cutting blade is 3 times stronger than stainless steel and stays sharper longer. Handle contains an antimicrobial agent to inhibit the growth of bacterial stains and odours. Safety built in with protective rail guard, front finger rest and blade latch hook. Wood base. Cutting capacity of up to 30 sheets of paper. 15-year warranty.

**ACM 15106** (135111) 12 in. (30 cm)

**ACM 15099** (135137) 15 in. (38 cm)

**ACM 15108** (135145) 18 in. (46 cm)

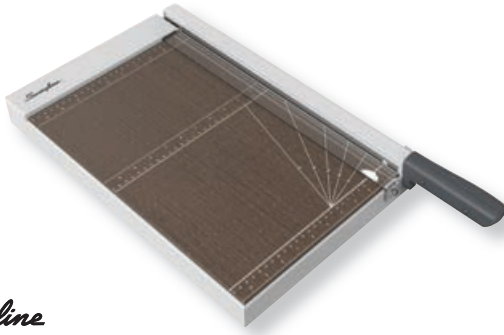

**B** *Swingline*



**B ClassicCut® Paper Trimmer With LED illumination**

Cuts up to 10 sheets. 15 inch cutting length. Solid wood surface. With EdgeGlow LED illumination to align papers. Requires 3 AAA batteries (included).

**GBC 67010002** (804534)

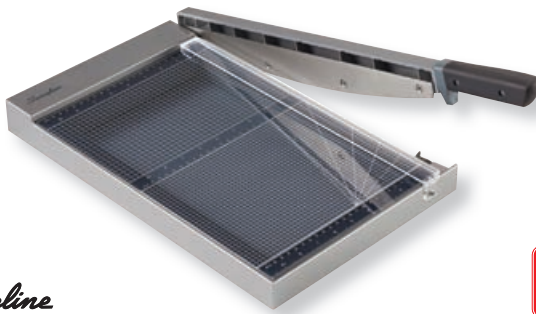

**C** *Swingline*



**C ClassicCut® Glass Guillotine Trimmer With EdgeGlow™**

With EdgeGlow LED illumination. Simply lift the blade and line your paper up with the light guide for clear and accurate trimming. Tempered glass surface printed with alignment guides. Safety latch secures blade when not in use. Requires 3 AAA batteries (included). Limited 5-year warranty.

**SWI 67010005** (827878) 12 in (30 sheets)

**SWI 67010004** (827877) 15 in. (15 sheets)



**D** **X-ACTO™**



**D Heavy-Duty Wood Paper Trimmers**

Cutting capacity of up to 15 sheets. Durable wood base with rubber feet. Safety guard. 15 in. Limited two-year warranty.

**EPI 26315T** (1031608)



**E** **X-ACTO™**



**E Heavy-Duty Paper Trimmer**

Cutting capacity of up to 15 sheets. 12 in. cutting edge. Heavy-duty plastic base with rubber feet. Ergonomically designed detachable pistol grip handle. 13 x 13 in. Limited two-year warranty.

**EPI 26232T** (1031707)



**F** *Swingline*



**F ClassicCut Fixed Blade 8 Trimmer**

Cuts up to 8 sheets. 12 inch cutting length. Durable plastic base. Straight, double-bevel blade.

**GBC 67010007** (804542)

## A ClassicCut® Bypass 10 Rotary Trimmer

Concealed blade. Sturdy metal base. Features an alignment grid, dual scale ruler and transparent cutting guide. 10-sheet capacity.

**GBC 67010008** (804567)

- Package of 2 replacement blades  
**SWI 833326** (833326)



**A** *Swingline*



## B ClassicCut 15 MultiCut Rotary Trimmer

Concealed blade. Sturdy metal base. Features an alignment grid, dual scale ruler and transparent cutting guide. Soft grip handle. Includes straight, perf and wave cutting blades. 15-sheet capacity.

**GBC 67010009** (804575)

- Package of 2 replacement blades  
**SWI 828122** (828122)
- Package of 2 replacement cutting mats  
**SWI 828123** (828123)

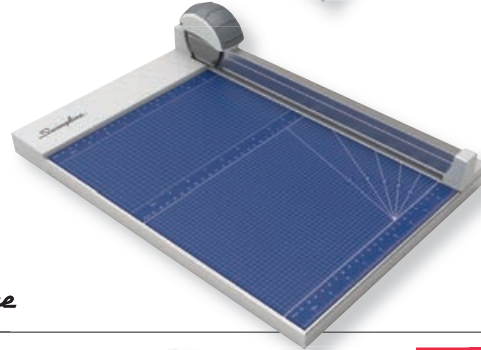

**B** *Swingline*



## C Carbo Titanium Antimicrobial Personal Paper Trimmer

Plastic components contain an antimicrobial agent. Comfort grip blade carriage with spring assist. Easy-to-read measuring grid. Swing-out ruler extends the measuring deck to 14-1/2 in. Cuts up to 10 sheets. 12 in. Green and white.

**ACM 13782** (827986)

- Package of 2 replacement blades  
**ACM 16854** (832998)



**B** *Swingline*

Antimicrobial protection



## D Personal Razor Paper Trimmer

Cutting capacity of up to 3 sheets. 12 in. cutting edge. Transparent cutting guide. Quick and easy accurate trimming. Lightweight for easy storage or to take on the go.

**EPI 26402** (1031731)

## E SK-4 Self-Retracting Safety Knife

With slip-resistant handle and stainless steel channel that tightly secures the blade. Fits SKB-2, RSKB, HOB blades. Cutting depth : 3/4".

**OLF 9048** (281725)

- Replacement blades  
**OLF 9613** (296152) pkg 10

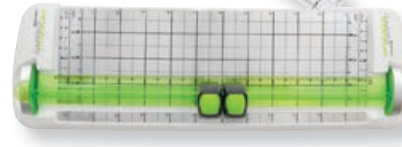

**C** **WESTCOTT**  
*Depuis 1872 Since 1872*

**N**  
2023



## F SK-10 Pro Safety Knife

Concealed blade.

**OLF 1096854** (559161)

- Replacement blades  
**OLF 1096855** (567628) pkg 10

## G Offix® Safety Knife

Self-retracting blade. Blade snaps back when friction is lost.

**NVX 585323** (585323)

- Replacement blades  
**OLF 9615** (579193) pkg 10



**D** **X-ACTO**



**E** **OLFA**



**F** **OLFA**



**G** **offix**



 <p><b>A</b> </p>	 <p><b>B</b> </p>	<p><b>A Snap Blade Utility Knife</b> Features high quality steel blades. Blade locking mechanism. Includes 1.9mm, 13 count snap blade. Lifetime warranty. <b>ACM 18031</b> (230284) • <b>Replacement blades</b> <b>ACM 18036</b> (230300) pkg 10</p> <p><b>B 180 Knife</b> Metal handle. Snap-off blades. <b>OLF 5001</b> (209379) • <b>AB replacement blades</b> <b>OLF 5010</b> (209387) pkg 10 <b>OLF 5015</b> (391425) pkg 50</p>
 <p><b>C</b> </p>	 <p><b>D</b> </p>	<p><b>C A-1 Craft Knife</b> Cuts through packaging, shrink wrap, vinyl, window film, wallpaper, caulking, foam board and other materials. <b>OLF 5023</b> (537357) • <b>AB replacement blades</b> <b>OLF 5010</b> (209387) pkg 10 • <b>ABB-10B replacement blades</b> <b>OLF 9148</b> (537365) pkg 10</p> <p><b>D Auto Lock Cutter</b> Utility knife features a rubber grip. Handle resistant to acetone to prevent early deterioration. Auto-lock mechanism keeps the blade securely in place. <b>OLF 5022</b> (1030733) • <b>ABB-10B replacement blades</b> <b>OLF 9148</b> (537365) pkg 10 • <b>AB replacement blades</b> <b>OLF 5010</b> (209387) pkg 10 <b>OLF 5015</b> (391425) pkg 50</p>
 <p><b>E</b> </p>	 <p><b>F</b> </p>	<p><b>E SVR-2 Utility Knife</b> Corrosion- and chemical-resistant. Ultra-slim for maneuverability. Auto-lock blade actuator. Pocket clip and blade snapper. No tool blade change. Pre-loaded with a 9mm precision stainless steel snap-off blade. <b>OLF 5019</b> (532010)</p>
 <p><b>G</b> </p>	 <p><b>H</b> </p>	<p><b>F Heavy-Duty L-1 Knife</b> With tightening screw to adjust blade. <b>OLF 5003</b> (209353) • <b>LB replacement blades</b> <b>OLF 5009</b> (40469) pkg 10 <b>OLF 5016</b> (391391) pkg 50</p> <p><b>G XA-1 Utility Knife</b> Non-slip handle. For leather, rubber, cardboard, rope, acetates and paper. <b>OLF 1075449</b> (543777) <b>ABB-10B replacement blades</b> <b>OLF 9148</b> (537365) pkg 10 • <b>LB replacement blades</b> <b>OLF 5009</b> (40469) pkg 10 • <b>AB replacement blades</b> <b>OLF 5010</b> (209387) pkg 10 <b>OLF 5015</b> (391425) pkg 50</p>
 <p><b>I</b> </p>	 <p><b>J</b> </p>	<p><b>H Utility Knife</b> Metal. Retractable blade. 5-blade slide. Blade storage in the handle. 3 blades included. Grey. <b>BOS 10-099</b> (770008) • <b>Replacement blades</b> <b>BOS 11-921</b> (770016) pkg 5</p>
 <p><b>K</b> </p>	<p><b>K Tap-Action Razor Knife</b> Preset blade exposure prevents merchandise damage. Tap and blade appears. Box of 12. <b>SPR 01484</b> (1030858) • <b>Replacement blades</b> <b>SPR 01485</b> (1030766) pkg 5</p>	<p><b>I Retractable 3-Position Utility Knife</b> Retractable 6 in. blade knife with 3 positions; full, half and one-quarter cut. Includes 3 heavy-duty stainless steel blades. Knife refillable with 7-1/16 in. blades. <b>SPR 01468</b> (1030881)</p> <p><b>J Snap-Off CTN-1 Cutter</b> For corrugated boxes. Snap off blades. Steel handle. <b>OLF 9985</b> (526160) • <b>Replacement blades</b> <b>OLF 9986</b> (526178) pkg 5</p>

## A Offix® 9mm Utility Knife

Heavy-duty cutter with ratchet blade locking mechanism.  
**NVX 585331** (585331)  
 • Replacement blades  
**NVX99947** (833146) pkg 10



## B Offix® 18mm Utility Knife

Heavy-duty cutter with ratchet blade locking mechanism.  
**NVX 585349** (585349)  
 • Replacement blades  
**NVX99948** (833147) pkg 10



## C Touch Knife

Small handheld pocket utility knife features a retractable stainless steel blade. May be used on paper, card stock, photos, wood veneers and more. Yellow.  
**ACM 04304** (317586)

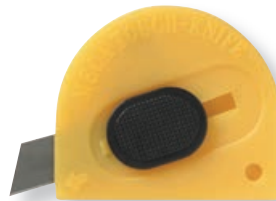

## D X-Acto® #1 Precision Knife

For delicate, precision cutting, trimming and stripping. Easily cuts paper, plastic, balsa, thin metal, cloth and acetate. Lightweight aluminum handle. With cap.  
**EPI X3601T** (336362)  
 • Replacement blades  
**EPI X211Q** (336388) pkg 5  
**EPI X411** (1030782) pkg 15  
**EPIX611** (231324) pkg 100



## E X-Acto® #1 Retrac-A-Blade™ Precision Knife

Fully retractable blade. Easily cuts paper, plastic, thin metal, cloth and acetate. Soft, comfort grip with triangle shape for extra control.  
**EPI X3204M** (292821)  
 • Replacement blades  
**EPI X211Q** (336388) pkg 10



## F Double Sided Cutting Mat

Double-sided mat with Imperial measurements on one side and Metric measurements on the other side. Made of a unique composite material, providing a non-stick, non-marring surface. Ideal for a wide variety of applications: industry, office, school or home. 5-ply construction ensures long life. Blue base with white lines for easy tracing. Blue.  
**ACM 18243** (416438) 18 x 24 in.  
**ACM 24363** (574251) 24 x 36 in.

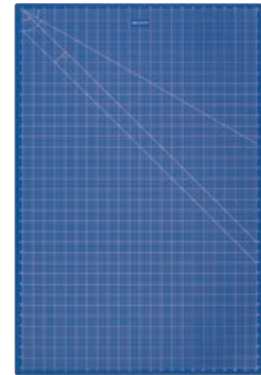

## G Pen and Knife Single Sheath

Leather. For pens, markers and cutting knife. Black.  
**BUG 378075** (378075)



## H Pen and Knife Double Sheath

Leather. For pens, markers and cutting knife. Black.  
**BUG 378083** (378083)



## I DC-4 Blade Disposal Case

Blade case with loop-hole for handy hanging.  
**OLF 1064415** (828000)



**CARBO  
 TITANIUM®**

CarboTitanium® scissors have blades 8x harder than untreated stainless steel so the blades stay sharper longer! A proprietary process creates a permanent molecular bond with the cutting surface so blades resist scratches, stains and marks! Westcott® CarboTitanium® scissors come with a lifetime warranty.



**CARBO TITANIUM®**

**8" Straight Heavy Duty Scissor**

Unique high strength ergonomic over mold handles with contoured soft grip. Reinforced high-leverage finger bows. Ideal for heavy duty cutting.

Item # 801167 (16447C)

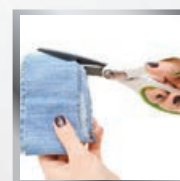

**CARBO TITANIUM® GLIDE**

**8" Straight Scissor**

New adjustable glide technology to set blade tension for optimal performance. Ergonomic comfort bows and high strength handle.

Item # 801159 (17443)

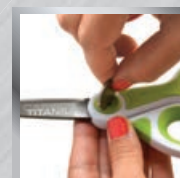

## A Pointed Lefty Scissors

Soft grip pointed lefty scissors. Red. 5 in.  
**ACM 14728** (1000439) 5" red  
**ACM 14774** (1000447) 7" blue

For left-handed users



**A** WESTCOTT  
Depuis 1872 Since 1872

## B Carbo Titanium® Ambidextrous Scissors

Suitable for heavy duty cutting of heavy fabric, boxes and plastic packages. 8 in. rounded tip. For right and left handed use. White and green handles.  
**ACM 17443** (801159)

For left or right handed users



**B** WESTCOTT  
Depuis 1872 Since 1872

## C Carbo Titanium® Bonded Scissors

Suitable for heavy duty cutting of heavy fabric, boxes and plastic packages. 8 in. rounded tip. For right handed users. White and green handles.  
**ACM 16447C** (801167)



**C** WESTCOTT  
Depuis 1872 Since 1872

## D Non Stick Titanium Bonded® Scissors

The Titanium Bonded® blades are 5 times stronger than stainless steel. Blades are highly resistant to adhesives and glue products. Less friction. Rubberized ergonomic handles. Lifetime warranty.

### Straight blades

**ACM 14851** (135715) 7"  
**ACM14849** (135426) 8"

### Bent blades

**ACM 14850** (546770) 8"

**A** WESTCOTT  
Depuis 1872 Since 1872

## E Titanium Straight Scissors

The Titanium Bonded® blades are 3 times stronger than stainless steel. Rubberized ergonomic handles. Lifetime warranty.

**ACM 13525** (691907) 5"  
**ACM 13526** (691915) 7"  
**ACM13529** (691923) 8"  
**ACM13901** (1030923) 8" (pkg 2)



**D** WESTCOTT  
Depuis 1872 Since 1872

## F ExtremEdge Titanium Bonded®

### Bent Scissors

Titanium Bonded® blades 5 times stronger than stainless steel. Adjustable tension for added control. Corrosion-resistant. 9 in. pointed tip. Lifetime warranty. Grey.

**ACM 14669** (1031202)



**E** WESTCOTT  
Depuis 1872 Since 1872



**F** WESTCOTT  
Depuis 1872 Since 1872

## G Scotch® Non-Stick Straight

### Precision Scissors

Non-stick scissors feature titanium-fused blades for more than 100,000 cuts. Ambidextrous, soft grip handles allow comfortable use by left and right-handed users. 8 in. Lifetime limited warranty. Assorted colours.

**MMM 1468TNSMXE** (1030972)



**D** WESTCOTT  
Depuis 1872 Since 1872

## H Scotch® Multi-Purposer Scissors

8" blades. Sharp, hardened stainless steel blades for smooth cutting action. Soft comfort grip handle. For both right and left handed users. Great for photos, papers and crafts. 10-year limited warranty.

**MMM1428ESF** (331785)

For left or right handed users



**G** Scotch  
www.scotch.com

## I Scotch® Precision Straight Scissors

High quality, precision sharpened 8" stainless steel blades. Best for fabric, crafts and cardstock.

**MMM 1448ESF** (230839)



**H** Scotch  
www.scotch.com



**I** Scotch  
www.scotch.com

Find kids' scissors on **pages 642 et 665**



**A** WESTCOTT  
Depuis 1872 Since 1872\*



**B** WESTCOTT  
Depuis 1872 Since 1872\*



**A Kleenearth® Soft Handle Scissors**

Stainless steel straight blades. 20% recycled plastic handles. Light and comfortable. 10 year warranty. Blue.  
**ACM 15552** (230201) 6"  
**ACM 15553** (230219) 7"  
**ACM 15554** (230227) 8"

**B Kleenearth® Soft Handle Scissors**

Stainless steel blades. Light and comfortable. 10 year warranty. Black. Plastic handles have 70% recycled content, 30% post-consumer.  
**Straight blades**  
**ACM 15587** (230250) 7"  
**ACM 15588** (1031160) 8"  
**Bent blades**  
**ACM 15589** (230268) 8"

**C KleenEarth® Hard Handle Scissors**

Stainless steel blades. 10 year warranty. Black. Plastic handles have 70% recycled content, 30% post-consumer.  
**Straight blades**  
**ACM15582** (230235) 7"  
**ACM13138** (546788) 9"  
**Bent blades**  
**ACM15584** (230243) 8"

**D Straight Scissors**

8". Stainless steel blades. Plastic handles. 5 year warranty. Black.  
**ACM 22018** (334722)

**E KleenEarth® Recycled Scissors**

Stainless steel blades. 20% recycled plastic bent handles. Light and comfortable. Antimicrobial protection. Green. 10 year warranty.  
**ACM 14835C** (131417) 5"  
**ACM 14834** (110759) 7"  
**ACM 14820** (110742) 8"

**F Antimicrobial Scissors**

To inhibit bacteria growth. Corrosion-resistant blades. Ambidextrous for use by both left and right-handed users. 8 in.  
**ACM 14609X** (550970) 7" assorted colours  
**ACM14645X** (1030998) 8" pink  
**ACM 14643X** (1030980) 8" blue

**G Super Snip Scissors**

Jagged stainless steel blades can cut leather, rubber, carpet and aluminum. Plastic handles. 5-year warranty.  
**ACM 47517** (141309)

**H Offix® Straight Scissors**

Precision ground stainless steel blades. 7" - 18 cm.  
**Straight blades**  
**NVX 575936** (575936) 5"  
**NVX575928** (575928) 7"  
**Bent blades**  
**NVX585042** (585042) 8-1/2"



**C** WESTCOTT  
Depuis 1872 Since 1872\*



**D** WESTCOTT  
Depuis 1872 Since 1872\*



**E** WESTCOTT  
Depuis 1872 Since 1872\*



**F** WESTCOTT  
Depuis 1872 Since 1872\*



**G** WESTCOTT  
Depuis 1872 Since 1872\*



**H** offix



## A Quiet Electric Sharpener

XHC cutter technology for 70% faster sharpening and 10 x longer life. Super duty motor, quiet stall-free operation. MagnaSafe tamper-proof safety switch shuts down motor when tray is removed. 6 size selector dial. High capacity shavings tray. Oversized base with suction cup feet. 7 Year Limited Warranty.

**BOS EPS10HC** (466334)



## B School Pro Electric Sharpener

Smart Stop® and Safe Start® features, prevents over-sharpening. Cutters disengage when the correct pencil point is achieved. Special cutting system provides a sharp rounded point. 6-size dial, fits nearly every pencil. Compatible with coloured pencil. Auto-reset motor shut-off prevents overheating. Large shavings receptacle. Slip resistant bottom.

**EPI 1670XT** (806133)



## C Mighty Mite® Electric Pencil Sharpener

Perfect for office use. SafeStart® receptacle prevents operation when receptacle is not in place. Pencil Saver® feature prevents over-sharpening. Coloured pencil compatible. Hardened steel blade. Adapter included. Non-slip base.

**EPI 19501XT** (806141)

## D Powerhouse® Electric Pencil Sharpener

Heavy-duty and quiet motor. Perfect for hard-to-sharpen pencils. Anti-clog cutter gear optimized for sharpening coloured pencils. SafeStart® receptacle prevents operation when receptacle is not in place. Pencil Saver® feature prevents over-sharpening. Non-slip base.

**EPI 1799XT** (806159)



## E QuietSharp® Executive Electric Pencil Sharpener

The HHC™ cutter technology sharpens 65% faster and improve cutter life up to 6 times longer. The heavy-duty QuietSharp motor is engineered for maximum power and reduced noise. Safety switch shuts motor off when the translucent, easy-to-clean shavings bin is removed. Limited 7-year warranty. Black.

**BOS EPS8HD-BLK** (1032697)



## F iPoint® Ball Battery Powered Pencil Sharpener

Battery powered compact and portable pencil sharpener. Double blade technology for faster and longer lasting cutting performance. Safety cut off when the shavings reservoir is removed. 1-year warranty. Requires 4 AA batteries not included.

**ACM 15570** (560532)



## G KS Manual Pencil Sharpener

Wall or table mounted. 8 pencil sizes. Chrome and black. Limited 2-year warranty.

**EPI 1031T** (24646)

## H MPS1 Manual Pencil Sharpener

Wall or table mounted. 8 pencil sizes. Antimicrobial protection. Black.

**BOS MPS1-BLK** (560623)



## E BOSTITCH



## D X-ACTO™



## F WESTCOTT Depuis 1872 Since 1872™



Antimicrobial protection



## G X-ACTO™



## H BOSTITCH



Antimicrobial protection



**A Screw Top Pencil Sharpener**

Aluminum. 1 hole. With shavings receptacle.  
STD 511-63 (184739)

**B KleenEarth® Antimicrobial Pencil Sharpener**

1-hole. Receptable for shavings. Product infused with antimicrobial protection to inhibit the growth of bacterial odours. Plastic components made from 20% recycled content. Assorted colours.  
ACM 11247 (530220)

**C 2-Hole Oval Pencil Sharpener**

Large plastic translucent shavings receptacle. Assorted colours.  
STD 512-300S (617969)

**D Sharpener With Shavings Receptable**

STD 511-001 (726893) 1 hole  
STD 512-001 (726901) 2 holes



**E Mars® Lumograph Pencil Sharpener**

Metal. 1-hole. Oval shaped.  
STD 511-100 (733303)

**F Plastic Pencil Sharpener**

Oval cannister with steel blade. Single hole. Assorted colours.  
ITA 42850 (1032721)

**G Round Pencil Sharpener**

Single hole. Made of plastic. Smoke.  
ITA 42851 (1032739)

**H Metal Pencil Sharpener**

Metal blade. For standard pencils.  
STD510-10A6 (809418) 1 hole  
STD510-20 (570184) 2 holes

**I Aluminum Pencil Sharpener**

Pocket sharpener with tempered steel blade. Single hole.  
ITA42852 (1032747)



## A Aluminum Key Cabinet

Hook-hanging key fobs coordinate with ID tags inside. Pre-drilled mounting holes. Includes security lock with 2 keys and key tags. Silver.

**RSI KMCS-24** (827999) 24 keys

**RSI KMCS-48** (827997) 48 keys

**RSI KMCS-72** (827996) 72 keys

• Replacement key tags - package of 20

**RSI KMTA-51** (827998)

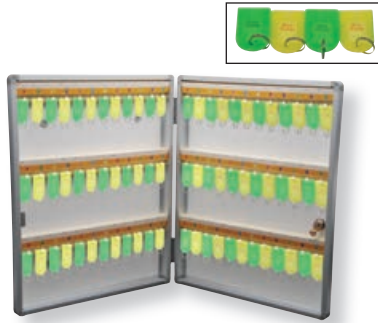

**A**

**RS** Royal Sovereign



**B**

**DURABLE**



## B Contemporary Key Cabinet

Starter set of 6 assorted key tags (2 black, 2 dark blue, 1 red and 1 yellow) and a key inventory list included. Brushed aluminum. 60% postconsumer recycled content.

**Key lock**

**DBL 1953-23** (1028760) 54 keys

**DBL 1955-23** (828033) 72 keys

**Combination lock**

**DBL 1966-23** (291146) 36 keys

**DBL 1967-23** (291153) 72 keys

• Replacement key tags - package of 6

**DBL 1957-00** (333740)



## C Key Box With Lock

Organize and secure keys. Colour-coded tags and labels make finding and returning quick and easy.

**SEN KB25** (291187) 25 keys

**SENKB50** (529586) 50 keys

## D Electronic Key Safe

Steel. Programmable battery operated key pad. Programmable 3 to 8 digit code. Side key depository slot. 48 numbered key tags coordinate with inside hooks. Includes two override keys, batteries, mounting hardware and key tags.

**RSI KMCG-48EL** (1028976)



**C**

**SentrySafe**

**D**

**RS** Royal Sovereign



## E Plastic Key Tags

For slotted rack key cabinets. Snap key hooks included. Package of 20. White.

**RSI KMTW-52** (805797)

## F Plastic Key Tags

Package of 20 in assorted colours.

**MGE 1008760100** (219709)

## G Deluxe Key Rack

Key tags are colour-coded with removable identification inserts. 8 per package.

**MGE 1008425100** (595512)

## H Plastic Key Tags

Fits most key cabinets and racks. Package of 20. White.

**MLK 7116D** (525436)



**E**

**RS** Royal Sovereign



**F**

**MERANGUE**



## I Paper Key Tags

1-1/4 in. diameter. Package of 50.

**MGE 1024301100** (595504)

## J Split Key Rings

Chrome-plated for easy key insertion and removal. 1-1/4 in. diameter. Package of 10.

**ACM 72108** (612093)

## K Wrist Coil

Plastic wrist band with split keyring. Latex free. Package of 3.

**MGE 1008303100** (352773)



**G**

**MERANGUE**

**H**

**Master Lock**



**I** **MERANGUE**



**J**

**WESTCOTT**  
Depuis 1872 Since 1872



**K**

**MERANGUE**





**A** **Master Lock**



**B** **Master Lock**

**A Solid Brass Padlock With Key**

Corrosion resistant solid brass case. Steel shackle. Come with 2 keys  
**MLK 120-D** (251322) 7/16"  
**MLK 140-D** (102640) 1-9/16"

**B 140DLH Padlock**

1-9/16" solid brass body. 2" steel shackle. Corrosion resistant. 2 keys.  
**MLK 140DLH** (525402)

**C Economy Padlock with Key**

Steel. 1-1/2". 2 keys.  
**MLK 220** (251389)

**D Key Padlock**

1-9/16" (40mm) wide laminated steel padlock with 1-1/2" (38mm) shackle. 2 keys.  
**MLK 3DLF** (574103)



**C** **Master Lock**



**D** **Master Lock**

**E Magnum Laminated Padlock**

2-1/2" boron carbide shackle for security. 1-3/4" body.  
**MLK M1BLCDLJHC** (525485)

**F Brass Padlock**

1-1/2 in (40 mm). 3 keys.  
**ACM 56144** (442756)

**G 141 Key Padlock**

Maximum security. Brass. With vinyl cover. 2 keys.  
**MLK 141D** (727800)

**H Zenex Thermoplastic Safety Padlock**

Thermoplastic is a non-conductive body that offers superior performance against chemicals, moisture, temperature and UV. Lock come with one key.  
**MLK 410-RED** (1043140)



**E** **Master Lock**



**F** **WESTCOTT**  
 Depuis 1872 Since 1872



**G** **Master Lock**



**H** **Master Lock**

**A Resettable Combination Lock**

Easy to set and reset 4-digit numeric combination. Solid body and hardened steel shackle. **MLK 175-D** (1043124)



**A** **Master Lock**

**B DYRP7 Combination Padlock**

Steel. Three digit combination. **MLK DYRP7SP** (26203)



**B** **DUDLEY**

**C 1500D Combination Padlock**

Black steel. 3-digit combination. 1-7/8". **MLK 1500-D** (251397)

**D Combination Lock**

Perfect for lockers at school or at the gym. Sturdy and durable. 1-7/8" (50 mm). **ACM 05604** (472324)

**E Antimicrobial Combination Lock**

Infused with antimicrobial protection to inhibit the growth of bacterial odours. Ideal for lockers at school or the gym. Assorted colours. **ACM 05605** (157404) 1-1/2" (40mm) **ACM 05606** (266106) 1-7/8" (50mm)

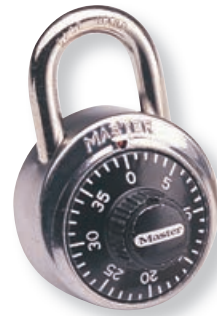

**C** **Master Lock**

**F Combination Padlock**

Combination dial padlock with aluminum cover. 1-7/8" (48mm). Assorted colours. **MLK 1530DCM** (158451)



**D** **WESTCOTT**  
Depuis 1872 Since 1872

**G Luggage Combination Padlocks**

Durable die-cast case with steel shackle. 3-digit resettable combination. Package of 2. **MLK 646T** (790279)

**H Luggage Combination Padlock**

TSA Travel Sentry Certified. Recognized in 29 countries. Allows airport security to inspect and re-lock bags. 3-digit resettable combination. Side window for combination viewing. Lifetime warranty. Black. **MLK 4680DBLK** (162198)



**E** **WESTCOTT**  
Depuis 1872 Since 1872

**I Push Button Portable Lock Box**

Four characters combination. Protective weather cover prevents freezing and jamming. Molded body and vinyl coated shackle. 3-1/8 in. W. **MLK 5422D** (525428) portable with shackle **MLK 5423D** (544197) wall mount



**F** **Master Lock**



For luggage

**G** **Master Lock**



For luggage

**H** **Master Lock**



**I** **SentrySafe**



**WORKS. PERIOD.™**  
**ÇA MARCHE. POUR VRAI.™**

For years, you have trusted LePage® and Pritt® brands for your Stationery adhesive needs. With our wide variety of products - from user-friendly Glue Sticks to Mounting Putty and White Glue - you can count on us for continued performance, innovation and reliable solutions.



**A UHU® Glue Stick**

UHU 9U-99648 (21667) 8 g  
 UHU 9U-99649 (21675) 21 g  
 UHU 9U-99655 (217331) 40 g



**A UHU**

**B Pritt® Glue Stick**

Solvent-free, acid free and PVC-free. Washable at 20°C.

PRI 442203 (178434) 11 g  
 PRI 442204 (178459) 22 g  
 PRI 442205 (178475) 42 g



**B Pritt**



**C UHU**

**C UHU® Blue Glue Stick**

Non-toxic. For paper, pictures, cardboard and fabrics. Rubs on blue, dries clear.

UHU 9U-99601 (242461) 8 g  
 UHU 9U-99602 (242479) 21 g  
 UHU 9U-99653 (289660) 40 g

**D Offix® Glue Stick**

Non-toxic. Acid-free.

NVX344549 (344549) 10 g  
 NVX344556 (344556) 20 g  
 NVX344564 (344564) 40 g



**D offix**

**E Lepage® School Glue Stick**

LEP 668409 (671479) 10 g  
 LEP 665171 (671487) 20 g  
 LEP 646239 (671495) 40 g



**E LEPAGE**



**F ELMER'S**

**F Elmer's® Glue Stick**

Washable, acid-free and non-toxic. 40 g.

EPI 60202BULK (366864)

**G Elmer's Glue Stick**

Washable. Non-toxic. Goes on purple, dries clear. 20g.

EPI 61668 (598078)

**H Pritt® Glue Roller**

Permanent. Disposable. 8.4 mm x 8.5 m.

PRI 2379351 (584441)



**G ELMER'S**

**I Glue Roller**

Disposable. 8.4 mm x 10 m.

GCI GT5058 (698712) permanent  
 GCI GT5057 (756296) removable

**J Mono Refillable Adhesive Roller**

For strong bond. Safe to use on paper, photos, cardstock and more. 8 mm x 12 m. Clear. Acid free.

**Dispenser**

TOM62106 (1032861) permanent

TOM 62108 (1032887) removable

• **Refill**

TOM 62107 (1032879) permanent

TOM 62109 (1032895) removable



**H Pritt**



**I GEO**

**K Dab N Seal® Envelope Moistener With Adhesive**

Spring-valve applicator. Dries fast. Glues more than 1,000 envelopes and other paper products.

QUA 46067 (201392) by each

QUA 46065 (203711) pkg 12

**L UHU® Stic Envelope Sealer**

Seals more than 1,000 envelopes. 21 g.

UHU 9U-99701 (671404)



**J Tombow**



**K TOPS PRODUCTS**



**L UHU**



**A** **LEPAGE**

Sold by bottle



**B** **ELMER'S**



**C** **ELMER'S**

**A Lepage® All Purpose White Glue**  
LEP 393889 (218826) 150 ml  
LEP 531252 (27284) 3 litres

**B Elmer's® Washable White Glue**  
Non-toxic.  
EPI 60307W8 (270744) 120 ml  
EPI 60310Q (426064) 225 ml  
EPI 6155060331 (573287) 950 ml  
EPI 6155060341 (426072) 3.8 litres

**C Clear School Glue**  
Safe, non-toxic, and washable. 147 ml.  
EPI 60305Q (581272)

**D Aqua Liquid Glue**  
48 ml. Clear. Acid free, odourless and washable. Will not leak or clog.  
TOM 52180 (1032903)

**E No More Nails® Latex Adhesive**  
To glue on wood, drywall, masonry, glass, ceramics, carpet, cork, PVC, moulding. 88 ml.  
LEP 2047863 (235622)

**F Rubber Cement**  
Brush on applicator. Acid-free and photo safe. 118 ml.  
EPI E64425 (347567)

**G Krazy Glue® Glue**  
Strong instant bond on rubber, plastic, metal, wood, leather and ceramic.  
EPI 6155010100 (645127) Original - 1.9 ml  
EPI 6155010582 (788141) Original - 4 x 0.5 ml  
EPI 6155010300 (1032986) Advanced -1.9 ml  
EPI 6155010330 (645143) Gel - 1.9 ml  
EPI 6155010466 (1032978) Advanced, gel - 4 ml

**H Lepage® Contact Glue**  
30 ml.  
LEP 1504637 (686188)

**I Super Glue**  
4 ml.  
LEP2598431 (804260) Ultra gel  
LEP 2600197 (804252) Control gel

**J Lepage® Adhesive Spray**  
Quick dry. Transparent on many materials. Non porous.  
Easy to reposition. 312 g.  
LEP 1726249 (226076)

**K Spray Adhesive**  
For long lasting bond on paper, plastic, foil, metal, cardboard, wood and fabric. With a wide nozzle for a no-mess application.  
EPI 60451 (524314)

**L Super 77™ Classic Spray Adhesive**  
All purpose. Bonds many foils, papers, plastics, foams, metals and cardboard. Low soak-in for long lasting periods. 467 g.  
MMM 77 (577643)



**D** **Tombow**



**E** **LEPAGE**



**F** **ELMER'S**



**G** **ELMER'S**



**H** **LEPAGE**



**I** **LEPAGE**



**J** **LEPAGE**



**K** **ELMER'S**



**L** **3M**



## A Fun-Tak® Mounting Putty

Clean and reusable. 56 g.  
LEP 1087960 (15982)

## B UHU® patafix Glue Pads

Sticks again and again. Reusable, strong and clean, non-toxic and safe.  
Package of 80.  
UHU 9U-33820 (828884)

## C UHU® tac deco™

Extra strong glue pads. Clean and removable. Package of 32.  
UHU 9U-48710 (1066943)

## D Mounting Putty

Reusable. 60 gr.  
MGE 831731 (831731)

## E No More Nails® Mounting Tape

Heavy duty, double-sided mounting tape in strips, 2 cm x 4 cm.  
Indoor & outdoor. For wood, metal, plaster, stone, concrete, ceramic.  
One strip holds up to 2 kg. Package of 10 strips.  
LEP 1873067 (433953)

## F Wall Mounting Tabs

Removable adhesive  
MMM 108-SMLESF (423202) 1/2 x 1/2" (pkg 64)  
Permanent adhesive  
MMM 111-ESF (426593) 1 x 1" (pkg 16)

## G Scotch® Reusable Mounting Tape

For lightweight mounting. Reuses again and again! Removes cleanly.  
1 x 1 in. strips. Package of 18. Clear.  
MMM R100S-ESF (265397)

## H Indoor Fasteners

Mounts household and office items up to 3 lbs. Works on most surfaces, even drywall, wood, metal or brick. 12 sets of squares, 7/8" x 7/8". White.  
MMM RF4720 (424978)

## I Extreme Fasteners

Heavy-duty UV resistant reclosable fastener. For indoor and outdoor use.  
Holds up to 10 lb. 1 x 3 in. Package of 2.  
MMM RF6731 (427401) black  
MMM RF6730 (427393) clear

## J Removable Poster Tape

Use instead of push pins. 3/4 x 150 in. Dispenser pack.  
MMM 109S-ESF (829406)

## K Wall-Safe Tape

Tape sticks securely but removes cleanly from walls and other home and office surfaces. Safe for painted drywall, stainless steel, tile wood, mirrors and windows. 3/4 x 650". Dispenser pack.  
MMM 183-ESF (435578)





**A** **VELCRO**



**B** **VELCRO**

**A Velcro® Self-Adhesive Fasteners**

Coins, 5/8". Package of 15.  
**VEK 90070C** (114181) white  
**VEK 90069C** (114173) black  
 Squares, 7/8". Package of 12.  
**VEK 90073C** (114199) white  
**VEK 90072C** (114165) black  
 Strips, 3-1/2 x 3/4". Package of 4.  
**VEK 90076C** (114215) white  
**VEK 90075C** (114207) black

**B Velcro® Industrial Adhesive Strips**

Stronger adhesive sticks to most surfaces. Water and temperature-resistant. For indoor or outdoor use.  
 Package of 2 strips, 4" x 2".  
**VEK 90200C** (114231) white  
**VEK 90199C** (114223) black  
 Tape, 10' x 2".  
**VEK 90944C** (139683) white  
**VEK90943C** (139667) black



**C** **VELCRO**



**D** **VELCRO**

**C Velcro® Self-Adhesive Strips**

Strips of hooks and loops. For smooth surfaces.  
 3/4 x 18"  
**VEK 90079C** (164244) white  
**VEK 90078C** (164236) black  
 3/4" x 5'  
**VEK 90678C** (197137) white  
**VEK 90677C** (197145) black

**D Velcro® Self-Adhesive Strips**

Roll. Not recommended for sewing purposes. 1" x 75'.  
**Loops**  
**VEK 190959** (163519) white  
**VEK 190984** (164251) black  
**Hooks**  
**VEK 191033** (163477) white  
**VEK 191051** (164269) black



**E** **VELCRO**



**F** **Scotch**

**E Velcro® Self-Adhesive Tape**

Made of hooks and loops. For smooth surfaces. 3/4" x 15'.  
**VEK 90082C** (395947) white  
**VEK 90081C** (395954) black  
**VEK 91325C** (235630) clear

**F Bundling Straps**

Self-fastening, adjustable and reusable. 1/2 x 8 in. Package of 6. Black.  
**MMM RF3710C** (513911)



**G** **Scotch**



**H** **Scotch**

**G Mount™ Clear Mounting Tape**

Strong double sided foam tape. Use on clean, dry and smooth surfaces. Indoor use.  
**MMM 110S-ESF** (829130) white - 1/2 x 75"  
**MMM 110H-DC-EF** (828096) white - 1/2 x 80"  
**MMM 214H-DC-EF** (827676) white - 1 x 55"  
**MMM 410H-DC-EF** (823867) clear - 1 x 60"

**H Mount™ Extreme Mounting Tape**

Intended for indoor and outdoor use. Ensure your surface is smooth, clean, and dry for the best bond. Can hold up to 30 pounds.  
 1 x 60 in. Black.  
**MMM 414H-DC-EF** (827893)



**I** **Scotch**



**J** **LEPAGE**

**I Double Sided Foam Tape**

Permanent adhesive. High-temperature resistant. Conforms to many textured surfaces. 12 mm x 33 m.  
**MMM 4026-12M33** (1033208)

**J No More Nails® Mounting Tape**

Super strong double sided mounting tape. Holds up to 11 lb per 15 cm. Adheres to wood, metal, glass, concrete, ceramics and many plastics. Suitable for extreme temperatures. 19 mm x 1.5 m.  
**LEP 2125574** (142968)

## A Plastic Adhesive Hooks

Small - holds up to 1 lb  
 MMM 17002C (164277) white (pkg 2)  
 MMM 17092CLR-C (209635) clear (pkg 2)  
 Medium - holds up to 3 lb  
 MMM 17001C (480442) white (pkg 2)  
 MMM 17091CLR-C (209585) clear (pkg 2)  
 MMM 17001C-VP (535963) white (pkg 6)  
 MMM 17091CLRVP (209627) clear (pkg 6)  
 Large - holds up to 5 lb  
 MMM 17003C (173120) white (pkg 1)  
 MMM 17003C-VP (520999) white (pkg 3)  
 X-large - hold up to 10 lb  
 MMM 17010-2EF (831363) white (pkg 2)  
 2X-large - hold up to 15 lb  
 MMM 17011-2EF (831362) white (pkg 2)  
 • Package of 10 assorted adhesive strips  
 MMM 17200C (559476)



## B Decorative Metal Hook

Brushed nickel. Holds 5 lb.  
 MMMR03-BN-EF (164319) square hook  
 MMM FC13-BN-C (775445) tear drop hook  
 MMM 17053BNC (596775) round hook  
 MMM17063BN-C (559468) timeless



## C Sawtooth Picture Hanger

Holds up to 5 lb. White.  
 MMM 17040C (188342)

## D Self-Adhesive Picture Hanging Strips

Holds up to 9 lb  
 MMM 17201C (697722) white (pkg 3)  
 Holds up to 12 lb  
 MMM 17204-12EF (573717) white (pkg 12)  
 MMM 17201BLK-C (596783) black (pkg 4)  
 Holds up to 16 lb  
 MMM 17206C (188375) white (pkg 4)  
 MMM17206BLK-C (533968) black (pkg 4)  
 MMM 1720612EF (598102) white (pkg 12)



## E Utensil Hooks

Holds up to 0.5 lb.  
 MMM 17067CLR-C (209460) clear (pkg 3)  
 MMM17067C (178905) white (pkg 3)  
 MMM 209577 (209577) clear (pkg 9)  
 MMM 209429 (209429) clear (pkg 18)

## F Decorative Adhesive Clips

Package of 20. Clear.  
 MMM17026CLR-C (209445)

## G Clothes Hook

Holds up to 7.5 lb. White.  
 MMM 17019-EF (535989)

## H Self-Adhesive Poster Strips

Package of 12. White.  
 MMM 17024C (673129)

## I Outdoor Light Clips

Package of 16. Clear.  
 MMM 17017CLR-A (1033190)

## J Designer Hooks

Holds up to 3 lb. White.  
 MMM 17083-EF (1033240)  
 MMM 17081-EF (1033258)

## K Large Double Hook

Holds up to 4 lb. Matte black.  
 MMM 17036MBEF (1033315)



**i** Command™ products will not damage surfaces. Simply stretch to remove.



**A** **Scotch**



**B** **Scotch**

**A Scotch® Magic™ Greener Adhesive Tape**

Plant-based adhesive. 19 mm x 22.8 m. Package of 2.  
**MMM123DM-2-EF** (833038) dispenser  
**MMM 812-2P-C** (166306) refill

**B Scotch® Magic™ Adhesive Tape Dispenser**

**MMM 104NA** (538231) 12.7mm x 11.4m (box 12)  
**MMM 105NA** (401026) 19mm x 7.62m (by each)  
**MMM 810-18PP** (229484) 18mm x 33m (by each)  
**MMM 810-D3-12** (831257) 19mm x 32.5m (pkg 3)  
**MMM M8506MPESF** (596767) 19mm x 21.5m (pkg 6)  
**MMM 810-4PK-C** (737692) 18mm x 25m (pkg 4)  
**Refill**  
**MMM 810-12BXD** (4515) 12mm x 33m (by each)  
**MMM 810-18BXD** (229492) 18mm x 33m (by each)  
**MMM 810-8PKBXD** (559450) 19mm x 25m (pkg 8)



**C** **Scotch**



**D** **offix**

**C Scotch® Magic™ Adhesive Tape Box**

Tower is made from 100% recycled cardboard with 14 unwrapped rolls of invisible tapes which means less packaging and waste. 19 mm x 33 m.  
**MMM 810R1833** (792655)

**D Offix® Invisible Adhesive Tape**

19 mm x 32.9 m.  
**NVX 347872** (347872) dispenser  
**NVX347880** (347880) refill



**E** **B** BUSINESS SOURCE



**F** **Scotch**

**E Invisible Adhesive Tape**

**BSN32952** (1033050) 19mm x 32.9m (by each)  
**BSN32953** (1033067) 19mm x 25.4m (pkg 12)

**F Scotch® Transparent Adhesive Tape Dispenser**

**MMM 144ESF** (250621) 12,7 mm x 11,4 m.  
**MMM 600-18PP** (229377) 19 mm x 33 m  
**Refill**  
**MMM600-12BXD** (229385) 12 mm x 33 m  
**MMM 600-18BXD** (229393) 19 mm x 33 m



**G** **offix**



**H** **B** BUSINESS SOURCE

**G Offix® Transparent Adhesive Tape**

19 mm x 33 m.  
**NVX347799** (347799) dispenser  
**NVX347781** (347781) refill

**H Transparent Adhesive Tape**

All-purpose glossy tape refills  
**BSN32949** (1033091) 19mm x 32.9m (by each)  
**BSN 43575** (1033075) 19mm x 25.4m (pkg 12)



**I** **Scotch**



**J** **Scotch**

**I Scotch® Magic™ Removable Adhesive Tape**

19 mm x 33 m.  
**MMM 8115-18M33** (31526)

**J Scotch® Book Tape**

13.7 m.  
**MMM 845-150** (207316) 38.1 mm  
**MMM845-200** (179648) 50.8 mm  
**MMM 845-300** (207324) 76.2 mm

**A Hedgehog Tape Dispenser**

Refillable dispenser. Weighted base. White/gold.  
**MMM 833027** (833027)



**B Desktop Tape Dispenser**

Holds standard 1 in. core tapes. Weighted base.  
**MMM C18-COR-0** (828101) coral  
**MMM C18-SEA-0** (828102) ocean blue



**C Scotch® Desktop Tape Dispenser**

Sleek, curvy weighted, complements any decor. For tapes up to 19 mm x 33 m. Black.  
**MMM C60-BK** (714295) black  
**MMM C60-ST** (821439) grey



**D Scotch® Wave Desktop Dispenser**

Personalize your desk with style with this sleek and modern dispenser. Weighted base for easy tape dispensing. Holds tape up to 3/4 in wide by 1500 in. long. 1 tape 3/4 in x 350 in included. Molten ink.  
**MMM C20WAVEMI** (806448)



**E Desktop Tape Dispenser**

Contemporary space-saving design with weighted, non-slip base. Made of molded, high-impact plastic. For tapes up to 19 mm x 33 m. Adhesive tape not included. Black.  
**ACM 80038** (231233)



**F Tape Dispenser**

Contemporary space-saving design with weighted, non-slip base. Made of molded, high-impact plastic. Fits standard tape with 1 in. (25.4 mm) core up to a maximum of 1 in. (25.4 mm) wide. Refill not included. Black.  
**ACM 80015** (255596)



**G Tartan™ Tape Dispenser**

Durable with a weighted, slip-proof base for quick and easy one-handed operation. 3 in core. Holds rolls up to 24mm wide. Black.  
**MMM HB900** (800615)



**H Hand Held Tape Dispenser**

Lightweight and portable. Metal cutting blade. For tape up to 18 mm x 33 m. Tape not included.  
**ACM 80127** (625038)





**A** **Scotch**



**B** **Scotch**

**A Masking Tape**

Designed to remove cleanly and easily from previously painted surfaces. For use with latex & oil paints. Medium adhesion. Green. 55 m.

**MMM 2055PCW24** (536086) 24 mm

**MMM 2055PCW36** (570101) 36 mm

**DDC 667016** (536094) 48 mm

**B All-Purpose Masking Tape**

55 m.

**MMM 2020-18AP** (316224) 18 mm

**MMM 2020-24AP** (316232) 24 mm

**MMM 2020-36AP** (316240) 36 mm

**MMM2020-48MP** (349613) 48 mm



**C** **Scotch**



**D** **3M**



**C ScotchBlue™ Original Painter's Tape**

Delivers sharp paint lines and can be used on a variety of surfaces.

Removes cleanly for up to 14 days and does not cause surface damage, even when exposed to direct sunlight. 54.8 m.

**MMM 2090-24EC** (517052) 24 mm

**MMM 2090-36EC** (593897) 36 mm

**D Tartan™ Filament Tape**

55 m. Very resistant.

**MMM 8934-12X55** (404400) 12 mm

**MMM 8934-18X55** (404418) 18 mm

**MMM 8934-24X55** (404426) 24 mm



**E** **Scotch**



**F** **3M**



**E 897 Filament Tape**

Reinforced with fiberglass filaments. Synthetic rubber resin adhesive. Tensile strength 170 pounds per inch width. Clear.

**MMM 897-18X55** (550194) 18 mm x 50 m

**MMM 897-24X55** (550202) 24 mm x 55 m

**F Duct Tape**

Basic. Bundle patch, protect and repair. 48 mm x 50.2 m. Silver.

**MMM 1055** (546473)



**G** **3M**

**G 3900 Duct Tape**

Polycoated cloth tape with rubber adhesive. Adheres to most surfaces.

Tear by hand. For general maintenance, wrapping, patching and protection. 48 mm x 54.8 m.

**MMM 139543** (139543) yellow

**MMM 139592** (139592) black

**MMM 139550** (139550) blue

**MMM 139584** (139584) olive

**MMM 139576** (139576) red

**MMM 139568** (139568) white



**H** **3M**



**I** **Scotch**

**H 764 General Purpose Vinyl Tape**

Sticks on contact to a wide variety of surfaces. Remove cleanly.

36 yd x 2 in.

**MMM7642X36YLW** (550244) yellow

**MMM 7642X36BLU** (1033562) blue

**MMM7642X36RED** (1033570) red

**I Double-Sided Adhesive Tape**

Hassle-free alternative to glue. Both sides of tape coated with permanent adhesive. Invisible when applied. Photo-safe for colour photos.

**Permanent - 12 mm x 6.3 m**

**MMM 136NA** (473280)

**Removable - 19 mm x 10.1 m**

**MMM 667ESF** (521138)



**J** **Scotch**



**K** **Scotch**

**J Double-Sided Adhesive Tape**

With 3 in. core. 12 mm x 33 m.

**MMM 665-12M33** (229468)

**K Indoor Carpet Tape**

Permanent. 1-1/2 in x 42 ft.

**MMM CT2010** (521286)

**A Acco Metal Fasteners**

Box of 100.

Brass-plated white metal

ACC 71709 (111393) 1/2"

ACC 71703 (111385) 3/4"

ACC71710 (111401) 1"

ACC 71711 (529776) 1-1/4"

ACC 71712 (111419) 1-1/2"

ACC 71713 (111427) 2"

ACC 71714 (111435) 3"

Solid brass

ACC 71504 (164145) 1"

ACC 71506 (164152) 1-1/2"

ACC 71507 (164160) 2"

• Westcott washers

ACM 05791 (301515) #1 (3/8 - 1")

ACM 05792 (301523) #2 (1-1/4 - 4")



**B Self-Adhesive Prong Fasteners**

Width of 2-3/4". 2" capacity. Box of 100.

ACC 70021 (158)

**C Prong Fasteners**

Steel fastener base and compressor. Box of 50.

2-3/4" width

ACC 70012 (210088) cap. 1"

ACC70022 (1594) cap. 2"

ACC 70324 (1651) cap. 3-1/2"

4-1/4" width

ACC 70424 (210120) cap. 3"

8-1/2" width

ACC 70723 (210179) cap. 3"

• Base only - 2-3/4" wide (box 100)

ACC70013 (210096) cap. 1"

ACC 70023 (1602) cap. 2"

• Compressor only - 2-3/4" wide (box 100)

ACC 70014 (210104)



**D Prong Fasteners**

Width 2-3/4", capacity 2".

Base and compressor - box of 50

BSN R20 (1012103)

Base only - box of 100

BSNB21 (1012061)

Compressor only - box of 100

BSN C1 (1012079)



**Pendaflex**



**E EZ Place™ Self-Adhesive Fastener**

Mounted on board stock for proper centering and alignment.

Package of 48.

PFX99371 (734806) 1"

PFX99372 (734814) 2"



**F Self-Adhesive Fasteners**

2-3/4" wide. Box of 100.

BSNSA11 (1012087) 1"

BSNSA21 (1012095) 2"



**Pendaflex**

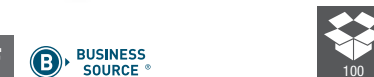

**G Nickel-Plated All-Purpose Rings**

ACM 75075 (482695) 3/4" (box 100)

ACM 75150 (182790) 1" (pkg 18)

ACM75101 (482703) 1" (box 100)

ACM 75315 (482729) 1-1/2" (bte 100)

ACM 75440 (560516) 2" (pkg 4)

ACM 75402 (482737) 2" (box 50)

ACM 75603 (482752) 3" (box 10)



**WESTCOTT**  
Depuis 1872 Since 1872



**H Nickel-Plated All-Purpose Rings**

BSN01435 (1030337) 3/4" (box 100)

BSN01436 (1030295) 1" (box 100)

BSN01438 (1030303) 1-1/2" (box 100)

BSN01439 (1030311) 2" (box 50)

BSN01441 (1030329) 3" (box 10)



**A Rubber Band Ball**

Provides approximately 275 rubber bands. 5.6 oz. 3-1/4 x 1/8". Assorted colours.  
**ACC 72155** (470484)

**B Elastic Rubber Bands**

#117B - 7 x 1/8 in. Package of 24. Assorted colours.  
**VLB 80125** (585018)

**C Big Bands™ Rubber Bands**

Large rubber bands ideal for bundling, storing and organizing. 7 x 1/8 in. Package of 12. Red.  
**VLB 00712** (596957)

**D Brites® Pic Pac Rubber Bands**

Assorted popular colours and sizes. 1.5 oz. dispenser box.  
**VLB 00706** (596965)

**E Antimicrobial Elastic Rubber Bands**

Latex free, no natural rubber proteins. Antimicrobial protection inhibits the growth of fungi, mold and bacteria that can cause early product deterioration. Bright cyan blue colour for easy identification. Box of 114 g (1/4lb).

- VLB 42189** (786129) 1/16 x 3" ..... #18
- VLB 42199** (786137) 1/16 x 3-1/2" ..... #19
- VLB 42249** (786145) 1/16 x 6" ..... #24
- VLB 42329** (786152) 1/8 x 3" ..... #32
- VLB 42339** (786178) 1/8 x 3-1/2" ..... #33
- VLB 42649** (786186) 1/4 x 3-1/2" ..... #64



**F Star® Elastic Rubber Bands**

Latex free. Box of 114 g (1/4 lb)

- DIX89004** (19844) 1/16 x 1-1/4" ..... #10
- DIX89007** (216937) 1/16 x 1-2/3" ..... #12
- DIX89010** (216986) 1/16 x 2" ..... #14
- DIX89013** (216994) 1/16 x 2-1/2" ..... #16
- DIX89016** (217000) 1/16 x 3" ..... #18
- DIX89019** (217018) 1/16 x 3-1/2" ..... #19
- DIX89022** (217026) 1/8 x 2" ..... #30
- DIX89025** (20016) 1/8 x 2-1/2" ..... #31
- DIX89028** (20024) 1/8 x 3" ..... #32
- DIX89031** (20032) 1/8 x 3-1/2" ..... #33
- DIX89034** (20073) 1/4 x 2" ..... #61
- DIX89037** (20081) 1/4 x 2-1/2" ..... #62
- DIX89043** (20107) 1/4 x 3-1/2" ..... #64
- DIX89052** (20313) 1/2 x 3-1/2" ..... #84
- DIX89055** (216929) 5/8 x 5" ..... #105
- DIX89079** (181172) 5/8 x 6" ..... #106
- DIX89058** (15271) 5/8 x 7" ..... #107
- DIX89064** (2006) 1/16 x 6" ..... #6TH
- DIX89067** (14464) assorted

Antimicrobial protection

**G Star® Elastic Rubber Bands**

Latex free. Bag of 2,27 g (5 lb).

- DIX89054** (379560) 1/16 x 2-1/2" ..... #16
- DIX89054** (379610) 1/16 x 3" ..... #18
- DIX89054** (379578) 1/16 x 3-1/2" ..... #19
- DIX89054** (392266) 1/8 x 2" ..... #30
- DIX89054** (379594) 1/8 x 3" ..... #32
- DIX89054** (379602) 1/8 x 3-1/2" ..... #33
- DIX89054** (24257) 1/4 x 3-1/2" ..... #64
- DIX89054** (1031269) 1/2 x 3-1/2" ..... #84
- DIX89054** (419622) 5/8 x 6" ..... #106
- DIX89054** (189118) 1/16 x 6" ..... #6TH





## A Offix® Elastic Rubber Bands

1/4 lb (113 g) box.

NVX344309 (344309) 1/16 x 1-1/4" .....	#10
NVX344317 (344317) 1/16 x 1-3/4" .....	#12
NVX344325 (344325) 1/16 x 2" .....	#14
NVX344333 (344333) 1/16 x 2-1/2" .....	#16
NVX344341 (344341) 1/16 x 3" .....	#18
NVX344358 (344358) 1/16 x 3-1/2" .....	#19
NVX344366 (344366) 1/8 x 3" .....	#32
NVX344374 (344374) 1/8 x 3-1/2" .....	#33
NVX344408 (344408) 1/4 x 3-1/2" .....	#64
NVX344390 (344390) 1/16 x 5" .....	#5 Th
NVX344416 (344416) 1/16 x 6" .....	#6 Th
NVX344671 (344671) 5/8 x 6" .....	#106
NVX344382 (344382) assorted, .....	#333



## B Offix® Elastic Rubber Bands

1 lb (0.45 kg) bag.

NVX595603 (595603) 1/16 x 2-1/2" .....	#16
NVX595611 (595611) 1/16 x 3" .....	#18
NVX595793 (595793) 1/16 x 3-1/2" .....	#19
NVX595629 (595629) 1/8 x 3" .....	#32
NVX595637 (595637) 1/8 x 3-1/2" .....	#33
NVX595645 (595645) assorted, .....	#54
NVX595652 (595652) 1/4 x 3-1/2" .....	#64
NVX595660 (595660) 3/8 x 3" .....	#73
NVX595678 (595678) 1/2 x 3-1/2" .....	#84
NVX595686 (595686) 1/8 x 7" .....	#117B



## C Offix® Elastic Rubber Bands

5 lb (2.27 kg) bag.

NVX344432 (344432) 1/16 x 3" .....	#18
NVX344440 (344440) 1/8 x 3-1/2" .....	#33
NVX344457 (344457) 1/4 x 3-1/2" .....	#64
NVX344424 (344424) 1/16 x 6" .....	#6 Th



## D High Quality Rubber Bands

Top quality, easy stretch. Box of 114 g (1/4 lb).

BSN 1914LB (1031285) 3-1/2 x 1/32" .....	#19
BSN 117B14LB (1031327) 7 x 1/8" .....	#117B



## E Elastic Rubber Bands

Best choice for everyday use. 1 lb (0.45 kg) bag.

BSN15750 (1031343) 1/8 x 1/16" .....	#8
BSN15725 (1031351) 1-1/4 x 1/16" .....	#10
BSN15730 (1031368) 1-3/4 x 1/16" .....	#12
BSN15739 (1031426) 2-1/2 x 1/8" .....	#31
BSN15751 (1031491) 3-1/2 x 1/2" .....	#84
BSN15726 (1031509) 5 x 5/8" .....	#105
BSN15727 (1031517) 7 x 5/8" .....	#107





**A**  

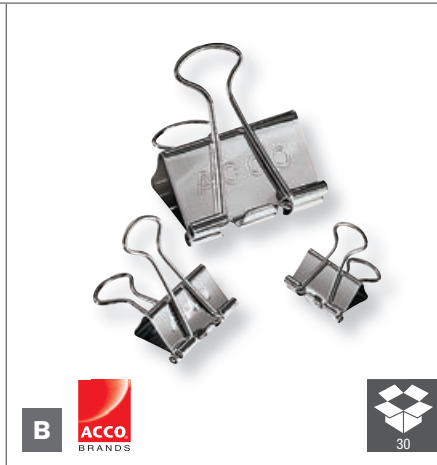

**B**  

**A Foldback Clips**

Strong metal clips with fold-back arms to securely bind thick stack of paper. Box of 12.  
**ACC 72010** (754895) 1/2" (cap. 1/4")  
**ACC 72020** (754903) 3/4" (cap. 5/16")  
**ACC 72022** (754911) 1" (cap. 3/8")  
**ACC 72050** (754945) 1-1/4" (cap. 5/8")  
**ACC 72024** (754929) 1-5/8" (cap. 7/8")  
**ACC72100** (754937) 2" (cap. 1-1/16")

**B Foldback Clips**

Box of 30. Includes 12 mini 1/2", 12 small 3/4", 6 medium 1-1/4". Polished silver.  
**ACC 71138** (716472)

**C Foldback Clips**

Box of 30. Includes 12 mini 1/2", 12 small 3/4", 6 medium 1-1/4". Polished. Assorted colours.  
**ACC 71130** (281691)



**C** 



**D** 

**D Foldback Clips**

Made of rust-resistant tempered steel. Size: 3/4 in (19mm). Capacity: 3/8 in (10mm). Assorted colours.  
**ACM 05255** (254946) package of 25  
**ACM 00500** (236380) box of 100

**E Offix® Foldback Clips**

Coated steel. Nickel plated arms. Box of 12.  
**NVX345066** (345066) 9/16" (cap. 1/4")  
**NVX345074** (345074) 3/4" (cap. 3/8")  
**NVX345082** (345082) 1" (cap. 1/2")  
**NVX345090** (345090) 1-1/4" (cap. 5/8")  
**NVX345108** (345108) 1-5/8" (cap. 7/8")  
**NVX345116** (345116) 2" (cap. 1")

**F Foldback Clips**

Assorted sizes. Package of 60. Black.  
**BSN 65369** (1030444)



**E**  



**F** 

**G Foldback Clips**

Assorted colours.  
**BSN 65360** (1030436) 9/16" (pkg 100)  
**BSN 65361** (809970) 3/4" (pkg 40)  
**BSN 65362** (1030353) 1-1/4" (pkg 24)  
**BSN 65363** (1030360) 2" (pkg 12)

**H Bulldog Clips**

Heavy-duty steel clip. Hang-up hole. Chrome plated. Box of 12.  
**ACM 15143** (659771) 1-1/4"  
**ACM 15125** (659797) 2"  
**ACM15107** (659789) 2-3/4"  
**ACM 15117** (513739) 3"



**I Bulldog Clips**

Heavy-duty clips. Chrome plated.  
**BSN 58500** (1030477) 1-1/4" (box 36)  
**BSN 58501** (1030485) 2-1/4" (box 36)  
**BSN58503** (1030667) 3" (box 12)

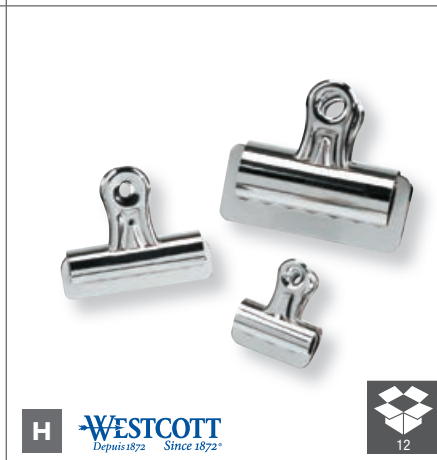

**G** 



**H**  



**I** 

**A Magnetic Bulldog Clips**

Metal spring-action clip riveted to magnet. Swivels on magnet. Box of 24.  
**ACC 71612** (573345) 1-1/2"  
**ACC 71613** (573352) 2"



**B Magnetic Bulldog Clips**

Magnetic head attached to spring-action clamp. Chrome.  
**BSN58506** (1030501) 1-1/4" (box 18)  
**BSN 58507** (1030519) 2-1/2" (box 12)

**C Magnetic Clips**

Square metal clip backed by a superior magnet. Nickel plated.  
**BSN 37512** (1030551) 1-1/2"  
**BSN 37510** (1030568) 2-1/4"

**D Coloured Paper Clips**

Metal with vinyl coating. Rust resistant.  
**Box of 100**  
**ACC72522** (754952) #1 (1-1/8")  
**ACC72523** (754960) #5 (2")  
**Box of 500**  
**ACC72524** (1030642) #1 (1-1/8")

**E Silver Paper Clips**

Zinc galvanized finish resists corrosion. Box of 100.  
**#1 (1-9/32")**  
**ACC 72380** (236356) smooth  
**ACC 72385** (236364) non-skid  
**#4 (1-7/8")**  
**ACC 72580** (263277) smooth  
**ACC 72585** (263269) non-skid

**F Recycled Paper Clips**

Smooth. Box of 100. 100% recycled content, 50% post-consumer.  
**ACC72365** (786095) #1 (1-9/32")  
**ACC 72525** (786103) #4 (1-7/8")

**G Offix® Paper Clips**

Nickel finish. Box of 100.  
**#1 (1-3/16")**  
**NVX345124** (345124) smooth  
**NVX345132** (345132) non-skid  
**#3 (15/16")**  
**NVX345140** (345140) smooth  
**#4 (1-7/8")**  
**NVX345157** (345157) non-skid

**H Vinyl-Coated Gem Clips**

Rust resistant. Assorted colours.  
**BSN 01605** (1030626) #1 (1-3/16") box 500  
**BSN 01604** (1030634) jumbo (2") box 250

**I Paper Clips**

Silver. 10 boxes of 100 paper clips.  
**#1 (1-3/16")**  
**BSN 65638** (1030345) smooth  
**BSN 65365** (1030576) non-skid  
**#4 (1-7/8")**  
**BSN 65639** (1030535) smooth  
**BSN 53366** (1030584) non-skid

**J Ideal Steel-Plated Paper Clamps**

Unique butterfly design prevents paper from tearing.  
**Small #2, 1-1/8 x 1-5/8", box of 50.**  
**ACC 72620** (301424)  
**Jumbo #1, 1-3/4" x 2-3/8", box of 12.**  
**ACC 72610** (301416)



## PRINTED ID PLATES AND BADGES

### Colour Printed Badge with Magnet

4-colour process printing.

ADK EP05A (367755) 5/8 x 2-1/2"

ADK EP04A (367748) 1 x 3"

ADK EP06A (367763) 1-1/2 x 3"



### Colour Printed Badge with Pin

4-colour process printing.

ADK EP05R (356477) 5/8 x 2-1/2"

ADK EP04R (356469) 1 x 3"

ADK EP06R (356485) 1-1/2 x 3"

## ENGRAVED ID PLATES AND BADGES

### Engraved Badge with Pin

One-colour engraved text.

ADK EP02R (356444) 5/8 x 2-1/2"

ADK EP01R (356436) 1 x 3"

ADK EP03R (356451) 1-1/2 x 3"



### Engraved Badge with Magnet

One-colour engraved text.

ADK EP02A (367722) 5/8 x 2-1/2"

ADK EP01A (367714) 1 x 3"

ADK EP03A (367730) 1-1/2 x 3"

### AVAILABLE COMBINATIONS

info	info
info	info
info	info
info	info
info	info
info	info
info	info
info	info

## COMBINED NAME PLATE & HOLDER

### Engraved Plate with Holder

Wall holder is mounted with self-adhesive strip or holes (screws not included).

Available with gold or silver holder.

With desktop holder

ADK PLSUB28 (356501) 2 x 8"

ADK PLSUB210 (356519) 2 x 10"

With wall holder

ADK PLSUM16 (356527) 1 x 6"

ADK PLSUM28 (356535) 2 x 8"

ADK PLSUM210 (356543) 2 x 10"



## HOLDERS FOR NAME PLATE

### Desktop Holder

Aluminum.

ADK 710-108 (356097) 2 x 8" - gold

ADK 720-108 (356105) 2 x 8" - silver

ADK 710-110 (356055) 2 x 10" - gold

ADK 720-110 (356063) 2 x 10" - silver

### Perpendicular Corridor Holder

Aluminum. With pre-drilled holes.

ADK 711-602 (356386) 2" - gold

ADK 721-602 (356410) 2" - silver

ADK 711-603 (356394) 3" - gold

ADK 721-603 (356428) 3" - silver

### Wall Holder

Aluminum. With pre-drilled holes.

ADK 710-506 (356378) 1 x 6" - gold

ADK 720-506 (356402) 1 x 6" - silver

ADK 712-308 (356089) 2 x 8" - gold

ADK 722-308 (356071) 2 x 8" - silver

ADK 712-310 (356113) 2 x 10" - gold

ADK 722-310 (356121) 2 x 10" - silver

### Occupied/Vacant Wall Sign

Gravopoly. Sliding sign. Assorted colours.

Choice of French or English.

ADK PLOC28 (357442) 2 x 8"

ADK PLOC210 (357459) 2" x 10"



## trodat® Printy Dater

For frequent or repetitive stamping, no need for separate stamp pad. 12-year unbreakable rubber bands. Replaceable cartridge. Available in black, blue, red, blue with red date. CO2 Climate neutral. 70% post-consumer recycled content.



TRODAT	SIZE	LINES	ENGLISH	FRENCH
4727	1-9/16 x 2-3/8"	Up to 6 lines	TRO 4727A (303040)	TRO 4727F (303057)
4729	1-3/16 x 2"	Up to 4 lines	TRO 4729A (303065)	TRO 4729F (303073)
4750	1 x 1-5/8"	Up to 2 lines	TRO 4750A (302604)	TRO 4750F (302612)
4813	3/8 x 1"	Up to 1 line	TRO 4813A (303081)	TRO 4813F (303099)
4850	3/16 x 1"	Up to 1 line	TRO 4850A (303107)	TRO 4850F (303115)
46145	1-3/4" Diameter	Up to 6 lines	TRO 46145A (303123)	TRO 46145F (303164)

## trodat® Die Plate Dater

Modern design with super strong material core makes this dater strong and reliable. For use with a stamp pad.



TRODAT	SIZE	LINES	ENGLISH	FRENCH
2910-P02	1-1/2 x 2"	Up to 4 lines	TRO 2910/P02A (302620)	TRO 2910/P02F (302638)
2910-P05	1-3/8 x 2-1/8"	Up to 4 lines	TRO 2910/P05A (303180)	TRO 2910/P05F (326942)
2910-P10	2 x 2-3/4"	Up to 6 lines	TRO 2910/P10A (302646)	TRO 2910/P10F (326843)
2910-P12	2" Diameter	Up to 6 lines	TRO 2910/U12A (303198)	TRO 2910/U12F (326983)
2910-P30	2" Diameter	Up to 8 lines	TRO 2910/P30A (302653)	TRO 2910/P30F (302661)

## trodat® Self Inking Professional Dater with Text

Offer reliability for years of use. The rugged metal frame is recommended for heavy industrial use areas such as factories and warehouses. 12-year unbreakable rubber bands. Ink cartridge is replaceable. Available in black, blue, red and blue with red date.



TRODAT	SIZE	LINES	ENGLISH	FRENCH
5430	1 x 1-5/8"	Up to 2 lines	TRO 5430A (354852)	TRO 5430F (354860)
5460	1-5/16 x 2-1/4"	Up to 4 lines	TRO 5460A (302539)	TRO 5460F (302562)
5474	1-9/16 x 2-3/8"	Up to 6 lines	TRO 5474A (598789)	TRO 5474F (598771)
5480	1-7/8 x 2-3/4"	Up to 8 lines	TRO 5480A (302570)	TRO 5480F (302588)

## trodat® Printy Self-Inking Stamp

For frequent or repetitive stamping, no need for separate stamp pad. Replaceable cartridge. Available in black, red, blue and green. CO2 Climate neutral. 65% post-consumer recycled material.



Your customized stamp ships within 7 to 10 days. See details on our website or ask your dealer or representative for more information.

TRODAT	SIZE	LINES	CODE
4910	3/8 x 1-1/32"	Up to 3 lines	TRO 4910 (353797)
4911	9/16 x 1-1/2"	Up to 3 lines	TRO 4911 (302414)
4912	3/4 x 1-7/8"	Up to 4 lines	TRO 4912 (302422)
4913	7/8 x 2-1/4"	Up to 5 lines	TRO 4913 (302430)
4933	1 x 1"	Up to 6 lines	TRO 4933 (598763)
4914	1 x 2-1/2"	Up to 5 lines	TRO 4914 (370478)
4915	1 x 2-3/4"	Up to 6 lines	TRO 4915 (302448)
4916	3/8 x 2-3/4"	Up to 2 lines	TRO 4916 (302455)
4917	3/8 x 1"	Up to 2 lines	TRO 4917 (373027)
4918	5/8 x 3"	Up to 2 lines	TRO 4918 (368043)
4921	1/2 x 1/2"	Up to 2 lines	TRO 4921 (302463)
4922	13/16 x 13/16"	Up to 4 lines	TRO 4922 (302471)
4923	1-3/16 x 1-3/16"	Up to 6 lines	TRO 4923 (364828)
4924	1-5/8 x 1-5/8"	Up to 9 lines	TRO 4924 (302497)
4925	1 x 3-1/4"	Up to 6 lines	TRO 4925 (302968)

TRODAT	SIZE	LINES	CODE
4926	1-1/2 x 3"	Up to 8 lines	TRO 4926 (302505)
4927	1-9/16 x 2-3/8"	Up to 9 lines	TRO 4927 (302513)
4928	1-5/16 x 2-3/8"	Up to 7 lines	TRO 4928 (302521)
4929	1-13/16 x 2"	Up to 8 lines	TRO 4929 (373035)
4931	1-3/16 x 2-3/4"	Up to 6 lines	TRO 4931 (370486)
4941	1 x 1-5/8"	Up to 6 lines	TRO 4941 (373126)
44055	Oval of 1-3/8 x 2-3/16"	Up to 6 lines	TRO 44055 (373142)
4612	1/2" Diameter	Up to 2 lines	TRO 4612 (598748)
46019	3/4" Diameter	Up to 4 lines	TRO 46019 (302976)
46025	1" Diameter	Up to 4 lines	TRO 46025 (373159)
46030	1-3/16" Diameter	Up to 6 lines	TRO 4630 (302984)
4638	1-1/2" Diameter	Up to 6 lines	TRO 4638 (598755)
46045	1-3/4" Diameter	Up to 6 lines	TRO 46045 (373167)
4642	1-5/8" Diameter	Up to 8 lines	TRO 4642 (302992)

**trodaf**  
**Mobile Printy Self-Inking Custom Stamp**

The intelligent technology enables opening, stamping, and closing with just one hand. The unique pyramid shape with stable 5-point support ensures optimal pressure distribution across the entire text plate guaranteeing smooth, clean imprints. The recessed ink cartridge prevents contact with the stamp's ink and keeps your fingers clean. 3/4" x 1 7/8" print area. Max 4 lines.



TRODAT	SIZE	LINES	CODE
9412	3/4 x 1 7/8"	Up to 4 lines	TRO 9412 (370460)

**trodaf**  
**Notary Custom Stamp**

For frequent or repetitive stamping, no need for separate stamp pad. Replaceable cartridge. Available in black, blue, red. CO2 Climate neutral. 65% post-consumer recycled content.



TRODAT	SIZE	LINES	ENGLISH	FRENCH
9430C	1-3/16" Diameter	Up to 2 lines	TRO 9430CA (354886)	TRO 9430CF (354894)

**Derome**  
**100 Years**

**Pre-Inked Stamps**

Personalized with your logo, signature or your own wording. Bottom mounted dust cover. Available in black, blue, red and green.



**i** Your customized stamp ships within 7 to 10 days. See details on our website or ask your dealer or representative for more information.

MODEL	SIZE	LINES	CODE
XL2-495	1-3/16" Diameter	—	ADK XL2-495 (598318)
XL2-535	1-5/8" Diameter	—	ADK XL2-535 (598300)
XL2-145	5/8 x 2-7/16"	Up to 2 lines	ADK XL2-145 (598425)
XL2-115	11/16 x 2"	Up to 2 lines	ADK XL2-115 (598482)
XK2-75	1/2 x 1-11/16"	Up to 3 lines	ADK XK2-75 (598276)
XK2-265	11/16 x 3-5/16"	Up to 3 lines	ADK XL2-265 (598284)
XL3-720	1 x 4"	Up to 4 lines	ADK XL2-720 (598417)
XL2-125	1 x 2"	Up to 5 lines	ADK XL2-125 (598409)
XL2-185	1-5/16 x 2-13/16"	Up to 5 lines	ADK XL2-185 (598342)
XL2-245	1-1/4 x 3-3/16"	Up to 6 lines	ADK XL2-245 (598367)
XL2-165	1-1/2 x 2-1/2"	Up to 7 lines	ADK XL2-165 (598391)
XL2-750	1-1/2 x 4-3/4"	Up to 8 lines	ADK XL2-750 (598334)
XL2-5050	2 x 2"	Up to 8 lines	ADK XL2-5050 (598375)
X36	2-1/4 x 3-3/4"	Up to 10 lines	ADK X36 (598383)
XL2-700	2-3/4 x 3-3/4"	Up to 12 lines	ADK XL2-700 (598326)
X39	3-1/8 x 4-1/2"	Up to 15 lines	ADK X39 (598359)

**Derome**  
**100 Years**

**Traditional Rubber Stamp**

Personalized with your logo, signature or your own wording. To be used with a stamp pad.



MODEL	SIZE	LINES	CODE
ES01	1/2 x 1-3/8"	Up to 2 lines	ADK ES01 (302810)
ES03	1/2 x 2"	Up to 2 lines	ADK ES03 (302836)
ES05	1/2 x 2-5/8"	Up to 2 lines	ADK ES05 (302828)
ES07	3/4 x 1-3/4"	Up to 4 lines	ADK ES07 (302869)
ES11	3/4 x 3"	Up to 4 lines	ADK ES11 (302844)
ES13	3/4 x 3-1/2"	Up to 4 lines	ADK ES13 (302851)
ES15	1 x 1-3/4"	Up to 6 lines	ADK ES15 (302885)
ES17	1 x 2-1/2"	Up to 6 lines	ADK ES17 (302877)
ES23	1-3/8 x 2-1/2"	Up to 7 lines	ADK ES23 (302893)
ES27	1-3/4 x 1-3/4"	Up to 8 lines	ADK ES27 (302901)
ES30	1-3/4 x 4"	Up to 8 lines	ADK ES30 (354878)
ES31	2-1/4 x 2-1/4"	Up to 10 lines	ADK ES31 (302919)
ES33	2-1/4 x 3-3/4"	Up to 10 lines	ADK ES33 (302935)
ES41	3-1/2 x 5"	Up to 24 lines	ADK ES41 (302943)

## A Typomatic DIY Self-Inking Stamp

Climate Neutral. Includes composer, pliers, PRINTY ink pad.  
Lifetime guarantee on mechanism. 65% post-consumer waste.  
**4911 - 3 lines - 3 mm**  
**TRO 67266** (719914)  
**4912 - 4 lines - 3 & 4 mm**  
**TRO 60419** (719930)



## B Typomatic DIY 4750 Dater With Text

Date format: month/day/year. Climate neutral. Do-it-yourself dater lets you create your own die plate dater. Create 2 lines of type (in blue), one line above the date (in red) and one line below the date. Offers 264-character capacity in 4 mm. 12-year date band. Includes tweezers. 70% post-consumer waste. Lifetime guarantee on mechanism.  
**TRO 144091** (281667)



## C Printy Self-Inking Custom Stamp With Online Voucher

Create your custom stamp on the Trodat web site with an easy-to-follow, step-by-step process. CO2 Climate neutral. 65% post-consumer recycled content. Black only.  
**4911 - 3 lines - 9/16 x 1-1/2 in.**  
**TRO 97453** (1042308)  
**4912 - 4 lines - 3/4 x 1-7/8 in.**  
**TRO 97454** (1042316)  
**4913 - 5 lines - 7/8 x 2-3/8 in.**  
**TRO 97455** (1042324)  
**4915 - 6 lines - 1 x 2-3/4 in.**  
**TRO97456** (428128)

Online voucher



## D 5756 Self-Inking Numbering Stamp

6 bands. 5.5 mm characters. 8 settings. Repetition 1, 2, 3, 4, 6, and 12 times. Plastic frame and handle.  
**TRO 27113** (719294)



## E Reiner B6K Self-Inking Automatic Numbering Stamp

High impact plastic frame and six alloy wheels. 9 settings: repeat and consecutive, duplicate 3, 4, 5, 6, 12 and 20 times. 4.5 mm characters.  
**TRO 27139** (750711)



## F Printy 4846 Self-Inking Numbering Stamp

Stamp with 6 bands. 5/32" characters. Lifetime guarantee on mechanism. 70% post-consumer waste.  
**TRO 73998** (719435)

## G Printy 4836 Self-Inking Numbering Stamp

Stamp with 6 bands. 3.8mm characters. Lifetime guarantee on mechanism. CO2 neutral using the maximum of post-consumer waste.  
**TRO 86547** (1042340)

## H Classic Numbering Stamp With Rubber Bands

Polished steel casing unbreakable plastic wheels. Six number bands. Lifetime warranty on mechanism.  
**TRO 28014** (566786) 4 mm  
**TRO 28015** (5272) 5 mm



Find Replacement pads on [page 585](#)





**A** trodat®



**B** trodat®



**A Printy Dater 4750 Self-Inking Date Stamp**

With plate. Plastic casing. Blue and red felt pad (included). 12-year date band. Lifetime guarantee on mechanism. 70% post-consumer recycled content.  
**TRO143907** (719286) REÇU/RECEIVED  
**TRO 143904** (719369) RECEIVED  
**TRO 64299** (719385) REÇU LE  
**TRO 143905** (719377) PAID  
**TRO143906** (719401) PAYÉ LE

**B Printy Dater 4810/4910 Self-Inking Pocket Dater**

3.5 mm. Very compact. 12-year date band. Lifetime guarantee on mechanism. 70% post-consumer recycled content.  
**TRO 70685** (719427) English  
**TRO 70266** (719419) French

**C Printy Dater 4817 Dial-a-Phrase Dater**

Self-inking. 12-year date band. 12 phrases in French. FAXÉ LE, PAR E-MAIL LE, REÇU LE, RÉPONDU LE, SAISI LE, RETOURNÉ LE, VÉRIFIÉ LE, PAYÉ LE, CONFIRMÉ LE, FACTURÉ LE, EXPÉDIÉ LE, COMPTABILISÉ LE. Post-consumer waste: 70%. Lifetime guarantee on mechanism.

**English - ANSWERED - BACKORDERED - CANCELLED - BILLED - RECEIVED - E-MAILED - CHECKED - DELIVERED - ENTERED - PAID - SHIPPED - FAXED**  
**TRO 80362** (719468)

**French - FAXÉ LE - PAR E-MAIL LE - REÇU LE - RÉPONDU LE - SAISI LE - RETOURNÉ LE - VÉRIFIÉ LE - PAYÉ LE - CONFIRMÉ LE - FACTURÉ LE - EXPÉDIÉ LE - COMPTABILISÉ LE**  
**TRO 80364** (719450)

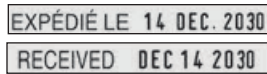

**C** trodat®



**D** trodat®



**D Printy Dater 4820 Self-Inking Dater**

Plastic casing. Black felt pad included. 12-year date band. Lifetime guarantee on mechanism. 70% post-consumer recycled content.  
**TRO 74005** (719146) English  
**TRO 74006** (719138) French

**E Printy 4850L Self-Inking Pocket Dater**

Blue text and red date. 12-year date band. Lifetime guarantee on mechanism. 70% post-consumer recycled content.

**English**  
**TRO 76753** (719492) RECEIVED  
**TRO 76754** (719500) PAID  
**TRO180473** (829713) EMAILED  
**TRO180474** (829714) SCANNED

**French**  
**TRO 76653** (719476) REÇU LE  
**TRO 76654** (719484) PAYÉ LE  
**TRO180475** (829715) ENVOYÉ PAR COURRIEL  
**TRO180476** (829716) NUMÉRISÉ

Find Replacement pads on **page 585**



**E** trodat®





## A Classic 1117 Dial-A-Phrase Dater

12-year date band. 12 phrases. Lifetime guaranty on mechanism.

**English - ANSWERED - CANCELLED - PAID - SHIPPED - ENTERED - COMPLETED - VOID - BILLED - RECEIVED - DELIVERED - FILED - APPROVED**

TRO28012 (719328)

**French - RÉPONDU - COMMANDÉ - EMBALLÉ - ANNULÉ - FACTURÉ - VÉRIFIÉ - RÉCLAMÉ - RETOURNÉ - LIVRÉ - PAYÉ - EXPÉDIÉ - REÇU**

TRO 28013 (719336)

RECEIVED DEC 14 2030 EXPÉDIÉ 14 DEC. 2030



## B Classic 2210 Manual Date Stamp with Text

Rubber plate. 12-year date band. Lifetime guarantee on mechanism.

TRO 28001 (719153) REÇU

TRO 28000 (719161) RECEIVED

TRO 28002 (719187) PAID

TRO 28003 (719179) PAYÉ



**A trodat**

**B trodat**

## C Manual Date Stamp

Polished steel casing and unbreakable plastic. Rubber band.

12-year date band. Lifetime warranty on mechanism.

**3 mm (#1) characters**

TRO 28006 (719252) English

TRO 28007 (719229) French

**4 mm (#1-1/2) characters**

TRO28008 (719245) English

TRO28009 (719237) French

**5 mm (#2) characters**

TRO 28010 (719278) English

TRO 28011 (719260) French

14 DEC. 2030 DEC 14 2030

## D Time/date Stamp 24 hours 2910

Print dates up to 12 years. Date perfectly aligned. Lifetime

guarantee on mechanism. 4 mm.

TRO 73084 (1042472)



**C trodat**

**D trodat**

## E S-Printy 4921 Self-Inking Small Size Stamp

1/2 x 1/2". One colour printing. Lifetime guarantee on mechanism.

TRO11406 (557520) MAPLE LEAF

TRO 05396 (762211) EXCELLENT - APPLE

TRO11389 (719625) SMILE

TRO11391 (719849) RED CIRCLE

TRO11393 (719666) OK

TRO11395 (719633) STAR

TRO 11399 (1042399) POSTED

TRO11429 (719831) 2 HEARTS

TRO11450 (557538) COPY

TRO97055 (549139) THUMBS UP

TRO 97463 (281659) CHECK



**E trodat**



REÇU LE  
A PARAPHER SVP  
COPIE  
PAYÉ  
A ARCHIVER  
A SCANNER  
URGENT  
POUR INFORMATION  
A SIGNER SVP  
VALIDÉ  
ANNULÉ  
RÉPONDU

ORIGINAL  
COPY  
E-MAILED  
FIRST CLASS  
CONFIDENTIAL  
CONFIRMATION  
CANCELLED  
FAXED  
DRAFT  
APPROVED  
URGENT!  
ENTERED

**A Printy 4822 Self-Inking Stamp**

12 phrases. Replaceable colour ink cartridge. Lifetime warranty on mechanism. 1-7/16 x 5/16".

English - ORIGINAL - COPY - E-MAILED - FIRST CLASS - CONFIDENTIAL - CONFIRMATION - CANCELLED - FAXED - DRAFT - APPROVED - URGENT! - ENTERED  
TRO 74046 (281675)

French - REÇU LE - À PARAPHER SVP - COPIE - PAYÉ À ARCHIVER - À SCANNER - URGENT - POUR INFORMATION - À SIGNER SVP - VALIDÉ - ANNULÉ - RÉPONDU  
TRO 74117 (281683)

**B Original Printy 4.0 4911 Self-Inking Large Size Stamp**

Climate Neutral. Non-toxic, water based ink. 1-1/2 x 1/2". One colour printing. Lifetime guarantee on mechanism. 65% post-consumer waste.

Bilingual

TRO 11325 (719641) ORIGINAL  
TRO 11328 (719559) URGENT!  
TRO11359 (1042381) ARROW  
TRO 97462 (205807) ID PROTECTION

English

TRO 11410 (230722) APPROVED (date)  
TRO11315 (557504) COMPLETED (date)  
TRO11314 (1042358) COMPLETED  
TRO 11327 (719781) CONFIDENTIAL  
TRO 11326 (719773) COPY  
TRO11600 (557546) CLIENT COPY  
TRO11308 (719732) CREDIT  
TRO 11316 (101089) DRAFT  
TRO 11493 (610683) E-MAILED  
TRO 11311 (281618) ENTERED (date)  
TRO11330 (1042365) FAXED  
TRO 11331 (719765) FAXED (date)  
TRO11409 (1042373) FILE  
TRO11317 (534412) FILE COPY  
TRO 11411 (230730) FINAL SALE  
TRO11337 (566695) FOR DEPOSIT ONLY  
TRO 11305 (719567) PAID  
TRO 11306 (719575) PAID (date)  
TRO 97057 (225086) PARENT SIGNATURE  
TRO11340 (566703) PAST DUE  
TRO 11349 (101048) POSTED  
TRO 11350 (393603) POSTED (date)  
TRO 11333 (719609) RECEIVED (date)  
TRO11304 (549121) RUSH!  
TRO 97464 (137216) SCANNED  
TRO11357 (557512) VOID

French

TRO 11377 (719682) ANNULÉ  
TRO 97465 (230755) APPROUVÉ (date)  
TRO 11380 (719724) CONFIDENTIEL  
TRO 11364 (719716) COPIE  
TRO 11363 (719674) CRÉDIT  
TRO 11408 (719708) FAXÉ LE (date)  
TRO 97470 (137232) NUMÉRISÉ  
TRO 97469 (137224) PAR COURRIEL (date)  
TRO 11407 (719690) PASSÉ DÛ  
TRO 11367 (719583) PAYÉ  
TRO 11368 (719591) PAYÉ (date)  
TRO 11385 (282756) POUR DÉPÔT SEULEMENT  
TRO 11369 (719617) REÇU (date)  
TRO 97056 (225060) SIGNATURE DU PARENT  
TRO 11435 (230748) VENTE FINALE

**A trodat**



**B trodat**





## A Stamp-Ever Ink

For reinking "Stamp-Ever" ink pads. 7 ml.  
**ADK ESCN** (170423) black  
**ADK ESCB** (170431) blue  
**ADK ESCR** (170449) red



## B Felt Ink Pad

Provides thousands of clean crisp impressions. Re-inkable. Secure snap-close lid. Made of 85% recycled content.

**#1 - 2-3/4 x 4-3/8 in.**  
**TRO 56347** (584870) black  
**TRO 56344** (584896) blue  
**TRO 56346** (584888) red  
**#2 - 3-1/2 x 6-3/8 in.**  
**TRO 56363** (719898) black  
**TRO 56360** (719880) blue  
**TRO 56362** (719906) red



## C 7011 Premium Ink for Stamp Pad

28 ml bottle. Non-toxic, water-based.  
**TRO 22711** (786236) black  
**TRO 22712** (786244) blue  
**TRO 22713** (786251) red  
**TRO55884** (342386) green



## D Rotary Stamp Holder

For 8 stamps. Plastic support, metal base.  
 1 level. Grey.  
**TRO 54771** (719922)



## Refill cartridges

TRODAT	SIZE	UNIT	BLACK (REF.)	BLUE (REF.)	RED (REF.)	BLUE/RED (REF.)
<b>FOR TRODAT PRINTY STAMP</b>						
4910	3/8 x 1"	pkg 2	TRO 97436 (786327)	-	TRO 97446 (1042514)	-
4911	9/16 x 1-1/2"	pkg 2	TRO 97044 (786293)	TRO 4880 (786277)	TRO 4882 (786285)	-
4912	3/4 x 1-7/8"	pkg 2	TRO 97434 (137190)	TRO 97449 (293035)	TRO 97448 (137208)	-
4913	7/8 x 2-1/4"	pkg 2	TRO 97435 (293043)	TRO 97451 (326751)	TRO 97450 (338368)	-
4914	1 x 2-1/2"	each	TRO 47257 (374736)	TRO 47260 (374843)	TRO 47258 (374835)	-
4915	1 x 2-3/4"	each	TRO 69594 (320689)	TRO 69732 (320747)	TRO 69733 (320705)	-
4916	3/8 x 2-3/4"	each	TRO 72686 (320895)	TRO 72682 (320804)	TRO 72683 (320796)	-
4917	3/8 x 2"	each	TRO 80369 (719443)	TRO 80370 (320861)	TRO 80371 (320879)	-
4918	5/8 x 3"	each	TRO 20213 (374231)	TRO 20214 (374330)	TRO 20215 (374439)	-
4921	1/2 x 1/2"	pkg 2	TRO 97452 (293050)	TRO 97433 (786319)	TRO 97432 (786301)	-
4922	13/16 x 13/16"	each	TRO 69810 (356782)	TRO 69853 (326504)	TRO 69851 (356790)	-
4924	1-5/8 x 1-5/8"	each	TRO 69806 (356808)	TRO 69819 (356816)	TRO 69821 (356824)	-
4925	1 x 3-1/4"	each	TRO 9670 (356832)	TRO 9667 (356840)	TRO 9669 (356857)	-
4926	1-1/2 x 3"	each	TRO 70666 (320697)	TRO 97012 (320754)	TRO 70668 (320713)	-
4927	1-9/16 x 2-3/8"	each	TRO 74185 (293076)	TRO 74182 (293084)	TRO 74184 (293092)	-
4928	1-5/16 x 2-3/8"	each	TRO 80491 (356865)	TRO 81175 (356873)	TRO 81177 (356881)	-
4929	1-13/16 x 2"	each	TRO 4592 (356972)	TRO 4509 (338343)	TRO 4591 (356980)	-
4941	1 x 1-5/8"	each	TRO 59965 (326538)	TRO 59966 (326546)	TRO 59967 (326512)	-
46045	1-3/4" Diameter	each	TRO 80808 (357012)	TRO 80809 (357020)	TRO 80810 (357038)	-
<b>FOR TRODAT PROFESSIONAL DATER</b>						
5430	1 x 1-5/8"	each	TRO 62104 (326520)	TRO 62107 (320820)	TRO 62109 (320812)	TRO 73990 (727867)
5460	1-5/16 x 2-1/4"	each	TRO 55608 (320846)	TRO 55605 (320853)	TRO 55607 (320838)	TRO 72809 (293068)
5470	1-9/16 x 2-3/8"	each	TRO 78193 (375311)	TRO 78049 (375287)	TRO 78051 (375303)	-
5480	1-7/8 x 2-3/4"	each	TRO 74516 (320887)	TRO 74517 (320903)	TRO 74518 (320911)	TRO 74521 (338350)
<b>FOR TRODAT PRINTY DATER</b>						
4726	1-1/2 x 3"	each	TRO 70666 (320697)	TRO 97012 (320754)	TRO 70668 (320713)	-
4727	1-9/16 x 2-3/8"	each	TRO 74185 (293076)	TRO 74182 (293084)	TRO 74184 (293092)	-
4729	1-3/16 x 2"	each	TRO 4592 (356972)	TRO 4509 (338343)	TRO 4591 (356980)	TRO 4508 (356655)
4750	1 x 1-5/8"	each	TRO 59965 (326538)	TRO 59966 (326546)	TRO 59967 (326512)	TRO 67809 (719393)
4813/4817	3/8 x 1"	each	TRO 80369 (719443)	TRO 80370 (320861)	TRO 80371 (320879)	-
4820	1-1/2 x 1/4"	pkg 2	TRO 97044 (786293)	TRO 4880 (786277)	TRO 4882 (786285)	-
4850	3/16 x 1"	each	TRO 97046 (178541)	TRO 97048 (178558)	TRO 97049 (178566)	TRO 76553 (719518)
46145	1-3/4" Diameter	each	TRO 80808 (357012)	TRO 80809 (357020)	TRO 80810 (357038)	-
<b>FOR TRODAT PRINTY NUMBERER</b>						
4846	1-1/2 x 1/4"	pkg 2	TRO 97044 (786293)	TRO 4880 (786277)	TRO 4882 (786285)	-
5756	-	pkg 2	TRO 27053 (727834)	-	-	-
REINER B6K	-	pkg 3	TRO 27121 (727842)	-	-	-



# Imagination

Workers want to introduce colour and fun into their work life. In this section you will find writing instruments in as many colours as you can imagine alongside an array of crafting and hobby accessories.

# WRITING AND CREATIVITY

---

## WRITING AND CORRECTION

Pens .....	<b>589</b>
Pencils .....	<b>612</b>
Correction .....	<b>617</b>
Non-Permanent Markers .....	<b>620</b>
Permanent Markers .....	<b>625</b>
Highlighters .....	<b>631</b>

---

## ARTS AND CRAFTS

Paints and Supplies .....	<b>635</b>
Modeling Clay and Accessories .....	<b>639</b>
Arts and Crafts Supplies .....	<b>640</b>
Stencils .....	<b>643</b>
Arts and Crafts Paper .....	<b>644</b>
Drawing and Drafting Supplies .....	<b>646</b>
Colouring .....	<b>650</b>

---

## LEISURE AND GAMES

Passtime Activities .....	<b>656</b>
Playhouses and Toy Boxes .....	<b>656</b>
Games .....	<b>657</b>
Puzzles .....	<b>657</b>



# Writing Instrument Selector Guide

SMOOTH

## Ballpoint Extended Write-Out

- Durable, non-water based ink
- Virtually smudge-free: great for lefties
- Economical stick versions offer extended write-out: best for high-usage areas like service counters, warehouses
- Point won't tear thin pages: ideal for signing multi-part forms and contracts
- Small rotating ball dispenses ink as you push pen across page

FINE

MEDIUM

BOLD

SMOOTHER

## Advanced Ink System Effortless Writing

- Pens using Advanced Ink Systems provide unparalleled smoothness because the optimized delivery systems reduce friction between the tip and the paper when writing
- Unique ink viscosities (lower than typical Ball Pens, higher than Rollerball and Gel pens) allow an even flow on paper for improved colour vibrancy and brilliance on paper
- Advanced Ink Systems are convenient for lefties because they dry more quickly than most gel pen inks resulting in limited to no smearing
- Advanced Ink Systems require minimal pressure from your hand when writing, so they are ideal for all writing occasions; from short notes to essays

MEDIUM

SMOOTHER

## Porous Point Everyday Writing and Drawing

- Quick drying, water-based ink resists smearing and won't bleed through paper
- Felt tip great for bold marking with minimal effort
- Available in a variety of colour choices
- Ideal for everyday writing and drawing

FINE

MEDIUM

SMOOTHER

## Gel ink, with smooth writing and bold colours, are growing in popularity

- Pigmented ink produces bold, bright colours
- Smooth writing experience and exceptional control
- Reliable performance of a ballpoint with the smooth write of a rollerball
- Many colour choices - all acid free and archival-safe for professional portfolios, scrapbooks
- Great for all writing needs, especially those requiring a degree of permanency: best for legal documents or checks

ULTRA MICRO

MICRO

NEEDLE

MEDIUM

BOLD

SMOOTHEST

## Rollerball Smoothest Writing

- Fluid, skip-free writing
- Consistent ink delivery to tip
- Rich, dramatic colours
- Uses water-based liquid ink that yields a smooth wet line on page
- Ideal for letters or memos

MICRO

NEEDLE

FINE

BOLD

# Paper Mate®

## Profile®

WITH A WIDE VARIETY OF INK AND LEAD OPTIONS, THE COMFORTABLE GRIP AND SMOOTH PRECISION OF PROFILE PRODUCTS ARE SURE TO BE THE PERFECT FIT FOR ALL OF YOUR WRITING NEEDS.



Profile®  
MECH®

Profile®  
BALL®

Profile®  
GEL®

### Paper Mate® Profile Mech® Mechanical Pencil

Products	Description
PAP 2101947	0.7mm, 36/box
PAP 2105705	0.7mm, 8/pk

### Paper Mate® Profile Ball® Pen

Products	Description
PAP 2095462	1.0mm, Blue, 12/box
PAP 2095470	1.0mm, Black, 12/box
PAP 2095454	1.0mm, Red, 12/box

### Paper Mate® Profile Gel® Pen

Products	Description
PAP 2095472	0.7mm, Blue, 12/box
PAP 2095476	0.7mm, Black, 12/box
PAP 2095463	0.7mm, Red, 12/box



**A** Paper Mate



**B** Paper Mate



**A Paper Mate® InkJoy® Gel Pens**

Vivid gel ink that dries 3X faster for reduced smearing. Comfortable grip. Smooth writing. Assorted colours. Pack of 6.

**PAP 2162814** (828325) pastel colours (0.7 mm)

**PAP 2162815** (828326) bright colours (0.7 mm)

**PAP1959310** (371450) assorted colours (0.5 mm)

**A InkJoy® Gel Retractable Ballpoint Pen**

Super smooth ink gel system, dries quickly. Rubberized grip. 0.7 mm.

By each

**PAP 1953045** (353284) black

**PAP 1953046** (353292) blue

**PAP 1953047** (353300) red

**PAP 1953049** (353268) light blue

**PAP 1953511** (353318) purple

**PAP 1953513** (353326) pink

**PAP 1953517** (353342) green

**PAP 1953518** (353359) teal

Package of 14

**PAP 1959302** (371443) assorted colours



**C** Sharpie



**D** Sharpie



**C Sharpie S.Gel Retractable Pens**

Gel ink. Superior colour intensity for smooth writing and no smearing. Contoured grip for comfortable writing. Box of 12.

0.5 mm

**SAN2096146** (828408) blue

**SAN2096145** (828879) black

**SAN2096166** (828409) red

0.7 mm

**SAN2096152** (599191) blue

**SAN2096159** (599209) black

**SAN2096158** (599019) red

**SAN2126216** (805987) green

**SAN2126235** (805995) violet

**SAN2126232** (828407) black (grey barrel)

**SAN2126236** (828406) black (white barrel)

1.0 mm

**SAN2096187** (599183) blue

**SAN2096149** (599167) black

**SAN2096136** (599175) red



**E** Sharpie



**F** uni



**D Sharpie S.Gel Premium Pens**

Gel ink. Superior colour intensity for smooth writing and no smearing. Sleek metal barrel and professional look. Contoured grip for comfortable writing. 0.7 mm. Box of 12.

**SAN2147525** (806000) blue

**SAN2147528** (806026) black

**E Sharpie S.Gel Pens**

No smear, no bleed technology and bold, best-in-class ink. Contoured rubber grip. Package of 2. Black ink. Medium point. 0.7 mm.

**SAN 2144799** (828323) white barrel

**SAN 2144800** (828324) blue barrel

**SAN2147524** (828875) black barrel

**F Impact Gel RT Retractable Rollerball Pen**

Anti-fraud gel ink. Visible ink level. Rubberized grip. 1.0 mm point.

Sold by each.

**UBC 65871** (630426) blue

**UBC 65870** (630418) black

**G Gel Grip Rolling Ballpoint Pen**

Gel ink helps prevent cheque fraud. Rubberized grip. Visible ink level. Medium point. Sold by each.

**UBC 65451** (475210) blue

**UBC 65450** (475202) black

**UBC 65452** (475228) red



**G** uni



**H** uni



**H Gel RT Retractable Rollerball Pen**

Rechargeable gel ink. Rubberized grip. Medium point. Sold by each.

**UBC 65941** (606616) blue

**UBC 65940** (606392) black

**UBC 65942** (606608) red



## A 207 Plus+ Retractable Gel Pens

Gel-based nano fiber ink with a rich, clean line. Rubberized grip. The ink dries very quickly. The Super Ink™ Plus technology prevents document alteration and fading. 0.7 mm medium tip.

Package of 3

UBC 70456 (832562) black

Package of 12

UBC 70463 (831359) blue

UBC 70462 (831358) black

UBC 70464 (831360) red



**A** uni

**N**  
2023

**B** uni

**N**  
2023



## B 207 Fashion Retractable Gel Pens

Water and fade-resistant gel ink. Translucent barrels. Medium point. 0.7 mm. Package of 8. Assorted colour

UBC1739929C (828348)

## C uni® Spectrum Retractable Gel Pens

Smooth-flowing, vibrant gel ink. Translucent barrel. Medium point, 0.7 mm.

Package of 3

UBC 70182C (828345) blue

UBC 70181C (828344) black

Package of 6

UBC70183C (828340) assorted colours



**C** uni

**N**  
2023

**D** uni



## D 207 Retractable Gel Pen

Specially formulated gel ink that helps prevent against cheque and important document fraud. Rubberized grip. Refillable.

By each - 0.5 mm

UBC 61256 (767798) blue

UBC 61255 (767780) black

UBC 61257 (767806) red

By each - 0.7 mm

UBC 33951 (705731) blue

UBC 33950 (705723) black

UBC 33952 (705749) red

By each - needle point, 0.7 mm

UBC 1736098 (777649) blue

UBC 1736097 (777631) black

By each - 1.0 mm

UBC 1790896 (165332) blue

UBC 1790895 (165324) black

Box of 36 - 0.7 mm

UBC1921064 (425306) blue

UBC1921063 (426627) black

## E B2P Retractable Rollerball Pen

Gel ink. Retractable and refillable. Sold by each. 89% post-consumer content.

PIL BGBLB2P7BE (130377) blue

PIL BGBLB2P7BK (130385) black

PIL BGBLB2P7RD (130401) red

PIL BGBLB2P7GN (130393) green



**E** 



**F** 

## F G2 Retractable Roller Pen

Gel ink. Contoured rubberized grip. Refillable.

By each - 0.5 mm

PIL 163128 (479121) blue

PIL 163104 (479097) black

PIL 163111 (479139) red

By each - 0.7 mm

PIL 163180 (479113) blue

PIL 163166 (479105) black

PIL 163173 (479089) red

PIL BLG27-GN (309575) green

By each - 1.0 mm

PILBLG210BE (526384) blue

PILBLG210BK (551945) black

Box of - 0.7 mm

PILG27L-6 (134908) blue

PILG27B-6 (134890) black



## G Begreen® G-Tec-C4 Grip Rollerball Pen

Gel ink. Rubberized grip. 0.4 mm ultra fine needle point. Refillable. 74% recycled content.

PIL 325335 (759233) blue

PIL 325328 (759241) black



**G** 



# ENERGEL®

#1 GEL PEN

QUICK DRYING  
SÉCHAGE RAPIDE DE L'ENCRE



BL77 - 0.7mm

BL407 - 0.7mm

BLN75 - 0.5mm



Discover the best  
**Pentel**

### Pentel EnerGel Retractable Gel Rollers

An effortless writing experience. Internally tested to be smoother writing than the leading gel pen on standard writing paper. Liquid gel ink dries fast. Left-handed writers love it; no smears, no smudges, no globs. Refillable with using LR7 or LRN5 refills. Reduce your environmental impact by refilling your pens.

- BL407 - 0.7mm**
- Silver.....PEN BL407-A
- Black..... PENBL407A-A
- Aquamarine PENBL407LS-A
- Brown..... PENBL407MA-A
- Pink..... PENBL407P-A
- Purple ..... PENBL407V-V
- Gold.....PENBL407X-A
- BLN75 - 0.5mm**
- Black.....PEN BLN75-A
- Red.....PEN BLN75-B
- Lilac..... PEN BL77-V3
- Blue.....PEN BLN75-C
- BL77 - 0.7mm**
- Black.....PEN BL77-A
- Red ..... PEN BL77-B
- Blue ..... PEN BL77-C
- Green..... PEN BL77-D
- Orange.....PEN BL77-F
- Pink..... PEN BL77-P
- Coral Pink... PEN BL77-P3
- Purple ..... PEN BL77-V

## A EnerGel® Rollerball Pen

Gel ink dries so fast even left-handed writers love it. Rubberized grip. Metal tip. Medium Point. 50% recycled content.

By each - 0.7 mm

- PENBL57-C (102889) blue
- PENBL57-A (102863) black
- PENBL57-B (102871) red

By each - 1.0 mm

- PEN BL60-C (788448) blue
- PEN BL60-A (788422) black
- PEN BL60-B (788430) red

Box of 12 - 0.7 mm

- PENBL57-D (241695) green
- PENBL57-V (241703) purple



**A** **Pentel**



**B** **Pentel**



## B EnerGel® X Rollerball Pen

Liquid gel ink. Very smooth writing experience, quick drying time and vivid colours. Translucent tinted body. Rubberized grip. Sold by each. 84% recycled content.

0.5 mm

- PEN BLN105-C (165415) blue
- PEN BLN105A (165399) black
- PEN BLN105B (165407) red

0.7 mm

- PEN BL107-C (165449) blue
- PEN BL107A (165423) black
- PEN BL107-B (165431) red

1.0 mm

- PEN BL110-C (808626) blue
- PEN BL110-A (536409) black



**C** **Pentel**



**D** **Pentel**



## C EnerGel® NV Rollerball Pen

Combines the best qualities of liquid and gel inks for a super-smooth writing experience. Great for left-handed writers. 0.5 mm point. Sold by each. 71% recycled content.

- PEN BLN25-C (343582) blue
- PEN BLN25-A (343590) black
- PEN BLN25-B (596635) red



**E** **Pentel**



**F** **BIC**



## D EnerGel Retractable Ballpoint Pen

Water resistant, light-fast and fade resistant gel ink. Stylish modern look with metal pocket clip. 0.5 mm point. Sold by each.

- PEN BLP75-C (578997) blue
- PEN BLP75-A (587030) black

## E EnerGel® Rollerball Pen

Liquid gel ink. Very smooth writing experience, quick drying time and vivid colours. Rubberized grip. Non-refillable. Sold by each. 53% recycled content.

0.5 mm

- PEN BLN15-C (644823) blue
- PEN BLN15-A (644849) black
- PEN BLN15-B (644831) red

0.7 mm

- PEN BL17-C (644864) blue
- PEN BL17-A (644856) black
- PEN BL17-B (644872) red

## F Gel-Ocity™ Original Retractable Rollerball Pens

Smooth writing gel ink. 0.7 mm point.

Package of 4

- BIC RLCP41BL (140483) blue
- BIC RLCP41BK (140491) black

Box of 12

- BICRLC11BL (241547) blue
- BICRLC11BK (241539) black

Box of 24

- BIC RLC241-BE (1010289) blue
- BIC RLC241-BLK (428573) black

## G Gel-Ocity™ Retractable Rollerball Pens

Quick dry super smooth writing gel ink. Medium point.

Package of 2

- BIC 428615 (428615) blue
- BIC 428607 (428607) black

































Package of 8

- BIC RGLCGAP81A (428649) assorted colours



**G** **BIC**

























 <p><b>A</b></p>  	 <p><b>B</b></p>  	 <p><b>C</b></p>  	<p><b>A Z-Grip Max Retractable Gel Pen</b>                      Rubberized grip. Medium point. Sold by each.  <b>ZEB 42220</b> (766329) blue  <b>ZEB 42210</b> (766311) black  <b>ZEB 42230</b> (766337) red  <b>ZEB 42240</b> (766345) green  <b>ZEB 42280</b> (766352) violet</p> <p><b>B Sarasa® Retractable Rollerball Pen</b>                      Gel ink. Rubberized grip. Visible ink level. Refillable. Sold by each.  <b>0.5 mm</b>  <b>ZEB46720</b> (428508) blue  <b>ZEB46710</b> (595298) black  <b>ZEB46730</b> (595280) red  <b>1.0 mm</b>  <b>ZEB 46620</b> (103457) blue  <b>ZEB 46610</b> (103440) black  <b>ZEB 46630</b> (103465) red</p>
 <p><b>D</b></p>  	 <p><b>E</b></p>  	 <p><b>F</b></p>  	<p><b>C Jimmie® Rolling Ballpoint Pen</b>                      Water-based pigment gel ink. Acid-free. Archival-quality. Rubberized grip. Medium point. Sold by each.  <b>ZEB 44120</b> (602623) blue  <b>ZEB 44110</b> (602615) black</p> <p><b>D Z-Grip Ballpoint Pen</b>                      Gel ink. Rubberized grip, translucent barrel and metal clip. 0.7 mm. Sold by each.  <b>ZEB 44420</b> (595314) blue  <b>ZEB 44410</b> (595322) black</p> <p><b>E Z-Grip™ Retractable Gel Pen</b>                      Soft rubber grip for comfort and control. Acid-free, archival-quality. Non-refillable. 0.7 mm. Sold by each.  <b>ZEB 42420</b> (595694) blue  <b>ZEB 42410</b> (536425) black  <b>ZEB 42430</b> (1009893) red  <b>ZEB 42440</b> (1009885) green</p>
 <p><b>G</b></p>  	  <p><b>H</b></p>  	<p><b>F GR8 Gel Retractable Rollerball Pen</b>                      Gel ink. Rubberized grip. Acid-free, archival-quality. 0.7 mm point. Sold by each.  <b>ZEB 42620</b> (103382) blue  <b>ZEB 42610</b> (103374) black  <b>ZEB 42630</b> (103390) red  <b>ZEB 42680</b> (103523) purple</p> <p><b>G Retractable Gel Ink Pens</b>                      Permanent, water-resistant gel ink. Comfortable rubber grip and tough metal tip. Non-refillable. Box of 12.  <b>0.5 mm</b>  <b>ITA36157</b> (1009547) blue  <b>ITA36156</b> (1009539) black  <b>ITA36158</b> (1009555) red  <b>0.7 mm</b>  <b>ITA30036</b> (1009778) blue  <b>ITA30035</b> (1009760) black  <b>ITA36159</b> (1009521) red</p>	
 <p><b>I</b></p>   	 <p><b>J</b></p>   	<p><b>H Gel Stick Pens</b>                      Permanent, water-resistant. Smooth write. Include chrome metal clips and tips. Non-refillable. 0.7 mm point. Box of 12.  <b>ITA 39060</b> (1009852) blue  <b>ITA 39059</b> (1009869) black</p> <p><b>I Offix® Retractable Rolling Ball Pen</b>                      Gel ink. Visible ink level. Rubberized grip. 0.7 mm point. Sold by each.  <b>NVX344119</b> (344119) blue  <b>NVX344101</b> (344101) black  <b>NVX344127</b> (344127) red</p> <p><b>J Offix® Rolling Ballpoint Pen</b>                      Gel ink. Rubberized grip. Sold by each.  <b>NVX 343913</b> (343913) blue (0.5 mm)  <b>NVX 343921</b> (343921) blue (0.7 mm)  <b>NVX 344093</b> (344093) red (0.7 mm)</p>	



FIND  
ZEN  
IN YOUR PEN  
**ZEBRA**



SARASA **dry** X20

 <p><b>A</b></p>  	 <p><b>B</b></p>   	<p><b>A Z-Grip Max Retractable Ballpoint Pen</b>                  Translucent silver barrel with rubberized grip. Metal pocket clip. 1.0 mm point. Sold by each.  <b>ZEB 22420</b> (342808) blue  <b>ZEB 22410</b> (342790) black  <b>ZEB 22430</b> (321430) red</p> <p><b>B Z-Grip Flight Retractable Ballpoint Pens</b>                  Rubberized grip. The ink colour matches the colour of the barrel. 1.2 mm point. Box of 12.  <b>ZEB 21920</b> (234906) blue  <b>ZEB 21910</b> (234898) black  <b>ZEB 21930</b> (234914) red  <b>ZEB 21940</b> (234922) green  <b>ZEB 21970</b> (234930) fuchsia  <b>ZEB 21980</b> (242859) purple</p>
 <p><b>C</b></p>  	 <p><b>D</b></p>   	<p><b>C Z-Mulsion EX Retractable Ballpoint Pen</b>                  Emulsion ink combining oil and water. Bold writing line with quick-drying. Smear resistant. Rubberized body. 1.0 mm point. Sold by each.  <b>ZEB 34220</b> (188748) blue  <b>ZEB 34210</b> (188730) black  <b>ZEB 34230</b> (188763) red</p> <p><b>D OLA Retractable Ballpoint Pens</b>                  Offers a unique, comfortable writing experience with its moulded rubber barrel and grip to the tip. This pen is ideal for long exams and essay writing. Medium point. Box of 12.  <b>ZEB 23520</b> (567800) blue  <b>ZEB 23510</b> (570895) black  <b>ZEB 23530</b> (550095) red  <b>ZEB 23580</b> (808493) violet</p>
 <p><b>E</b></p>   	 <p><b>F</b></p>  	<p><b>E Jimmie Clip Eco Retractable Ballpoint Pen</b>                  Spring loaded clip. Rubberized grip. Refillable. Medium point. 1.0 mm. Sold by each. 72% post-consumer recycled content.  <b>ZEB 22520</b> (711549) blue  <b>ZEB 22510</b> (711556) black  <b>ZEB 22530</b> (711531) red</p> <p><b>F Z-Grip™ Retractable Ballpoint Pen</b>                  Rubberized grip. Medium point. Sold by each.  <b>ZEB 22220</b> (711572) blue  <b>ZEB 22210</b> (711564) black  <b>ZEB 22230</b> (711580) red  <b>ZEB 22240</b> (711598) green  <b>ZEB 22280</b> (711606) purple</p>
 <p><b>G</b></p>   	 <p><b>H</b></p>  	<p><b>G F-301 Ballpoint Pens</b>                  Stainless steel barrel with metal clip. 0.7 mm point. Box of 12.  <b>ZEB 27120</b> (240960) blue  <b>ZEB 27110</b> (240952) black</p> <p><b>H Telescopic Retractable Ballpoint Pen</b>                  Metal barrel. Extend for writing, retract for storage. Refillable. Medium point. Sold by each. Black.  <b>ZEB 10110</b> (567776)</p>

## A ComfortMate Ultra® Ballpoint Pens

"Floating Ball" ink system. Rubberized grip. Medium point. Box of 12.

PAP 6110187 (140046) blue  
PAP 6130187 (140061) black

## B ComfortMate Ultra® Retractable Ballpoint Pens

"Floating Ball" ink system. Rubberized body. Triangular shape. Box of 12.

**Medium point**  
PAP 6310187 (140145) blue  
PAP 6330187 (140160) black  
PAP 6320187 (140152) red  
**Fine point**  
PAP 6360187 (140129) blue  
PAP 6380187 (140137) black



A Paper Mate

B Paper Mate

## C InkJoy™ 100 Ballpoint Pens

Translucent coloured body. 1.0 mm point.

**Package of 10**  
PAP 1782970 (564799) assorted colours  
**Box of 12**  
PAP 1951256 (165290) blue  
PAP 1951257 (165282) black



## D InkJoy™ 100 Retractable Ballpoint Pens

Super smooth low viscosity ink system. Triangular barrel. 1.0 mm point.

**Package of 8**  
PAP1945935 (234765) assorted colours  
**Box of 12**  
PAP 1951253 (234740) blue  
PAP 1951254 (234732) black  
PAP 1951252 (234757) red



C Paper Mate

D Paper Mate

## E InkJoy™ 300 Retractable Ballpoint Pens

Smooth low viscosity ink system. Rubberized grip. 1.0 mm point.

**Package of 8**  
PAP1945922 (319285) blue, black, red  
**Box of 12**  
PAP 1951259 (165266) blue  
PAP 1951260 (165233) black  
PAP 1951258 (165274) red  
**Box of 36**  
PAP 1951378 (425322) black



E Paper Mate

F Paper Mate

## F InkJoy™ 700 Retractable Ballpoint Pens

Effortless glide writing system which provides the incredible smoothness of a gel and the fast drying of a ball pen. Hourglass shape sculpted to fit the contour of your hand. Medium point. Box of 12.

PAP 1951346 (433789) blue  
PAP 1951347 (433797) black

## G Profile® Retractable Ballpoint Pen

Super bold and extra smooth writing. Requires little to no pressure. Rubberized grip. 1.4 mm point.

**By each**  
PAP 87206 (228999) blue  
PAP 87205 (228981) black  
**Package of 4**  
PAP 1938165 (319301) assorted colours



G Paper Mate

H Paper Mate

## H Write Bros.® Ballpoint Pens

Designed for comfortable writing. Ultra-low viscosity ink.

**Fine point - box of 12**  
PAP 2124512 (806050) blue  
PAP 2124515 (806067) black  
PAP 2124517 (806075) red  
**Medium point - box of 12**  
PAP331131C (660423) blue  
PAP331131C (660407) black  
PAP3321131C (660415) red  
**Medium point - box of 60**  
PAP 4621501C (232884) blue  
PAP 4621401C (232876) black



**A** Paper Mate



**B** Paper Mate



**A FlexGrip Elite® Ballpoint Pens**

"Floating Ball" ink system. Comfortable barrel. Medium point. Box of 12.  
**PAP 85586** (140004) blue  
**PAP 85585** (139998) black

**B FlexGrip Elite® Retractable Ballpoint Pen**

"Floating Ball" ink system. Rubberized barrel. Sold by each.  
**Medium point**  
**PAP 85581** (712174) blue  
**PAP 85580** (712166) black  
**Fine point**  
**PAP 85583** (712190) blue  
**PAP 85582** (712182) black

**C Flexgrip Ultra™ Ballpoint Pen**

"Floating Ball" ink system. Rubberized body. Sold by each. 55% recycled content.  
**Medium point**  
**PAP 9610131** (135558) blue  
**PAP 9630131** (135574) black  
**PAP 9620131** (135566) red  
**Fine point**  
**PAP 9660131** (135525) blue  
**PAP 9680131** (135541) black



**C** Paper Mate



**D** Paper Mate



**D Flexgrip Ultra® Retractable Ballpoint Pen**

"Floating Ball" ink system. Rubberized body. Sold by each. 55% recycled content.  
**Medium point**  
**PAP 9510131** (437491) blue  
**PAP 9530131** (437509) black  
**Fine point**  
**PAP 9560131** (321562) blue  
**PAP 9580131** (321570) black

**E Acroball™ Retractable Ballpoint Pen**

Stylish design with metal clip. Newly developed ink formula for ultra smooth, water resistant, smear proof performance. Unique, comfortable textured grip. Retractable & refillable. Sold by each.  
**PIL BPAB25M-BE** (105635) blue  
**PIL BPAB25M-BK** (105643) black  
**PIL BPAB25M-RD** (105650) red



**E** PILOT

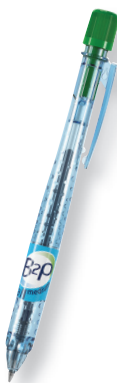

**F** PILOT



**F B2P Retractable Ballpoint Pen**

Oil-based ink. Retractable & refillable. Medium point. Sold by each. 96% post-consumer content.  
**PILBGBPB2PMBE** (181321) blue  
**PILBGBPB2PMBK** (181339) black  
**PILBGBPB2PMRD** (181354) red  
**PILBGBPB2PMGN** (181347) green

**G Better® Retractable Ballpoint Pens**

Stainless steel tip. Fine point. Slip proof grip. Retractable & refillable. Translucent body. Box of 12.  
**PIL 829587** (829587) blue  
**PIL 829586** (829586) black



**G** PILOT



**H** PILOT



**H BPS Ballpoint Pen**

Stainless steel tip. Oil-based ink. Refillable. Sold by each.  
**Medium point**  
**PIL 084645** (38588) blue  
**PIL 084621** (38612) black  
**PIL 084638** (38604) red  
**PIL 084652** (38596) green  
**Fine point**  
**PIL 084584** (37481) blue  
**PIL 084560** (37499) black  
**PIL 084577** (37507) red  
**PIL 084591** (37515) green



## A Super Grip G Ballpoint Pen

Oil based ink for ultra-smooth and smear-resistant writing. Refillable. Sold by each.

### Medium point

- PIL BPSGGM-BE (595587) blue
- PIL BPSGGM-BK (595595) black
- PIL BPSGGM-RD (595579) red

### Fine point

- PIL BPSGGF-BE (595553) blue
- PIL BPSGGF-BK (595546) black
- PIL BPSGGF-RD (595561) red



## B Super Grip Retractable Ballpoint Pen

Tinted barrel matches ink colour. Large rubberized grip. Refillable. 0.7 mm. Sold by each.

- PIL BPGP10RFBE (309450) blue
- PIL BPGP10RFBK (309559) black

## C Jetstream Elements Ballpoint Pens

The low viscosity oil-based ink provides a similar experience to a gel pen. Uni Super INK™ protects against water, fading and fraud. 1.0 mm point.

### Package of 3

- UBC70180 (828346) assorted colours
- UBC 70320 (828347) blue

### Box of 12

- UBC 70124 (828351) blue
- UBC 70123 (828350) black
- UBC 70125 (828352) red



## D Jetstream Element Retractable Ballpoint Pens

The low viscosity oil-based ink provides a similar experience to a gel pen. Uni Super INK™ protects against water, fading and fraud. 1.0 mm point. Package of 5. Assorted colours.

- UBC 70138C (817858)



## E JetStream™ Ballpoint Pen

Hybrid anti-fraud ink prevents cheque and document alteration. Quick-dry. Excellent for left-handed users. Sold by each.

### 0.7 mm

- UBC 40174 (728246) blue
- UBC 40173 (728238) black

### 1.0 mm

- UBC 33922 (705707) blue
- UBC 33921 (705699) black
- UBC 33923 (705715) red



## F JetStream™ Retractable Ballpoint Pen

Hybrid ink. Quick-drying ink prevents smearing. Fade and water resistant. Rubberized body. Sold by each.

### 0.7 mm

- UBC 62153 (776807) blue
- UBC 62152 (776799) black

### 1.0 mm

- UBC 73833 (752089) blue
- UBC 73832 (752071) black
- UBC 73834 (103135) red



## G Power Tank™ Retractable Ballpoint Pen

Pressurized ink. Writes on wet surfaces, in cold temperatures and even upside down. 1.0 mm point. Sold by each.

- UBC 42071 (712299) blue
- UBC 42070 (712281) black



## H Dr Grip COG Retractable Ballpoint Pen

Large comfortable rubberized grip reduces writing stress and fatigue. Designed with equal weight distribution to improve ease of writing. Oil based. Medium point. Blue ink.

- PILBPDG60R-BK (786673)

- Package of 2 refills
- PIL BRFM-L (751487) blue





**A Ecolutions™ Ocean Retractable Ballpoint Pens**

Made of 78% ocean-bound recycled plastic. Smooth writing. Medium point 1.0 mm. Package of 4. Blue.  
**BIC BPRRP41BLU** (832578)

**B Ecolutions™ Round Stic® Ballpoint Pens**

Made of 97% recycled plastic. Long lasting ink. 1.0 mm medium point. Package of 10. Blue.  
**BICGSME10-BLU** (832576)

**C Ecolutions™ Clic Stic® Retractable Ballpoint Pens**

Made of 78% recycled plastic. Long lasting ink. 1.0 mm medium point. Package of 10. Blue.  
**BICCSEM10-BLU** (832577)

**D Atlantis® Original Retractable Ballpoint Pens**

Easy-Glide System®. Rubberized grip. 1.0 mm. Box of 12.  
**BICVCG11BE** (140095) blue  
**BIC VCG11-BK** (140103) black



**E Atlantis® Velocity Bold™ Retractable Ballpoint Pens**

Proprietary easy glide system ink technology for a super-smooth writing experience. 1.6 mm point.

**Box of 12**  
**BIC VLGB11BL** (388108) blue  
**BIC VLGB11BK** (388090) black

**Box of 36**  
**BIC 805003** (805003) blue  
**BIC 805011** (805011) black

**F Soft Feel® Retractable Ballpoint Pens**

Rubberized body. Medium point. 1.0 mm.

**Box of 12**  
**BICSCSM11-BL** (155614) blue  
**BICSCSM11-BK** (155622) black  
**BICSCSM11RE** (155630) red

**Box of 24**  
**BIC SC SMB24BBE** (804971) blue  
**BIC SC SMB24BBK** (804989) black



**G Round Stic® Grip Ballpoint Pens**

Easy Glide ink system. Rubberized grip. Box of 12.

**Medium point**  
**BIC GSMG11-BL** (660639) blue  
**BIC GSMG11-BK** (660621) black  
**BIC GSMG11-RD** (660613) red

**Fine point**  
**BIC GSGF11-BL** (660597) blue  
**BIC GSGF11-BK** (660605) black

**H Clic Stic® Retractable Ballpoint Pens**

Sturdy clip. Medium point.

**Box of 12**  
**BIC CSM11BL** (351429) blue  
**BIC CSM11BK** (351411) black

**Box of 24**  
**BIC CSM241-BLK** (428565) black





Made with  
at least

**50%** RECYCLED  
PLASTIC

IN 100% RECYCLED/RECYCLABLE PACKAGING



**BICBP41BLU**  
Ecolutions™ Ocean  
Retractable Pen 4 pack Blue



**BICMER12-BLK**  
Ecolutions™ Permanent  
Marker 12 pack Assorted



**BICWOET10-WHT**  
Wite-out® Brand Ecolutions™  
Mini Correction Tape  
10 pack White



**BICWOET21-WHT**  
Wite-out® Brand Ecolutions™  
Mini Correction Tape  
2 pack White



**BICMPE12-BLK**  
Ecolutions™ Mechanical Pencil 0.7mm  
12 pack Assorted Barrel Colours



**BICSEM10-BLU**  
Ecolutions™ Clic Stic®  
Retractable Pen 10 pack Blue



**BICGSME10-BLU**  
Ecolutions™ Round Stic®  
Ball Pen 10 pack Blue

Let's work to help Write the Future Together



**A**

**Pentel**



**B**

**Pentel**



**C**

**Pentel**



**A R.S.V.P. Retractable Ballpoint Pens**

Bright coloured barrels are easy to find in tool boxes and active work environments. Rubberized grip. 1.0 mm point. Package of 2. One of each : yellow and orange. Black ink.  
**PEN 829613** (829613)

**B R.S.V.P.® Ballpoint Pen**

Rubberized grip. Sold by each.  
**0.7 mm**  
**PEN BK90C** (389197) blue  
**PEN BK90A** (389171) black  
**PEN BK90B** (389189) red  
**PENBK90D** (389205) green  
**PENBK90P** (422774) pink  
**PENBK90S** (682708) sky blue  
**PEN BK90V** (422782) purple  
**1.0 mm**  
**PEN BK91-C** (479071) blue  
**PEN BK91-A** (479055) black  
**PEN BK91B** (479063) red  
**1.0 mm. Box of 12**  
**PENBK91D** (373621) green  
**PENBK91V** (373613) purple

**C R.S.V.P.® Retractable Ballpoint Pen**

Rubberized grip. 1.0 mm. Sold by each. 61% recycled content.  
**PEN BK93-C** (161091) blue  
**PEN BK93A** (161075) black  
**PEN BK93B** (161083) red  
**PEN BK93CRD-D** (808550) green  
**PENBK93CRS-S** (1009166) sky blue  
**PENBK93CRV-V** (1009174) purple

**D Retractable Ballpoint Pens**

Triangular barrel. Medium point, 1.0 mm. Box of 12.  
**PEN BK440-A** (808568) blue  
**PEN BK440-A** (808576) black  
**PEN BK440-B** (373647) red

**E Round Stic® Ballpoint Pens**

Easy Glide ink system.  
**Medium point - box of 12**  
**BIC GSM11-BL** (660555) blue  
**BIC GSM11-BK** (660563) black  
**BIC GSM11-RD** (660589) red  
**Fine point - box of 12**  
**BIC GSF11-BL** (660522) blue  
**BIC GSF11-BK** (660530) black  
**Medium point - box of 60**  
**BICGSM609BL** (102517) blue  
**BICGSM609BK** (349795) black

**F Cristal® Ballpoint Pens**

Easy Glide ink system. Clear barrel. Medium point, 1.0 mm. Box of 12.  
**BIC MS11C-BL** (111963) blue  
**BIC MS11C-BK** (111971) black  
**BIC MS11C-RED** (111997) red

**G Offix® Ballpoint Pens**

Medium Point. Box of 12.  
**NVX343855** (343855) blue  
**NVX343863** (343863) black  
**NVX343871** (343871) red

**H Offix® Ballpoint Pen**

Rubberized barrel. Sold by each.  
**Medium point**  
**NVX343749** (343749) blue  
**NVX343756** (343756) black  
**NVX343764** (343764) red  
**Fine point**  
**NVX343772** (343772) blue  
**NVX343780** (343780) black  
**NVX343798** (343798) red



**D**

**Pentel**



**E**

**BIC**



**F**

**BIC**



**G**

**offix**



**H**

**offix**



**I**

**offix**



**I Offix® Retractable Ballpoint Pen**

Rubberized barrel. Sold by each.  
**Medium point**  
**NVX 343806** (343806) blue

**NVX 343814** (343814) black  
**Fine point**  
**NVX 343822** (343822) blue  
**NVX 343830** (343830) black

## A Slider Memo XB Ballpoint Pens

Viscoglide technology. Ink dries quickly and is smudge proof when highlighting it later on. Ergonomic shape. Large point.

**Pack of 3**

**PSYRS150293** (806695) assorted colours

**Box of 10**

**PSYRS150203** (302927) blue

**PSYRS150201** (300541) black

**PSYRS150202** (300559) red



## B Slider Edge Ballpoint Pens

Viscoglide® technology. Black ink waterproof to ink standard ISO 12757-2. Ink dries quickly and is smudge proof when highlighting it later on. Rubberized three-edged barrel.

**Medium point - package of 3**

**PSY RS75200** (300533) assorted colours

**Medium point - box of 10**

**PSYRS152103** (806711) blue

**PSYRS152101** (806703) black

**Large point - box of 10**

**PSYRS152203** (806737) blue

**PSYRS152201** (806729) black

## C Tops 505 Ballpoint Pens

With clip cap and stainless steel tip. Medium point.

**Package of 4**

**PSY RS75063** (806778) blue

**PSY RS75060** (806760) assorted colours

**Box of 10**

**PSY RS150803** (806753) blue

**PSY RS150801** (806745) black

## D Easy Click Retractable Ballpoint Pens

Textured rubber grip and plastic clip. Box of 12. Black.

**ITA 82955** (1009083) medium

**ITA82952** (1009075) fine

## E Retractable Ballpoint Pens

Rubberized barrel. Medium point. Box of 12.

**ITA 30032** (1008953) blue

**ITA30031** (1008945) black

## F Retractable Ballpoint Pens

Rubberized grip. Medium point.

**Box of 12**

**ITA 36176** (1009349) blue

**ITA 36175** (1009331) black

**ITA 36177** (1009357) red

**Box of 50**

**ITA 36192** (1008929) assorted colours

## G Retractable Ballpoint Pens

Triangular shape with smooth plastic barrel. Plastic clip.

Medium point. Box of 12. 100 % post-consumer content.

**ITA38090** (1008812) blue

**ITA 38089** (1008820) black

## H Ballpoint Stick Pens

**Fine point - box of 12**

**BSN 37502** (1008978) blue

**BSN37503** (1008986) black

**Medium point - box of 12**

**BSN37500** (1008994) blue

**BSN37501** (1009000) black

**BSN 37504** (1009026) red

**Medium point - box of 60**

**BSN 37532** (1009018) blue

**BSN 37531** (1008960) black

## I Ballpoint Retractable Pens

Medium point. Box of 12.

**BSN 25051** (1009050) blue

**BSN 25050** (1009067) black





**A 4-Color™ 3+1 Retractable Ballpoint Pen + Pencil**

Retractable ballpoint pen and a 0.7 mm mechanical pencil. Includes 2HB leads and eraser refills. Perfect for recording data in different colours without having to switch pens. Medium point. Pocket clip. 3 ink colours (blue, black, red).

**BIC MMLP1-AST** (428599)

**B 4 Color™ Retractable Ballpoint Pen**

4 colours in 1 pen. Perfect for recording data in different colours without having to switch pens. Pocket clip. 1.0 mm point. 4 colours in one pen (black, blue, red and green).

**BICMMP11** (649269) by each - blue/white  
**BIC MMPGP1** (561290) by each - grey/black  
**BIC MPP31-AST** (832575) pkg 3 - blue/white

**C EnerGel® 2S Multi-Function Gel Roller Pen**

High-performance EnerGel® ink technology combines the best qualities of liquid and gel inks for a super-smooth writing experience. Includes a 0.5 mm mechanical pencil. Black and red ink.

**PEN BLW355A** (601534)

**D V Disposable Fountain Pen**

Ideal for everyday use. Stainless steel tip for smooth writing. No maintenance and easy to use. Medium point. Visible ink supply. Sold by each.

**PIL 281648** (177683) blue  
**PIL 281624** (177675) black  
**PIL 281686** (750448) purple



Pen and pencil 3 in 1



**E Security Pen**

Square adhesive base. Medium ballpoint pen. 24 in. chain. Sold by each. Black.

**MGE 38C5403100** (547919)

**F Security Pen With Adhesive Base**

Round adhesive base. Base fastens to any clean, flat surface. Metal chain reaches up to 24 in. Sold by each. Black.

**MGESP617BL** (276337)  
 • Refills - package of 2  
**MGE 3872412120** (716928)

**G Integra Antimicrobial Counter Pen**

Self-adhesive round base. Antimicrobial pen with rubberized barrel. 24 in ball chain. Sold by each. Black.

**ITA 38648** (1008663) pen with base  
 • Replacement pen  
**ITA 38646** (1008671)

**H Security Pen with Base**

Medium point. Black.  
**MGE SP628BX** (605774)

• Refills - package of 2  
**MGE 3872412120** (716928)



## A Jotter Originals Ballpoint Pen

Meet the original design icon capturing thoughts and inspiring new ideas since 1954. Combining Jotter's distinctive silhouette, its signature click and the arrow clip with a bold colour palette, Jotter Originals is true to its origins. Stainless steel body. Medium point. Sold by each. Blue ink.  
**PAR 2076052** (599225)

## B IM Retractable Ballpoint Pen

Durable stainless steel ballpoint. Glossy black lacquer barrel. Quinkflow ballpoint ink is extra smooth with better ink flow. Presented in a gift box. Medium point. Sold by each. Black ink.  
**PAR 1975553** (572750)

## C Sterling Rollerball Pen

High quality gel ink. Glossy and lacquered barrel. All-metal. Refillable. Presented in a gift box. 0.7 mm tip. Sold by each. Black ink.

**PEN K611ALR7AE** (428946) black  
**PEN 428961** (428961) violet

## D Energel® Retractable Rollerball Pen

Combines the best of liquid and gel ink for super-smooth writing. Liquid gel ink dries quickly and leaves no smears or smudges. Perfect for left-handed people. Metallic and sleek barrel. Refillable. Presented in a gift box. 0.7 mm tip. Sold by each. Black ink.

**PEN BL2007SAE1** (428920) blue  
**PEN BL2007AAE1** (546275) black  
**PEN BL2007ZAE1** (428938) silver

## E Z-1000 Stylus and Pen

2 in 1. Stylus for touch screen (tablet). 1.0 mm point. Sold by each. Black ink.

**ZEB33221** (214536) blue barrel  
**ZEB33211** (214528) black barrel

## F Telescopic Styluspen™

Extends to full length when writing and easily retracts for storage. Quality brass construction. 1.0 mm point and stylus point for touch screens. Sold by each. Black ink.

**ZEB 33611** (567693) black barrel  
**ZEB 33641** (559211) green barrel  
**ZEB 33661** (559229) blue barrel

## G 2 in 1 InkJoy® Stylus Pen

Combines the superior writing experience of InkJoy with a stylus tip. 1.0 mm point. Sold by each. Blue ink.

**PAP 1951349** (350835)



**A** PARKER

**B** PARKER



**C** Pentel

**D** Pentel



**E** ZEBRA

**F** ZEBRA

**G** Paper Mate

# FRIXION FAMILY HAS A NEW CLICKER!

## MEET **FRIXION**<sup>point</sup> CLICKER

ERASABLE

- > New innovative Synergy Tip combining needle tip and conical point for silky smooth writing
- > High ink capacity inside Synergy Tip allows rich ink flow
- > Thermo-sensitive gel ink that disappears with friction using the rubber tail tip on the pen with no residue and no tearing of paper
- > Side click retractable
- > Refillable

### Frixion® Point Clicker 0.5mm Retractable Erasable Pen

PIL BLRTFRP5BE (828266) blue  
 PIL BLRTFRP5BK (828267) black  
 PILBLRTFRP5BB (832702) blue black  
 PIL BLRTFRP5RD (828268) red  
 PIL BLRTFRP5GN (828269) green  
 PIL BLRTFRP5PE (828271) violet  
 PIL BLRTFRP5PK (828270) pink  
 PIL BLRTFRP5TE (828272) turquoise  
**Refill Frixion® Point & Point Clicker**  
 PIL 399336 (160762) blue  
 PIL 399312 (160770) black  
 PILBLSFRP5-BB (829627) blue black  
 PIL 399329 (160895) red  
 PIL BLSFRP5-GN (160812) green  
 PIL BLSFRP5-PE (160861) purple  
 PIL BLSFRP5-PK (160879) pink  
 PIL BLSFRP5-TE (160911) turquoise



Traditional Conical Tip



**FRIXION**<sup>point</sup> CLICKER

**FRIXION**<sup>ball</sup> CLICKER

FRIXION LETS YOU



WRITE



ERASE



REWRITE



Exclusively from

MADE IN JAPAN

**Note:** For better results, do not expose pens to extreme temperatures. Erasable pens are not recommended for use on legal or permanent documents.

[www.crestar.ca](http://www.crestar.ca)



@crestarltd



Find the refills on page 606

## A FriXion® Ball Erasable Gel Rollerball Pen

FriXion® lets you write, erase, re-write. Thermo-sensitive gel ink disappears with erasing friction coming from the rubber tip. Refillable. Not recommended for legal or official documents. 0.7 mm.

**Sold by each**

- PIL 322723** (786871) blue
- PIL 322709** (786889) black
- PIL 322716** (786897) red
- PIL BLFR7-GN** (105536) green
- PILBLFR7-AO** (1000967) apricot
- PILBLFR7-CP** (1000975) coral pink
- PIL BLFR7-LG** (551929) light green
- PILBLFR7-LP** (1000983) light purple
- PIL BLFR7-OR** (105569) orange
- PIL 322754** (105544) violet
- PIL BLFR7-PK** (105551) pink
- PILBLFR7-SK** (1000991) sky blue
- PIL BLFR7-TE** (105577) turquoise
- PILBLFR7-WR** (1001007) wine

**Package of 6**

- PIL004382** (112011) assorted colours
- 0.7 mm refill - by each**
- PIL BLSFR7BE** (160739) blue
- PIL BLSFR7BK** (160747) black
- PIL BLSFR7RD** (160754) red
- PIL BLSFR7GN** (162834) green
- PIL BLSFR7OR** (161224) orange
- PIL BLSFR7PE** (161232) purple
- PIL BLSFR7PK** (161240) pink
- PIL BLSFR7TE** (161257) turquoise
- PILBLSFR7BB** (829631) blue/black



**A** **PILOT**



**B** **PILOT**

## B FriXion® Point Erasable Gel Rollerball Pen

FriXion® lets you write, erase, re-write. Thermo-sensitive gel ink disappears with erasing friction coming from the rubber tip. Refillable. Not recommended for legal or official documents.

Needle point. 0.5 mm. Sold by each.

- PIL 399237** (134809) blue
- PIL 399213** (134791) black
- PIL 399220** (134817) red
- PIL 399244** (134825) green
- PIL 399251** (134833) purple
- PIL 399275** (134858) pink
- PIL 399268** (134841) turquoise
- PILBLFRP5-BB** (829626) blue/black

## C FriXion® Ball Clicker Retractable Erasable Pen

FriXion® lets you write, erase, re-write. Thermo-sensitive gel ink disappears with erasing friction coming from the rubber tip. Side click retractable and refillable. Not recommended for legal or official documents.

**0.5 mm**

- PIL BLRTRFR5BE** (162842) blue
- PIL BLRTRFR5BK** (162859) black
- PIL BLRTRFR5RD** (162891) red
- PIL BLRTRFR5GN** (162867) green
- PIL BLRTRFR5PE** (162875) purple
- PIL BLRTRFR5PK** (162883) pink
- PIL BLRTRFR5TE** (162909) turquoise
- PILBLRTRFR5BB** (829628) blue/black

**0.7 mm**

- PIL BLRTRFR7BE** (162917) blue
- PIL BLRTRFR7BK** (162925) black
- PIL BLRTRFR7RD** (162966) red
- PIL BLRTRFR7GN** (162933) green
- PIL BLRTRFR7PE** (162941) purple
- PIL BLRTRFR7PK** (162958) pink
- PIL BLRTRFR7TE** (162974) turquoise
- PIL BLRTRFR7BB** (829630) blue/black

**0.7 mm - package of 3**













- PILFR7AST3** (309989) assorted colours
- 0.5 mm refill - by each**
- PIL BLSFR5-BE** (206896) blue
- PIL BLSFR5-BK** (206912) black
- PIL BLSFR5-RD** (206961) red



**C** **PILOT**

- PIL BLSFR5-GN** (206920) green
- PIL BLSFR5-PE** (206938) purple
- PIL BLSFR5-PK** (206946) pink
- PIL BLSFR5-TE** (206979) turquoise
- PILBLSFR5-BB** (829629) blue/black



 <p><b>A</b> </p>	 <p><b>B</b> </p>	<p><b>A Hi-Tecpoint V5 / V7 Rollerball Pen</b>                  Needle point tip for precise writing &amp; drawing. Ink regulator for a perfect flow. See-through ink barrel. Liquid ink. Sold by each.  <b>0.5 mm - V5</b>  <b>PIL 085703</b> (34702) blue  <b>PIL 085680</b> (34728) black  <b>PIL 085697</b> (34710) red  <b>PIL 085710</b> (185363) green  <b>PIL 085741</b> (249557) purple  <b>PIL 085895</b> (249573) pink  <b>PIL 085727</b> (249565) turquoise  <b>0.7 mm - V7</b>  <b>PIL 085765</b> (194662) blue  <b>PIL 085758</b> (194688) black  <b>PIL 085772</b> (194670) red  <b>PIL 085789</b> (230003) green</p>
 <p><b>C</b> </p>	 <p><b>D</b> </p>	<p><b>B Hi-Tecpoint RT Retractable Rollerball Pen</b>                  Retractable needle point for precise writing &amp; drawing. Rubberized grip for superior comfort. Airplane safe. Liquid ink. Refillable. Sold by each.  <b>0.5 mm</b>  <b>PIL 342882</b> (777839) blue  <b>PIL 342868</b> (777847) black  <b>PIL 342875</b> (777854) red  <b>0.7 mm</b>  <b>PIL 342967</b> (777862) blue  <b>PIL 342943</b> (777870) black  <b>PIL 342950</b> (777888) red</p> <p><b>C V-Ball Grip Rolling Ballpoint Pen</b>                  Rubberized grip for superior comfort. See-through ink barrel. Liquid ink. Refillable. Sold by each.  <b>0.5 mm</b>  <b>PIL 322846</b> (750588) blue  <b>PIL 322822</b> (750596) black  <b>PIL 322839</b> (750612) red  <b>PIL 322853</b> (750604) green  <b>0.7 mm</b>  <b>PIL 322921</b> (750620) blue  <b>PIL 322907</b> (750638) black  <b>PIL 322914</b> (750653) red  <b>PIL 322938</b> (750646) green</p>
 <p><b>E</b> </p>	 <p><b>F</b>  </p>	<p><b>D Hi-Tecpoint Grip V5 / V7 Rolling Ballpoint Pen</b>                  Needle point tip for precise writing &amp; drawing. Rubberized grip for superior comfort. See-through ink barrel. Liquid ink. Sold by each.  <b>0.5 mm - V5</b>  <b>PIL 279713</b> (707190) blue  <b>PIL 279690</b> (707208) black  <b>PIL 279706</b> (707224) red  <b>PIL 279720</b> (707216) green  <b>PIL 315671</b> (746461) violet  <b>PIL 315657</b> (746479) pink  <b>PIL 315664</b> (746487) turquoise  <b>0.7 mm - V7</b>  <b>PIL 279799</b> (707232) blue  <b>PIL 279775</b> (707240) black  <b>PIL 279782</b> (707265) red  <b>PIL 279805</b> (707257) green  <b>PIL 315732</b> (746495) purple  <b>PIL 315718</b> (746503) pink  <b>PIL 315725</b> (746511) turquoise</p>

**F GreenTecpoint Rolling Ballpoint Pen**  
 Liquid ink. Smooth and precise writing. Airplane safe. Refillable. 0.5 mm needle point. Sold by each. 89% recycled content.  
**PIL 345197** (777698) blue  
**PIL 345173** (777706) black  
**PIL 345180** (777714) red

**E V-Signpen Marker**  
 Liquid ink. Medium point tip with ink regulator for perfect ink flow. Visible ink supply. Sold by each.  
**PIL 134678** (326785) blue  
**PIL 134654** (326793) black  
**PIL SWVSP-RD** (326801) red

## A Sharpie Roller Pens

Needle point of 0.5 mm for ultimate writing precision. Premium metal clip for a professional finish. Translucent grip that indicate ink colour. Box of 12.

**SAN 2093199** (599027) blue  
**SAN 2093225** (599035) black  
**SAN 2093226** (599043) red



**A** Sharpie®



## B One Business Rollerball Pens

The innovative Super-Flow-System guarantees consistent ink flow from start to finish. The large ink reservoir has a level indicator. The cap-off ink does not run dry even if the cap is removed for 2-3 days. 0.6 mm point. Box of 10.

**PSYRS183003** (806794) blue  
**PSYRS183001** (806786) black



**B** Schneider



## C Onyx Rollerball Pens

Strong metal tip produces smooth, consistent writing. Durable plastic clip. Box of 12.

**0.5 mm**  
**UBC 60041** (140293) blue  
**UBC 60040** (140285) black  
**UBC60042** (140301) red

**0.7 mm**  
**UBC 60145** (140319) blue  
**UBC 60143** (140327) black  
**UBC60144** (140335) red



**C** uni



**D** uni



## D Roller™ Rollerball Pens

Durable metal clip. Quick-drying ink. Smooth writing. Box of 12. 80% post-consumer content.

**0.5 mm**  
**UBC 60153** (140236) blue  
**UBC 60151** (140210) black  
**UBC 60152** (140228) red  
**UBC60154** (140244) green

**0.7 mm**  
**UBC60103** (140277) blue  
**UBC 60101** (144345) black  
**UBC60102** (140269) red



**E** uni



**F** uni



## E Vision™ Rollerball Pen

Specially formulated anti-fraud ink (except pink and purple). Visible ink level.

**0.5 mm needle point - by each**  
**UBC1734919** (777771) blue  
**UBC1734918** (777763) black  
**0.5 mm needle point - by each**  
**UBC1734904** (777730) blue  
**UBC1734903** (777722) black

**Micro point - by each**  
**UBC60108** (323303) blue  
**UBC 60106** (808337) black  
**UBC 60117** (565309) red

**Fine point - by each**  
**UBC 60134** (330829) blue  
**UBC 60126** (330811) black  
**UBC 60386** (809251) green  
**UBC 60382** (228973) purple  
**UBC 60139** (330837) red

**Fine point - box of 36**  
**UBC1921066** (572602) black



**G** uni



**H** offix



## F Signo 207 Colours Retractable Rollerball Pen

Specially formulated ink that helps prevent against cheque and important document fraud. Rubberized grip. Refillable. Medium point. 0.7 mm. Sold by each.

**UBC 1754844** (227470) blue  
**UBC 1754843** (227462) black



**G** uni



**H** offix



## G Vision Elite™ Rollerball Pen

Black ink infused with colour. Specially formulated anti-fraud ink. Visible ink level. Fade-resistant and acid-free. Will not leak on airplane. Sold by each.

**0.5 mm**  
**UBC 69021** (655738) blue

**UBC69020** (655746) blue/black  
**0.8 mm**  
**UBC 69024** (655704) blue  
**UBC 61102** (641035) black  
**UBC 61232** (641043) blue/black

## H Offix® Rolling Ballpoint Pen

Liquid ink. Visible ink level. Rubberized grip. Sold by each.

**0.5 mm**  
**NVX 343897** (343897) blue  
**0.7 mm**  
**NVX 343905** (343905) blue  
**NVX 343889** (343889) black

**ACTUAL SIZE** Make your selection by placing your used refill over the image.



PARKER

**A Parker**

**Rollerball Pen Refill**

Medium point. Sold by each.  
**PAR 1950324** (585471) blue  
**PAR 1950323** (585455) black



**A**



PARIS

**B Waterman**

**Rollerball Pen Refill**

Fine point. Sold by each.  
**WAT 1964018** (141648) blue  
**WAT 1964019** (141630) black



**B**



**C**



**C EnerGel® BLN75 Pen Refill**

0.5 mm needle point. Sold by each.  
**PEN LRN5-A** (777508) black  
**PEN LRN5-C** (777516) blue



**D**



**E**



**D EnerGel® BL77 Pen Refill**

Medium point. Gel ink. Sold by each.  
**0.7 mm**  
**PEN LR7-C** (697573) blue  
**PEN LR7-A** (697581) black  
**PEN LR7-B** (697565) red  
**PEN LR7-D** (412163) green  
**PEN LR7-V** (412189) violet  
**1.0 mm**  
**PENLR10-C** (555334) blue  
**PENLR10-A** (555326) black



**G**



**H**



**I**



**E EnerGel® BLP75 Pen Refill**

Permanent gel ink. 0.5 mm. Sold by each.  
**PEN LRP5-C** (587436) blue  
**PEN LRP5-A** (587428) black



**J**



**K**



**F Super Ink**

**Rollerball Refills**  
 Medium 0.7 mm point. Package of 2.  
**UBC1960654** (714170) blue  
**UBC1960653** (714162) black



**I G2 Rollerball Refills**

Refills for G2, Dr. Grip Ltd, B2P, G2 Stylus, GKnock rollerball pens.  
 Package of 2.

**Extra-fine point**  
**PIL 001343** (602136) blue  
**PIL 001336** (602110) black  
**Fine point**  
**PIL 001374** (602292) blue  
**PIL 001367** (602284) black  
**PIL 001381** (602300) red

MERANGUE

**K Universal Ink Cartridges**

Fits most fountain pens including Mont Blanc.  
 Package of 6. Black.  
**MGE 706523** (706523)



ZEBRA

**G Jimmie Gel Ballpoint Refill**

Refill for Jimmie Gel and J-Roller RX Gel. 0.7 mm.  
 Sold by each.  
**ZEB 84320** (606673) blue  
**ZEB 84310** (606665) black



**J Fountain Pen Ink Cartridges**

Water based ink. Fits in all Pilot fountain pens.  
 Box of 6.  
**PIL IC50-BL** (762534) blue  
**PIL IC50-BK** (762542) black



ZEBRA

**H Sarasa Gel Refill**

Gel ink. 0.7 mm. Refill for Sarasa, Sarasa Eco and GR8 Gel rolling ballpoint pen. Sold by each.  
**ZEB87020** (640854) blue  
**ZEB87010** (640847) black  
**ZEB87030** (640862) red



PARIS

**L Waterman® 50 Ml Ink Bottle**

50 ml. Sold by each.  
**WAT S0110720** (141507) serenity blue  
**WAT S0110710** (141515) intense black



**ACTUAL SIZE** Make your selection by placing your used refill over the image.



PARKER

## A Parker Ballpoint Pen Refill

Sold by each.

**Medium point**

PAR 1950371 (585430) blue

PAR 1950369 (585422) black

**Fine point**

PAR 1950368 (585406) blue

PAR 1950367 (585414) black



## B Waterman® Ballpoint Refill

Sold by each.

**Medium point**

WATS0944490 (141622) blue

WATS0944480 (141614) black

**Fine point**

WAT1964016 (141606) blue

WAT1964017 (141580) black



## C Power Tank Ballpoint Refills

Bold point, 1.0 mm. Package of 2. Blue.

UBC 1960516 (712323)



## D Signo 207 Impact Retractable Ballpoint Refills

Bold point, 1.0 mm. Package of 2.

UBC 65874PP (630459) blue

UBC 65873PP (630442) black



## E JetStream™ Ballpoint Refills

1.0 mm point. Package of 2.

UBC 35973 (757583) blue

UBC 35972 (757575) black



## F BP145 Ballpoint Refill

For Rexgrip, Dr. Grip. Sold by each.

**Medium point**

PILRFNSGGM-BE (630293) blue

PILRFNSGGM-BK (630285) black

**Fine point**

PILRFNSGGF-BE (630319) blue

PILRFNSGGF-BK (630301) black



## G BPS, BPSGP, BG-BPEGP, Super Grip G Ballpoint Refill

Oil-based Ink. Sold by each.

**0.7 mm point**

PILRFNGGF-BE (424671) blue

PILRFNGGF-BK (424689) black

**1.0 mm point**

PILRFNGGM-BE (829633) blue

PILRFNGGM-BK (829634) black



## H RSVP Ballpoint Pen Refills

0.7 mm point. Package of 2.

PEN BKL7-C (347690) blue

PEN BKL7-A (347682) black

PEN BKL7-B (555318) red

PENBKL7-V (1008507) violet



## I Acroball Ballpoint Refill

Oil-based Ink. Sold by each.

**Medium point**

PIL BRVF10M-BE (424713) blue

PIL BRVF10M-BK (424721) black

**Fine point**

PIL BRVF10F-BE (424705) blue

PIL BRVF10F-BK (424697) black



## J VR5/VR7 Rollerball Pen Refills

Package of 2.

**0.5 mm**

PIL VR5RL (777904) blue

PIL VR5RB (777896) black

PIL VR5RR (777912) red

**0.7 mm**

PIL VR7RL (777938) blue

PIL VR7RB (777920) black

PIL VR7RR (777946) red



## K Uni-Ball 207 Plus Gel Refills

0.7 mm. Package of 2.

UBC 70162 (832561) blue

UBC 70161 (832560) black



**A** Paper Mate



**B**  

**A ComfortMate Ultra® Mechanical Pencil**  
Ergonomic shape. Grooved rubberized grip. Chrome accents.  
**Sold by each**  
PAP 1738797 (778308) 0.5 mm  
PAP 1738798 (778316) 0.7 mm  
**Package of 2. Includes 12 HB leads and 5 eraser refills.**  
PAP 1738795 (782821) 0.5 mm  
PAP 2006829 (782839) 0.7 mm

**B BeGreen Progrex Mechanical Pencil**  
Rubberized grip for superior comfort. Sold by each.  
70% recycled content.  
**0.5 mm**  
PIL BGH125SLBE (128181) blue  
PIL BGH125SLBK (128199) black  
**0.7 mm**  
PIL BGH127SLBE (128207) blue  
PIL BGH127SLBK (128215) black



**C** 



**D** 

**C Super Grip Mechanical Pencil**  
Rubberized grip. 0.5 mm. Sold by each.  
PIL H185SL-BK (470658) black  
PIL H185SL-BE (470666) blue  
PIL212543 (665505) blue, tinted barrel

**D G2 Mechanical Pencil**  
Contoured rubberized grip. Sold by each. Black.  
PIL 276064 (670877) 0.5 mm  
PIL 276101 (670885) 0.7 mm  
• Eraser refills - package of 5  
PIL084362 (12138)

**E Ecolutions™ Mechanical Pencils**  
Made of 81% recycled plastic. 0.7 mm leads. Package of 12.  
Assorted colours.  
BICMPE12-BLK (832579)

**F Matic Grip Mechanical Pencils**  
Ergonomic rubber grip. 3 leads per pencil. Box of 12.  
Assorted colour barrels.  
BIC MPFG11 (307942) 0.5 mm  
BIC MPG11 (307884) 0.7 mm



**E**   



**F** 

**G Bic® Xtra-Comfort Mechanical Pencils**  
Mechanical pencil features a rubber grip for comfort and control. Each pencil includes 3 leads. 0.7 mm. Package of 5. Assorted colour barrels.  
BIC MPGP51 (594945)

**H Xtra-Life Mechanical Pencils**  
Box of 12. Assorted colour barrels.  
BIC MPF11 (660449) 0.5 mm  
BIC MP11 (660431) 0.7 mm



**G** 



**H** 

**A P-205/207/209 Mechanical Pencil**

Top selling automatic drafting pencil and the industry standard. Designed to meet the most critical demands of the professional or student. Fixed point. Sold by each.

**PEN P205-A** (223750) 0.5 mm (black)

**PEN P207-C** (422832) 0.7 mm (blue)

**PEN P209-G** (422840) 0.9 mm (yellow)



**B Twist-Erase Mechanical Pencil**

Rubberized grip. 0.5 mm. Sold by each.

**PEN QE515-A** (631622) black

**PEN QE515-C** (631630) blue

• Extra-long eraser refills - package of 3

**PENE10** (145466)

**C Energize™ Mechanical Pencil**

Grooved rubberized grip. Sold by each. 42% recycled content.

**PEN PL75-A** (751057) 0.5 mm

**PEN PL77-A** (751073) 0.7 mm

**D Heavy-Duty Mechanical Pencil**

Strong 1,3 mm lead. Marks on tile, wood, dry wood, concrete and paper.

Sturdy metal clip. Refill leads included. Sold by each.

**PEN AM13LBP** (829614)



**E Mars® Micro Mechanical Pencil**

Retractable. Rubberized grip. Sold by each. Blue.

**STD 775-05** (5769) 0.5 mm

**STD 775-07** (144972) 0.7 mm

**STD 775-09** (144998) 0.9 mm

**F Mars Technico Mechanical Pencil**

With metal clip, push-button and grip zone. Integrated lead sharpener in push-button. For 2.0 mm leads. HB. Sold by each.

**STD 780-BK** (340299)

**G Offix® Mechanical Pencil**

0.5 mm lead. Rubberized barrel. Sold by each.

**NVX 343715** (343715) black

**NVX 343723** (343723) blue

**H Offix® Recycled Mechanical Pencil**

Made of recycled resin. Rubberized grip. Sold by each.

**NVX 344002** (344002) 0.5 mm

**NVX 343996** (343996) 0.7 mm

**I Grip Mechanical Pencils**

Black barrel with coloured rubber grip and matching clip.

Latex-free eraser. Box of 12. Assorted colour barrels.

**ITA36152** (1006759) 0.5 mm

**ITA 36153** (1006766) 0.7 mm





**A** Pentel



**B** Pentel



**A Ain Stein Leads**

Ceramic cell structure is 10% stronger than other Pentel leads. 92% recycled content.

**0.5 mm - tube of 40 leads**

PEN C275-B (242024) B

PEN C275-HB (242040) HB

PEN C275-H (242032) H

**0.7 mm - tube of 40 leads**

PEN C277-B (242065) B

PEN C277-HB (242107) HB

PEN C277-H (242099) H

**0.9 mm - tube of 36 leads**

PENC279-HB (564153) HB

**B Super Hi-Polymer® Leads**

Ultra-resistant polymer leads. 75% recycled content.

**0.5 mm - tube of 12 leads**

PEN C505-2B (428664) 2B

PEN C505-HB (422790) HB

PENC505-2H (347740) 2H

**0.5 mm - tube of 15 leads**

PENC25-HB (223651) HB

**0.7 mm - tube of 12 leads**

PEN 50-2B (596650) 2B

PEN 50-B (596643) B

PEN50-HB (778324) HB

PEN50-H (347641) H

PEN50-2H (347633) 2H

**0.7 mm - tube of 30 leads**

PENC27-HB (665307) HB

**0.9 mm - tube of 15 leads**

PENC27-HB (102822) HB

**0.9 mm - tube of 30 leads**

PENC29BP-HB (753061) HB

**1.3 mm - tube of 12 leads**

PENCH13-HB (829615)



**C** PILOT



**D** PILOT

**C Eno-G 48-Lead Tube**

Extra strong polymer bonded fine leads.

**0.5 mm**

PIL PL5ENOG48B (480061) B

PIL PL5ENOG48 (474932) HB

PIL PL5ENOG48H (480079) H

**0.7 mm**

PIL PL7ENOG48 (728915) HB

**D Eno-G 12-Lead Tube**

Extra strong polymer bonded fine leads.

**0.5 mm**

PIL PL5ENOG-2B (213793) 2B

PIL PL5ENOG-B (12252) B

PIL PL5ENOG-HB (12286) HB

PIL PL5ENOG-2H (1230) 2H

PIL PL5ENOG-H (12278) H

**0.7 mm**

PIL PL7ENOG-B (12336) B

PIL PL7ENOG-HB (12351) HB

PIL PL7ENOG-H (12344) H



**E** offix



**F** Pentel



**E Offix® Pencil HB Leads**

Package of 3 tubes of 30 leads.

NVX357541 (357541) 0.5 mm

NVX357558 (357558) 0.7 mm

**F Eraser Refills**

13.8 mm x 4.25 mm. Package of 4.

PEN Z2-1N (555300)



**A Woodcase Pencils HB#2**

Made from real wood for easy sharpening. Ideal for schoolwork and general writing.  
**PAP7364022420** (565051) box 12  
**PAP7364022424** (316596) box 24



**A** Paper Mate

**B EverStrong™ Woodcase #2 Pencils**

Reinforced break-resistant lead. HB. Box of 12.  
**PAP 2047542** (584748)



**B** Paper Mate

**C Wopex® #2 Pencils**

Made from 100% recycled wood. Latex and PVC free eraser. Sharpened. HB. Box of 10.  
**STD 182-C10** (833006)



**C** STORECLERK



**E Economy Pencils**

Wood pencil. HB. Box of 12.  
**DIX 14402** (310862)

**F Ticonderoga® EnviroStick Pencils**

Made from reforested natural wood imprinted with certified non-toxic inks. Latex-free eraser. HB. Box of 12.  
**DIX 96201** (310508)

**G Ticonderoga® Tri-Write Pencils**

Triangular shaped wood pencil. HB. Box of 12.  
**DIX 13856** (310672)

**H Ticonderoga® Premium Pencils**

Wood pencil. Smooth satin finish. Latex-free eraser. Box of 12.  
**DIX 13882** (760769) HB

**I Offix® Pencils**

HB. High quality wood. Sharpened. Box of 12.  
**NVX343392** (343392)



**D** integra



**E** DIXON



**F** DIXON



**G** DIXON



**H** DIXON



**I** offix





**A** **DIXON®**



**B** **STÄDTLER**

**A Primary Printer Pencil**

Sold by each.  
**#1 very thick lead**  
**DIX 18997** (456392) red  
**#2 thick lead**  
**DIX18995** (456384) blue

**B Mars Lumograph Drawing Pencil**

Premium quality pencil for writing, drawing and sketching on paper. Extremely break-resistant. Wood from certified, sustainably managed forests. Sold by each.  
**STD 100-2B** (227538) 2B  
**STD 100-2H** (227546) 2H  
**STD 100-3B** (227553) 3B  
**STD100-3H** (4192) 3H  
**STD 100-4B** (227561) 4B  
**STD 100-4H** (227579) 4H  
**STD 100-6B** (227603) 6B  
**STD 100-6H** (227611) 6H  
**STD 100-B** (227496) B  
**STD 100-H** (227512) H  
**STD 100-HB** (227520) HB



**C** **STÄDTLER**



**D** **BUSINESS SOURCE®**

**C Norica® Pencils**

With latex-free eraser. Sharpened. Box of 12. FSC® certified.  
**STD 132462HC12** (736371) 2H  
**STD 132-46CB12** (718742) HB

**D Woodcase Pencils**

Rounded, hexagonal shape with eraser. #2 HB. Yellow.  
**BSN37507** (1051887) box of 12  
**BSN37508** (1051879) box of 72

**E Omnichrom Wooden Coloured Pencil**

For glossy and smooth surfaces. Easy to erase. Soft washable lead. Sold by each.  
**STD 108-0** (474254) white  
**STD 108-2** (474270) red  
**STD 108-3** (284992) blue  
**STD 108-9** (474296) black



**E** **STÄDTLER**



**F** **STABILO**

**F Stabilo-All® All-Surface Pencil**

Writes smoothly on wide range of surfaces. Perfect for writing on glass, acetate, plastic, metal and more. Water-soluble color wipes away from smooth surfaces. Sold by each.  
**SWS S0041** (1051820) blue  
**SWS S0040** (1051846) red  
**SWS S0052** (1051854) white

**G Golf Pencils**

Sharpened. HB graphite lead. 3-1/2 in. Box of 144. Yellow.  
**ITA 30980** (1006477)

**H Golf Pencils**

HB lead. 3-1/2 in length. Box of 144.  
**DIX14998** (125427)



**G** **integra.**



**H** **DIXON®**



# Correction Fluid and Erasers | Writing and Correction

## A Clic Eraser Holder

Ergonomic hold. Sold by each. Bleu.  
**PEN ZE22-C** (706929)  
 • Package of 2 refills  
**PEN ZER2** (180752)



## B Mars Plastic White Eraser

For paper and film. Latex-free. Sold by each.  
**STD 526-50UP** (227959)



## C Offix® White Vinyl Eraser

For paper and film. Sold by each.  
**NVX 343384** (343384)



## D Pink Pearl® Eraser

Soft, latex-free eraser. Sold by each.  
**DIX77003** (216911) #101 large  
**DIX 77006** (216978) #127 Pink-N-Ink

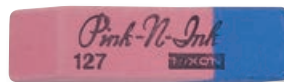

## E Pink Pencil Eraser

Medium. Sold by each.  
**ITA 36522** (1006394)



## F Pencil Cap Erasers

Wedge-shaped design. Fits all standard pencils. Box of 144.  
**ITA 36523** (1006345)

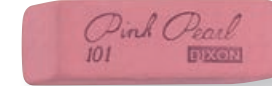

## G Correction Fluid

With sponge brush. Quick dry. Water-based. 22 ml. Package of 2.  
**PAP 56427WC** (829685)

## H Wite-Out® Quick Dry Correction Fluid

With foam applicator. 22 ml.  
**BIC WOFQDP2** (731661) pkg 2  
**BIC WOFQD12** (241331) box 12



## I Correction Pen

Metal tip. 12 ml. Sold by each. 37% recycled content.  
**PEN ZL31-W** (247817)

## J Universal Correction Fluid

Brush applicator. 20 ml. Sold by each.  
**DIX31900** (266791)



## K Multipurpose Correction Fluid

Brush applicator corrects errors on paper surfaces. Smooth application. Fast-drying. Sold by each.  
**ITA01539** (1006162)





**A Wite-Out® Ecolutions™ Mini Correction Tape**

Disposable. Single line. Protective cap. Strong and tear-resistant. 5 mm x 6 m. 56% recycled content.  
**BICWOET21-WHI** (823138) pkg 2  
**BIC WOET10-WHT** (829480) box 10

**B Wite-Out® Mini Correction Tape**

Strong and tear resistant. 5 mm x 8 m. Box of 12. Assorted colours.  
**BIC WOTM11-WHI** (832572)

**C Wite-Out® Mini Correction Tape**

Disposable. Stronger film-based tape. Flexible tip. With protective cap. 5 mm x 8 m. Sold by each.  
**BIC WOTMP11** (700781)

**D Wite-Out® EZcorrect® Correction Tape**

With protection cap. 4.2 mm x 12 m.  
**BIC WOTAPP11** (469668) by each  
**BICWOTAPP21** (128546) pkg 2  
**BIC WOTAPP31** (538686) pkg 3  
**BIC WOTAP10WHI** (428581) box 10

**E Wite-Out® Exact Liner™ Correction Tape**

Disposable. Stronger film-based tape, stronger. Comfortable grip. 5 mm x 6 m. Sold by each.  
**BIC WOELP11** (675223) by each  
**BIC832571** (832571) box 10

**F Correct-It® Correction Tape**

1 line. Disposable. 4.2 mm x 8.5 m. Sold by each.  
**PRI 2379352** (700799)

**G Begreen Whiteline Retractable Correction Tape**

Retractable and refillable. 4 mm x 6 m. Sold by each. 88% recycled content.  
**PIL BGECTE25K4** (778522)  
 • Refills - package of 2  
**PIL CRTR4GRBG** (790584)



Retractable and refillable



## A Dryline® Grip Correction Tape

Disposable. Rubberized grip. 5 mm x 8.5 m.  
**PAP 2006828** (833242) by each  
**PAP6915617** (228189) pkg 3  
**PAP06612** (290346) pkg 12



## B Left/Right Handed Correction Tape

180° swivel head. Single line. Disposable. 5 mm x 10 m. Sold by each.  
**GCI BCT-1158-C** (475616)

## C Dryline® Grip Recycled Correction Tape

Disposable. Rubberized grip. 5 mm x 8.5 m. Sold by each.  
 67% recycled content.  
**PAP 1744479** (795948)

## D Offix® Correction Tape

Disposable. 1 line. 5 mm x 8 m. Sold by each.  
**NVX343376** (343376)

## E Offix® Correction Tape

180° swivel head for left and right handed use. Single line.  
 Disposable. 5 mm x 8 m. Sold by each.  
**NVX345058** (345058)

## F Side-ApPLY Correction Tape

Single-line correction tape. Tear-resistant film resists breaking.  
 5 mm x 10 m. Package of 10.  
**ITA 60233** (1006261)

## G Value Correction Tape

Transparent case shows remaining tape. Non-refillable.  
 5 mm x 12 m. Package of 6.  
**ITA 60239** (1006287)

## H Post-It® Labelling and Cover-Up Tape

6 lines. Removable correction tape. Length 700 in. Sold by each.  
**MMM 658** (229450)





# BE BOLD

Enduraglide® Dry-Erase Markers by Quartet®



Three-chamber ink distribution system ensures constant ink flow



Quick-drying ink erases cleanly



See through barrel gauge indicates when ink level is low



Available in Chisel and Fine point



Delivers strong, bold colour every time that will not fade



Low odour and non-toxic

Conforms to ASTM D 4236



## EnduraGlide® Dry-Erase Markers

These markers use all available ink unlike traditional markers that waste 20% or more ink.

### Sold individually

QRT02888 (010-6447402888)	Chisel Tip Black	●	
QRT03964 (010-6447403964)	Chisel Tip Red	●	
QRT00165 (010-6447400165)	Chisel Tip Green	●	
QRT03963 (010-6447403963)	Chisel Tip Blue	●	

### Package of 4 colours

QRT03479 (010-3413803479)	Chisel Tip: Black, Red, Green, Blue	●●●●	
QRT03478 (010-3413803478)	Fine Tip: Black, Red, Green, Blue	●●●●	

### Package of 12 colours

QRT6447459961 (010-6447459961)	Chisel Tip: Black, Red, Green, Blue, 2 Pink, 2 Purple, 2 Teal, Neon Orange, Neon Green	●●●●●●●●●●●●	
--------------------------------	--	--------------	--

## EnduraGlide® Dry-Erase Marker Kit

Includes 4 markers in assorted colours, an eraser, and a pump spray cleaning solution for whiteboards.



### Accessory kit

QRT03922 (010-3413803922)	Chisel Tip: Black, Red, Green, Blue	●●●●	1.68 fl. Oz./47.8 ml
---------------------------	-------------------------------------	------	----------------------

## A 2 in 1 Fine Point Accessory Kit

Kit features dual tip markers with two bold colours in one marker. Lightweight eraser cleans thoroughly. Dry-erase cleaner. Marker tip colour combinations: black/orange; red/pink; blue/purple; green/lime. QRT 3413832101 (1008028)



## B Premium Glass Board Dry-Erase Markers

Bullet tip. Sold by each QRT 79553 (430439) black. Package of 4 QRT79552 (430447) assorted colours



Designed for glass boards

## C Dry Erase Marker

Non toxic. Low odor. Chisel point. Sold by each QRT 6447459967 (599480) black. QRT 6447459969 (546689) red. QRT 6447459968 (546671) blue. QRT 6447459970 (550772) green. Package of 4 QRT 6447459971 (546697) assorted colours



## D Dry Erase Whiteboard Markers

Non toxic. Low odour. Fine bullet point. Package of 4. Black. QRT 6447415858 (829482)



## E Begreen V Board Master Dry Erase Marker

Refillable whiteboard marker with a light resistant, bright liquid ink that allows for 10 meters visibility. Visible ink supply. Chisel point. 91% recycled content.

Sold by each PIL778191 (778191) black. PIL 778217 (778217) red. PIL 778183 (778183) blue. PIL 778209 (778209) green. PIL829635 (829635) orange. Package of 5 PIL 358388 (706945) Assorted colours. Ink cartridge refill PIL WBSVBM-BK (778241) black. PIL WBSVBM-RD (778266) red. PIL WBSVBM-BE (778233) blue. PIL WBSVBM-GN (778258) green. PILWBSVBM-OR (829636) orange



## F Maxiflo Dry Erase Marker

Re-ink push-button (push when colour fades). Liquid ink. Visible ink level. Chisel point.

Sold by each PENMWL6-A (606806) black. PENMWL6-B (606814) red. PENMWL6-C (606822) blue. PENMWL6-D (606830) green. Package of 4 PEN MWL6-4 (468645) assorted colours



## G Dry Erase Marker

Bullet point. Sold by each. PEN MW5-A (473538) black. PEN MW5-B (699876) red. PEN MW5-C (473546) blue. PEN MW5-D (564179) green



## H Wet Erase Markers

Writes on most non-porous surfaces, glass, plastic and metal. UV protected against fading. Non-toxic. ASTM D-4236 compliant. Chisel tip. Package of 4.

DEF SMA510V4WT (221747) white. DEF SMA510-V4 (221739) assorted colours

Writes on glass, plastic and metal



\*Do not use on whiteboards



**A** **EXPO**



**B** **EXPO**



**A Dry Erase Marker Set**

Includes 8 dry erase markers and 1 eraser. 2 markers are ultra thin tips, 2 are fine tips and 4 are chisel tips. Low odour ink. Assorted colours.  
**SAN 2171087** (829335)

**B Expo® Caddy Whiteboard Organizer**

Includes an organizer, 4 dry erase chisel tip markers and 1 eraser. Low odour. Assorted colours. 90% recycled content.  
**SAN 1785294** (165316)

**C 2 in 1 Dry Erase Markers**

2 ink colours in 1 marker. Low odour, chisel tip. Assorted colours.  
**SAN 1944655** (371476) pkg 4  
**SAN 1944658** (371484) pkg 8



**C** **EXPO**



**D** **EXPO**

**D Magnetic Dry Erase Markers**

Low odour. Marker sticks to magnetic surfaces. Eraser tip. Package of 4. Assorted colours.  
**SAN1944746** (429068) fine bullet  
**SAN 1944728** (429050) chisel

**E Expo® Neon™ Markers**

Write on black or white dry erase surfaces. Works on multiple non-porous surfaces (glass, windows, mirrors). Low odour. Bullet tip. Package of 5. Assorted colours.  
**SAN 1752226** (192526)



**E** **EXPO**



**F** **EXPO**

**F Expo® Dry Erase Whiteboard Marker**

Low odour. Bullet point.  
**Sold by each**  
**SAN 82001** (431684) black  
**SAN 82002** (431692) red  
**SAN 82003** (431700) blue  
**Package of 4**  
**SAN 82074** (1052026) assorted colours

**G Expo® Whiteboard Marker**

Dry erasable. Low Odour. Chisel point.  
**Sold by each**  
**SAN 80001** (389783) black  
**SAN 80002** (389791) red  
**SAN 80003** (389809) blue  
**SAN 1825973** (389817) green  
**SAN 80008** (598052) violet  
**Package of 4 (boxed)**  
**SAN1825974** (242412) assorted colours  
**Package of 4 (carded)**  
**SAN80174T** (114801) assorted - carded  
**Package of 12**  
**SAN80699** (778290) assorted  
**Box of 36**  
**SAN1920940** (1052034) black  
**SAN1921061** (425298) assorted colours



**G** **EXPO**



**H** **EXPO**

**H Dry Erase Fine Marker**

Specially formulated, alcohol-based ink with virtually no odour. Write on whiteboards, glass and most non-porous surfaces. Fine bullet tip.  
**Sold by each**  
**SAN86001** (389437) black  
**SAN86002** (389445) red  
**SAN86003** (389452) blue  
**Package of 4**  
**SAN 86674T** (586172) assorted colours  
**Package of 8**  
**SAN 86601** (548602) assorted colours  
**Package of 16**  
**SAN2138471** (828416) assorted colours  
**Box of 36**  
**SAN1921062** (574400) black



**I Dry Erase Ultra-Fine Markers**

Specially formulated, alcohol-based ink with virtually no odour. Write on whiteboards, glass and most non-porous surfaces. Ultra-fine bullet tip.  
**Package of 4**  
**SAN 1871133** (350595) assorted colours  
**Box of 12**  
**SAN 1871131** (350959) black  
**Box of 36**  
**SAN 2003894** (832701) black  
**SAN 2003895** (829684) assorted colours



**I** **EXPO**



## A Lumocolor® Correctable Marker

Non-permanent dry erase marker for sheet covers and white boards. Ink does not bleed through paper. Low odour.

**Sold by each**

**STD 305F9** (112219) 0.6 mm (black)

**STD 305F2** (548941) 0.6 mm (red)

**STD 305M9** (112235) 1.0 mm (black)

**Package of 4 - assorted colours**

**STD305FWP4-1** (276865) 0.6 mm

**STD305MWP4** (276873) 1.0 mm



A



## B Intensity Dry Erase Markers

Low odour. Rubberized grip. Assorted colours.

**Fine bullet tip**

**BICGELIPP41AS** (1008127) pkg 4

**Chisel tip**

**BIC GELITP41AS** (1008135) pkg 4

**BICGDEP61** (599258) pkg 6



B



## C Chalk Markers

Looks like chalk without the dust! Works on multiple non-porous surfaces including chalk boards, glass, car windows, mirrors, metal, plastic and ceramic. Non-toxic. Washable. Bullet tip. Package of 4. Assorted colours.

**EPI E152M** (595033)



C



## D Dry Erase Markers

For use on whiteboards and glass surfaces. Chisel tip.

**Package of 4**

**ITA30015** (1008085) assorted colours

**Package of 8**

**ITA33311** (1051978) assorted colours

**Box of 12**

**ITA30010** (1008093) black

**ITA33309** (1008101) red

**ITA33308** (1052018) blue

**ITA33310** (1008052) green



D



## E Pen Style Dry Erase Markers

For use on whiteboards and glass surfaces. Bullet tip.

**Package of 4**

**ITA01019** (1008077) assorted colours

**Box of 12**

**ITA01017** (1051986) black



E



## F Offix® Dry Erase Marker

Low odour. Chisel point.

**Sold by each**

**NVX343418** (343418) black

**NVX343426** (343426) red

**NVX343400** (343400) blue

**NVX343962** (343962) green

**Package of 4**

**NVX343970** (343970) assorted colours



F



## G Offix® Dry Erase Marker

Low odour. Bullet point.

**Sold by each**

**NVX343947** (343947) black

**Package of 4**

**NVX343939** (343939) assorted colours



G



Paper♥Mate®

Flair!

With  
Flair Pens,  
there's no limit  
to your fun.

Boost your  
writing  
FUN-FACTOR

Flair®  
**ULTRA FINE**



Flair®  
**MEDIUM**



Flair®  
**SCENTED**  
*Sunday Brunch*



Flair®  
**METALLIC**  
*City Lights*



Flair®  
**BOLD**



Products	Description
PAP 8330152	Paper Mate® Flair® Ultra Fine Tip, Black, 12 / box
PAP 2084302	Paper Mate® Flair® Ultra Fine Tip, Assorted, 12/pk

Products	Description
PAP 2027383	Paper Mate® Flair® Fine Tip, Assorted, 12/pk
PAP 2125407	Paper Mate® Flair® Scented, Sunday Brunch, 6/pk
PAP 2134319	Paper Mate® Flair® Metallic City Lights, 8/pk
PAP 2125411	Paper Mate® Flair® Bold Tip, 6/pk
PAP 2125414	Paper Mate® Flair® Bold Tip, 12/pk



## A Paper Mate Flair Scented Markers

Felt tip pens inspired by Sunday Brunch: Smell of sweet Sugared Grapefruit, rich Hazelnut Latte and even more! Package of 6. 0.7 mm medium point.  
**PAP 2125407** (828327)

## B Flair Candy POP Markers

Water-based ink that resists smudging and bleeding-through. Medium point. Package of 6. Candy colours.  
**PAP 1983602** (419945)

## C Flair® Marker

Reinforced felt point producing bold and expressive lines. Medium point. Sold by each.  
**PAP 1865459** (245118) black  
**PAP 1806703** (245027) red  
**PAP 1865460** (245126) blue  
**PAP 1806702** (245019) green  
**PAP 1806701** (245001) turquoise  
**PAP 1806704** (245035) purple



**A** Paper Mate®



**B** Paper Mate®

## D Ultra Fine Permanent Marker

Resilient ink dries quickly and resists both fading and water. Ultra-fine point.

**Sold by each**  
**SAN 37121** (194233) black  
**SAN 37002** (194241) red  
**SAN 37003** (194225) blue  
**Package of 5**  
**SAN 37665PP** (548487) black  
**SAN 37675PP** (319228) assorted colours  
**Package of 12**  
**SAN37001** (564823) black  
**SAN37175PP** (564856) assorted colours



**C** Paper Mate®



**D** Sharpie®



## E Twin Tip Permanent Marker

Fine and ultra fine tips in one marker. Resilient ink dries quickly and resists both fading and water.

**Sold by each**  
**SAN32001** (606764) black  
**SAN 32002** (606772) red  
**SAN32203** (606780) blue  
**Package of 4**  
**SAN32174PP** (319210) assorted colours



**E** Sharpie®



**F** Sharpie®



## F Retractable Ultra-Fine Marker

Resilient ink dries quickly and resists both fading and water. Ultra-fine tip.

**SAN 1735790** (789313) black  
**SAN 1735791** (789321) red  
**SAN 1735792** (789339) blue

## G Retractable Permanent Marker

Resilient ink dries quickly and resists both fading and water. Fine tip.

**Sold by each**  
**SAN 32701** (716514) black  
**SAN 32702** (716522) red  
**Package of 3**  
**SAN 32726PP** (319194) assorted colours  
**Package of 8**  
**SAN32730PP** (828415) assorted colours



**G** Sharpie®



**H** PILOT



## H Fineliner Permanent Marker

Quick drying water based liquid ink. Durable polyester tip. 0.4 mm.

**Sold by each**  
**PIL 085949** (213850) black  
**PIL 085956** (12492) red  
**PIL 085963** (213843) blue  
**PIL 085970** (12468) green  
**Package of 4**  
**PILSWPP-4** (782433) assorted colours



**A** Sharpie®



**B** Sharpie®



**A Sharpie® Permanent Markers**

Marks on most surfaces. Includes 5 each fine and ultra-fine markers. Package of 10. Assorted colours. **SAN 2168860** (829679)

**B Sharpie® Fine Marker**

Resilient ink dries quickly and resists both fading and water. Fine point.

**Sold by each**

- SAN30001** (194191) black
- SAN30002** (194209) red
- SAN30003** (194217) blue
- SAN30004** (194183) green
- SAN30006** (234450) orange
- SAN30008** (232850) purple

**Package of 3**

**SAN 30173PP** (564922) assorted colours

**Package of 8**

**SAN 30078** (778159) assorted colours

**Package of 12**

**SAN 30075PP** (234575) assorted colours

**Package of 24**

**SAN 1927350** (371617) assorted colours

**Box of 36**

**SAN1884739** (279661) black

**SAN1921559** (425280) assorted colours



**C** Sharpie®



**D** Sharpie®

**C Super Permanent Marker**

Resilient ink dries quickly and resists both fading and water.

Large ink supply. Large bullet point. Sold by each.

**SAN 33001** (455857) black

**SAN 33002** (455873) red

**D Sharpie Neon Markers**

Vivid colour in natural light and turn fluorescent in black light.

Fine point. Package of 5. Assorted colours.

**SAN1860443** (218081)



**E** Sharpie®



**F** BIC®



**E Metallic Marker**

Great for dark surfaces. Authentic metallic finish in opaque, permanent ink. No shaking required. Fine point.

**Sold by each**

**SAN1823887** (1007434) gold

**SAN 39100** (692020) silver

**Package of 3**

**SAN1823815** (218073) gold/bronze/silver

**F Ecolutions™ Permanent Markers**

Permanent ink marks on most surfaces. Package of 12. Bullet tip.

Assorted colours: black, blue, red and green. Made of 51% recycled plastic.

**BICPMER12-BLK** (832580)



**G** BIC®



**H** Pentel®

**G Intensity® Permanent Markers**

Won't dry out if the cap is left off for up to two weeks. Acid-free.

Rubberized grip. Fine point. Black.

**BICGPM11BK** (241406) box 12

**BICGPM241BLK** (349761) box 24

**H N50 Permanent Marker**

Bullet tip. Metal body. 4.3 mm. Sold by each. Black.

**PEN N50-A** (313361)



**I** PILOT®



**J** STAEDTLER®



**J Lumocolor® 60 Permanent Markers**

Includes different markers for various applications. Pack of 4.

**Lumocolor 236-1, 319 GM M-9, 314-9, and 348-9**

**STD 60-BK-5** (833013)

**Lumocolor 313-9, 319 LM F-9, 317-9, and 350-9**

**STD 60-BK-6** (833014)

## A Lumocolor® Permanent Marker

Dry-Safe ink. Can be left uncapped for days without drying up. Can be used on CD/DVDs. 39% recycled content.

### Super fine (0.4 mm)

- STD 313-9 (182733) black
- STD 313-2 (342923) red
- STD 313-3 (48629) blue
- STD313-5 (347864) green
- STD313WP4 (227710) 4 colours

### Fine (0.6 mm)

- STD318-9 (183319) black
- STD 318-2 (182766) red
- STD 318-3 (183301) blue
- STD 318-5 (185710) green
- STD318WP4 (272864) 4 colours
- STD318WP8 (48868) 8 colours

### Medium (1.0 mm)

- STD 317-9 (182758) black
- STD 317-2 (182741) red
- STD 317-3 (184424) blue
- STD 317-5 (185702) green
- STD317WP4 (227827) 4 colours
- STD317WP8 (4226) 8 colours
- Chisel (2.5 mm)
- STD 314-9 (184390) black



## B Lumocolor® Permanent Marker for Special Surfaces

Permanent ink designed for most special surfaces. Sold by each. Black. 39% recycled content.

- STD 319S-9 (699637) super fine
- STD 319F-9 (699629) fine
- STD 319M-9 (788489) medium



## C Triplus® Fineliner Marker

Dry-Safe ink. Can be uncapped without drying. For fatigue-free writing. Triangular body. 0.3 mm point. 46% recycled content.

### Sold by each

- STD 334-9 (672683) black
- STD 334-2 (672659) red
- STD 334-3 (672667) blue
- STD 334-5 (672675) green

### Package of 10

- STD 334SB10A6 (705202) assorted colours

### Package of 20

- STD 334SB20A6 (103226) assorted colours



## D Lumocolor® Permanent Multipurpose Marker

Dry-Safe ink. Can be left uncapped for days without drying up. High intensity colours. Low odour. Chisel point. Sold by each. 39% recycled content.

- STD 350-9 (455931) black
- STD 350-2 (455956) red
- STD 350-3 (766824) blue



## E Offix® Permanent Marker

Low odour. Fine point. Sold by each.

- NVX 343442 (343442) black
- NVX 343459 (343459) red
- NVX 343434 (343434) blue

## F Offix® Permanent Marker

Low odour. Bullet point. Sold by each. Black.

- NVX343954 (343954)

## G Permanent Fine Point Markers

Strong tip. Quick-drying. Permanent on most surfaces. Fade-resistant and water-resistant. Box of 12.

- ITA 30016 (1007467) black
- ITA30018 (1007483) red
- ITA30017 (1007475) blue



## H Flip Chart Markers

Bullet point. For conference pad. Ink does not bleed through paper. Assorted colours.

- SAN 22474 (194522) pkg 4
- SAN22480PP (829507) pkg 8



**A** Sharpie®



**B** Sharpie®

**A Permanent Sharpie® Marker Set**

Includes 2 fine, 2 ultra-fine, and 2 chisel-tip black Sharpie® permanent markers. Package of 6. Black.  
**SAN 2135318** (823815)

**B Sharpie® Metallic Markers**

Great for dark surfaces. Authentic metallic finish in opaque, permanent ink. No shaking required. Chisel point. Package of 3. Bronze, gold, silver.  
**SAN 2089609** (599233)

**C Sharpie® Permanent Marker**

Chisel point allows for broad and fine lines. Permanent ink marks on most surfaces. Resilient ink dries quickly and resists both fading and water; AP certified.

**Sold by each**  
**SAN 38281** (228932) black  
**SAN 38283** (228965) red  
**SAN 38282** (228940) blue

**Package of 4**  
**SAN 38264PP** (155598) black  
**SAN 38254PP** (155580) assorted colours

**Box of 12**  
**SAN 38201** (564948) black  
**SAN 38202** (242180) red  
**SAN 38203** (242198) blue



**C** Sharpie®



**D** PILOT



**D 400 Permanent Markers**

Ink will not dry out if left without cap for a day. Chisel tip. Box of 12.  
**PIL SCA400-BK** (371393) black  
**PIL SCA400-RD** (371401) red  
**PIL SCA400-BE** (371385) blue  
**PIL SCA400-GN** (587857) green

**E Permanent Eco-Marker**

Chisel point. Waterproof and xylene free. Instant drying. Refillable. Sold by each.

**Large size**  
**JIF JK90-BK** (1007186) black  
**JIFJK90-RD** (554519) red  
**JIF JK90-BL** (1007194) blue  
**King size**  
**JIF JK100-BK** (554501) black



**E** JIFFCO



**F** AVERY



**F Marks-a-Lot® Permanent Marker**

Chisel point. Comfortable grip. Water-resistant, smear-proof. Writes on any surface. Non-toxic. PVC free. Sold by each. Black.

**Regular size**  
**AVEC84201** (1438) without clip  
**AVEC86201** (14506) with clip  
**Large size**  
**AVE C86211** (262972) without clip

**G Integra Permanent Markers**

Chisel Point. Waterproof, smear-proof.

**Package of 4**  
**ITA30012** (1007153) assorted colours  
**Box of 12**  
**ITA30011** (1007327) black  
**ITA33328** (1007450) red  
**ITA33327** (1007442) blue



**G** integra.



**H** offix.



**H Offix® Permanent Marker**

Low odour. Chisel point. Sold by each.

**NVX343475** (343475) black  
**NVX343483** (343483) red  
**NVX343467** (343467) blue

## A Sharpie® Pro Permanent Marker

For use on metal, wood, PVC and concrete. Formulated to mark on wet, oily, dusty and abrasive surfaces. Grip on cap for easy access even with gloves. Anti-roll barrel shape.

Sold by each - black

SAN 2018501 (587444) fine point

SAN 2018505 (587469) chisel point

SAN2018510 (587451) XL chisel point

Package of 2 - black/red

SAN 2018333 (828881) chisel point

Package of 4 - black/red/blue

SAN 2018324 (829551) fine point



A Sharpie.



B Sharpie.



## C King Size™ Permanent Marker

Industrial strength. Aluminum barrel and felt tip stand up to heavy use. Marks on wet and oily surfaces, wood, metal, foil, stone, plastic, leather, etc. Sold by each. Black.

SAN 1943572 (234443)

## D Magnum® Permanent Markers

Chisel point. Line width up to 1/2 in. Box of 12. Black.

SAN1945533 (242206)

## E Extreme Permanent Markers

Resist fading when exposed to UV rays, rain, snow and mud.

Box of 12. Black.

SAN 1927432 (350926)

## F Industrial Permanent Marker

Resistant to chemicals, light, and heat up to 500°F. Writes on glass, metal, greasy parts. For industrial use. Fine point. Black.

SAN 1943576 (739011) each

SAN 2003898 (829682) box 36



C Sharpie.

D Sharpie.



## G Redimark® Permanent Marker

Writes on all surfaces. Stays permanent under extreme conditions. Non-toxic. Chisel point. Sold by each.

DIX 87170 (634642) black

DIX 87110 (310698) red

## H Refillable Super Color Marker

Permanent chisel tip for industrial usage. Marks on most surfaces. Xylene free. Sold by each.

PIL 095429 (12419) black

PIL 095443 (213827) blue

PIL 095436 (213835) red

• Ink refill - 30 ml bottle

PIL088292 (145235) black

PIL088308 (119644) red

PIL088315 (145227) blue



E Sharpie.



F Sharpie.



G DIXON



H PILOT





**A** *Sharpie*



**B** *PILOT*



**A Paint Marker**

Permanent oil-based paint marker. For metal, pottery, wood, rubber, glass, plastic and more. Quick-drying ink is resistant to water, fading and abrasion. Non-toxic. Sold by each.

**Extra-fine tip**

- SAN 35532 (103036) gold
- SAN35531 (387696) white
- SAN 35533 (103044) silver

**Fine tip**

- SAN35539 (1008283) yellow
- SAN35544 (1008267) gold
- SAN35545 (1008275) silver
- SAN35543 (387712) white

**Medium tip**

- SAN 35559 (103051) gold
- SAN35560 (103069) silver
- SAN 35558 (319368) white
- SAN 35551 (516963) blue
- SAN 35550 (319384) red
- SAN 35554 (319376) yellow

**Bold tip**

- SAN35564 (1008250) black
- SAN 35568 (103077) white



**C** *Pentel*



**D** *JIFFCO*



**B Super Color Permanent Marker**

Quick drying brilliant, metallic paint marks permanently on most surfaces including plastic, glass, wood, coated paper and metal. Acrylic fiber tip. Sold by each.

**Extra-fine point**

- PIL 087967 (145169) gold
- PIL 087950 (145177) silver
- PIL 087974 (275669) white

**Large chisel point**

- PILSCG (145185) gold
- PILSBR (145193) silver
- PILSCP-BE (275677) white

**C White 100W S Paint Marker**

Oil-base ink. Bullet point. Sold by each. White opaque ink.

- PENX100W-S (145219) fine
- PEN X100W-M (532143) medium
- PENX100-W (313254) large

**D Artline Paint Marker**

Permanent paint marker. Completely opaque even on dark or transparent surfaces. For indoor or outdoor use all types of surfaces. Sold by each.

**0.8 mm**

- JIFEK444-BK (1008408) black
- JIFEK444-WT (1008416) white

**1.2 mm**

- JIFEK440-BK (1008341) black
- JIF EK440-WT (547729) white

**2.3 mm**

- JIF EK400-BK (456418) black
- JIF EK400-WT (456434) white
- JIF EK400-BL (456483) blue
- JIF EK400-RD (456475) red
- JIF EK400-GN (456491) green
- JIFEK400-BN (1008359) brown
- JIF EK400-YW (456509) yellow
- JIFEK400-LB (1008366) light blue
- JIFEK400-OG (1008374) orange
- JIFEK400-PK (1008382) pink
- JIFEK400-PL (1008390) purple



**E** *DIXON*



**F** *DIXON*



**F Lumber Crayon**

For wood. Water resistant. Sold by each.

- DIX 49400 (16170) black
- DIX 49600 (215251) yellow
- DIX 52000 (16196) red

**E China Marker**

Clean bold stroke on most porous and non-porous surface including glass, plastic, metal and rubber. Sold by each.

- DIX 00092 (310805) white
- DIX 00071 (310755) crimson red
- DIX 00073 (310763) yellow
- DIX 00074 (310771) green
- DIX 00077 (310813) black
- DIX 00079 (310789) red
- DIX 00080 (310797) blue



## A Retractable Highlighters

Smear Guard® ink technology. Certified AP nontoxic. Chisel point.

Package of 5

SAN 1740822 (139923) yellow

Package of 8

SAN 28101 (139931) assorted colours

Box of 12

SAN28025 (423244) yellow



**A** Sharpie.

## B Liquid Highlighter

Liquid ink. Visible ink level. Quick-drying and odourless. Non-toxic.

Sold by each

SAN 1754463 (194142) yellow

Package of 5

SAN 24575PP (338335) assorted colours

Package of 10

SAN 24415PP (319160) assorted colours

Box of 12

SAN1754464 (372326) pink

SAN1754466 (372334) orange

SAN1754468 (372359) green

SAN1754467 (372342) blue

SAN1754469 (372367) purple



**B** Sharpie.

## C FriXion® Light Erasable Highlighter

Thermo-sensitive gel ink disappears with erasing friction coming from the rubber tip. Chisel tip. Vibrant fluorescent colours.

Sold by each

PIL 375132 (106203) yellow

PIL 375118 (106195) pink

PIL 375125 (598037) orange

PIL 375149 (106187) green

PIL 375156 (598045) blue

PIL 375163 (598029) violet

Package of 3

PILSWFL-S3 (112029) assorted colours

Package of 6

PIL375248 (112037) assorted colours



**C** PILOT

Erasable

## D FriXion® Light Highlighters

Thermo-sensitive gel ink disappears with erasing friction coming from the rubber tip. Chisel tip. Package of 6. Assorted pastel colours.

PILSWFL-S6S (815755)

## E 24/7 Highlighter

Multi-purpose highlighter with free-flowing ink. Chisel tip highlights thick or thin lines. Won't bleed through most papers. Sold by each.

PEN SL12-G (596544) yellow

PEN SL12-P (596536) pink

PEN SL12-F (596569) orange

PEN SL12-K (596528) green

PEN SL12-S (596577) blue

PEN SL12-V (596551) purple



**E** Pentel.

## F Offix® Highlighter

Liquid ink. Fine chisel point. Visible ink level. Sold by each.

NVX343533 (343533) yellow

NVX343517 (343517) pink

NVX343509 (343509) orange

NVX343491 (343491) green

NVX343525 (343525) blue



**F** offix.

## G Liquid Highlighters

Visible ink level. Chisel tip.

Package of 5

ITA30000 (1007962) assorted colours

Box of 12

ITA30006 (1007970) yellow

ITA33312 (1007780) pink

ITA33313 (1007764) orange

ITA33314 (1007757) green

ITA33315 (1007772) purple



**G** integra.



**A** Sharpie.



**B** Sharpie.



**A Clear View Highlighters**

See-through chisel tip. Smear-Guard® ink. Package of 12. Assorted colours.

**SAN2149296** (828331)

**B Pastel Highlighters**

Smear-Guard® ink. Rubberized grip. Package of 6. Assorted colours.

**SAN 2157486** (829676)

**C Pocket Highlighters**

Smear-Guard® ink. Narrow chisel tip.

**Package of 4**  
**SAN 27174PP** (564963) assorted colours

**Box of 12**  
**SAN27025** (564955) yellow  
**SAN 27009** (372383) pink

**SAN 27006** (372375) orange

**SAN 27026** (372391) green

**Box of 36**  
**SAN2003991** (832699) yellow  
**SAN2133497** (832570) assorted colours

**D Brite Liner® Grip Highlighters**

Fluorescent ink. Rubberized grip.

**Standard colours - package of 5**  
**BICGBLP51-AST** (135624) assorted colours

**Pastel colours - box of 12**  
**BICGBLD11-AST** (832573) assorted colours

**E Brite Liner® Pocket Highlighters**

Chisel tip for broad-line highlighting or fine-line underlining. Non-toxic.

**Box of 12**  
**BICBL11-YW** (219592) yellow

**Box of 24**  
**BIC BL241-YEL** (572800) yellow  
**BIC BL241-AST** (572818) assorted colours

**F Spotlinter® Highlighter**

Chisel tip. Convenient pocket clip. Vibrant fluorescent colours.

**Sold by each**  
**PIL 086199** (12542) yellow  
**PIL 086205** (12534) pink  
**PIL 086182** (12526) orange  
**PIL SWSL-GN** (12518) green  
**PIL 086151** (5702) blue  
**PIL 086175** (129973) purple

**Package of 6**  
**PILSWSL-S6** (389049) assorted colours

**G Integra Highlighters**

Pen style. Chisel tip makes wide or narrow lines. Ink is quick-drying and odourless.

**Package of 5**  
**ITA36180** (1007798) assorted colours

**Box of 12**  
**ITA36181** (1007848) yellow

**ITA36183** (1007830) pink

**ITA36182** (1007822) orange

**ITA36185** (1007814) green

**ITA36184** (1007806) blue

**H Offix® Highlighter**

Pen style. Chisel tip.

**NVX343681** (343681) yellow

**NVX343707** (343707) pink

**NVX343699** (343699) orange

**NVX343657** (343657) green

**NVX343665** (343665) blue

**Package of 5**  
**NVX343640** (343640) assorted colours



**C** Sharpie.



**D** BIC.



**E** BIC.



**F** PILOT.



**G** integra.



**H** offix.



## A Clear View® Highlighters

See-through tip eliminates blind spots for precise highlighting. Clear cap. No smear. Chisel tip. Box of 12. Yellow. SAN1897847 (556225)

## B Illumina Highlighter

Fast drying fluorescent ink. Suitable for copies and fax. Sold by each.

**PEN SL60G-G** (428870) yellow  
**PEN SL60P-P** (428888) pink  
**PEN SL60F-F** (428912) orange  
**PEN SL60K-K** (428904) green  
**PEN SL60S-S** (428896) blue

## C Textsurfer® Classic Highlighter

For all types of paper. Does not smudge inkjet print-outs. Turquoise and purple colours remain clearly visible on photocopies. Sold by each. 25% recycled content.

**STD 364-1** (194456) yellow  
**STD 364-23** (194464) pink  
**STD 364-4** (194449) orange  
**STD 364-5** (194472) green  
**STD 364-3** (194498) blue  
**STD 364-6** (471763) purple  
**STD 364-2** (134916) red  
**STD 364-35** (699009) turquoise

## D Pastel Highlighters

Smear Guard ink. Chisel point for both wide and narrow lines of text. Package of 6. Assorted Colours. SAN 2157488 (829677)

## E Tank Highlighter

Smear Guard ink. Chisel point for both wide and narrow lines of text.

**Sold by each**  
**SAN25005** (565127) yellow  
**SAN25034** (194167) fluorescent yellow  
**Box of 12**  
**SAN25025** (565010) yellow  
**SAN 25009** (242743) pink  
**SAN 25006** (242115) orange  
**SAN 25026** (242149) green  
**SAN 25010** (242131) blue  
**Box of 36**  
**SAN 1920938** (572578) yellow

## F Desk Style Hi-Liter®

For standard paper. Chisel point. PVC free. Fluo colours.

**Sold by each**  
**AVE C83507** (243873) yellow  
**AVE C83509** (243865) pink  
**AVE C83506** (243857) orange  
**AVE C83504** (243840) green  
**AVE C83503** (242248) blue  
**AVE 24060** (778043) purple  
**Package of 4**  
**AVEC83564** (334680) assorted colours  
**Package of 12**  
**AVE78881** (155515) assorted colours

## G Offix® Highlighter

Chisel point.

**Sold by each**  
**NVX343632** (343632) yellow  
**NVX343624** (343624) pink  
**NVX343566** (343566) orange  
**NVX343558** (343558) green  
**NVX343541** (343541) blue  
**Package of 5**  
**NVX343673** (343673) assorted colours

## H Integra Highlighters

Fluorescent ink stays bright and resists fading. Chisel tip.

**Package of 6**  
**ITA30001** (1007947) assorted colours  
**Box of 12**  
**1007955** (1007955) yellow  
**1007715** (1007715) pink  
**1007699** (1007699) orange  
**1007681** (1007681) green  
**1007673** (1007673) blue  
**1007707** (1007707) purple



**A** Sharpie.



**B** Pentel.



**C** Textsurfer.



**D** Sharpie.



**E** Sharpie.



**F** Avery.



**G** Offix.



**H** Integra.

# It's all about the journey.

Whether its traditional drawing, DIY crafts or fine art projects - start your creative explorations here with STAEDTLER.



STAEDTLER®

Head of ideas.



STD3345B20A6



STD1278CC24A6



STD12781C24A6



STD3200TB36



STD8023-C24-1

Oven-bake modeling clay



**A Liquid Tempera**

Ready-to-use. Washes easily from skin. Non-separating. Freeze-thaw stable. AP certified. Non-toxic.

- 946 ml
- DIX 10901 (184838) red
- DIX 10902 (184846) orange
- DIX 10903 (184853) yellow
- DIX 10904 (184861) green
- DIX 10905 (184879) blue
- DIX 10906 (184887) violet
- DIX 10907 (184895) white
- DIX 10908 (184903) brown
- DIX 10909 (184911) black
- DIX 10910 (184929) magenta
- DIX 10911 (184937) peach
- DIX 10912 (184945) turquoise

- 3.78 litres
- DIX 10601 (184689) red
- DIX 10602 (184705) orange
- DIX 10603 (184747) yellow
- DIX 10604 (184713) green
- DIX 10605 (184754) blue
- DIX 10606 (184762) violet
- DIX 10607 (184770) white
- DIX 10608 (184788) brown
- DIX 10609 (184796) black
- DIX 10610 (184804) magenta
- DIX 10611 (184812) peach
- DIX 10613 (184820) turquoise



**B Liquid Tempera Paint Set**

Nontoxic, washable paint in jars is made with the finest pigments. Translucent laydown lets paper show through for added brightness. One brush included. Conforms to ASTM standards. 25 ml each. Package of 8. Assorted colours.

DIX 10768 (1003855)



**C Tempera Paint Cakes**

Brush on any surface. Non-toxic. 9 assorted colours.

DIX PAC9834 (833368)



**D Washable Fingerprint**

No spill. Non-toxic. Squeeze bottles. 236 ml. Package of 3. Yellow, blue, red.

CYO 55-0355 (277343)



**E Smock**

With front pockets. Water-resistant and washable.

Blue

GCI G18900BE (518498) age 4

GCI G18901BE (518514) age 6

GCI G18902BE (518530) age 10

Pink

GCI G18900PK (518480) age 4

GCI G18901PK (518506) age 6

GCI G18902PK (518522) age 10





**A Washable Paint**

Cleans up with soap and water. Washes easily from skin and most clothing. 3.79 L.

- CYO 5421289038** (832605) red
  - CYO 5421289036** (832604) orange
  - CYO 5421289034** (832603) yellow
  - CYO 5421289044** (832608) green
  - CYO 5421289042** (832607) blue
  - CYO 5421289040** (832606) violet
  - CYO 5421289053** (832611) white
  - CYO 5421289007** (832601) brown
  - CYO 5421289051** (832610) black
  - CYO 5421289069** (832612) magenta
  - CYO 5421289033** (832602) peach
  - CYO 5421289048** (832609) turquoise
- **Paint dispensing pump**  
**CYO54-2129** (832613)

**B Kids Washable Paint**

59 ml bottles. Assorted colours.

- CYO 54-1216** (440461) glitter (box 6)
- CYO 54-1215** (440479) neon (box 10)



**C Paint Sticks**

Quick drying paint sticks. Package of 6. Assorted colours.  
**CYO 54-0487** (1000637)

**D Fabric Paint**

Liquid paint is suitable for detailed designs. The paint is for creating designs on t-shirts, bags, and other fabrics. Package of 12. Assorted colours.

- PEN FFPC1-12** (829616)

**E Acrylic Paint Set**

Enabled for drawing on various materials such as paper, canvas, metal, glass, plastic and paper clay etc. It's waterproof after the paint dries. Used for pastose painting, but can also be diluted with water to resemble watercolours. Tube of 28 ml. 12 colours.  
**PENWA2-12** (828316)



**F Acrylic Paint Tube Set**

Easy to blend and mix with smooth consistency. Highly pigmented. Colours are water soluble prior to drying. After drying, paint is waterproof and fade resistant. Can be used on a wide variety of surfaces. 12 ml tubes. Assorted colours.

- STD 8500-C1202** (1066258) pkg 12
- STD 8500-C2402** (1066265) pkg 24

**G Painting Canvas**

Canvas stretched on wooden frame with 1.5 cm think edge. Doesn't need to be framed and can easily be hung. Ideal for oil and acrylic painting. Package of 2. White.

- DIX D515030810** (833094) 8 x 10 in.
- DIX D515031620** (833095) 16 x 20 in.



## A Washable Watercolours

Paint brush included. Package of 24. Assorted colours.  
**CYO 53-2400** (159392)



**A**



## B Washable Pop & Paint™ Watercolour Palette

Includes 96 watercolour chips, palette, cleaning sponge, and refillable water brush. Assorted colours.  
**CYO 54-6251** (832595)



**B**



## C Paint Stampers

Includes three 25 ml. washable neon paint bottles, 3 nozzles, 3 connectors, 8 stamps, 5 white paper sheets and 5 black paper sheets. Non-toxic.  
**CYO 54-6250** (832594)



**C**



## D Washable Watercolour Paint Set

Semi-moist for long-lasting colour. Brush included. Certified AP non-toxic. Assorted colours.  
**DIX16016** (1003862) pkg 16



**D**



## E Oval Watercolour Paint Set

Semi-moist for long-lasting colour. Certified AP Nontoxic. Brush included. Extra-deep pans can easily be replaced by refills. 5.09 ml. Package of 8. Assorted colours.  
**DIX00800** (1003847)



**E**



## F Watercolour Paint Palette Set

Washable formula cleans up easily with water. Colours blend easily to create high-quality works of art. Mixing tray incorporated into the lid. Paint brush included. Designed for use on watercolor paper or board. 7.5 ml tube of zinc white included. Package of 12. Assorted colours.  
**STD 888-C12-A6** (1066588)



**F**



## G Watercolour Paint Tubes

Washable formula cleans up easily with water. Brilliant and intense colours. Easy to blend. 12 tubes of 12ml. Assorted colours.  
**STD 8880-C1202** (1066596)



## H Watercolour Paint Tubes

This paint dries evenly, resists fading and will not flake. Each laminated tube contains 5 ml of brilliant, acid-free watercolour paint. Package of 12. Assorted colours.  
**PEN WFRS-12** (1066570)



## I Oil Paint Set

Suitable for all types of painting surfaces. Perfect for users of all skill levels. 12 ml each. Package of 12. Assorted colours.  
**DIX 118500100** (1003912)





**A** **DERWENT**



**B** **SELECTUM**



**C** **SELECTUM**

**N**  
2023

**A Artists Brushes**

Assortment of brushes for different painting techniques. All-natural fiber bristles are tightly embedded for clean strokes. Sturdy wood handles offer excellent grip for easy control. Assorted sizes.

**DWT 98250** (1003961) package of 3  
**DWT 98238** (1003954) package of 8

**B Synthetic Brush Set**

Excellent elasticity and form retention. Durable and easy to clean. For watercolour, acrylic, tempera, oil and water-soluble pencils. Includes brush round no.2, round no.8 and flat no.8. Package of 3.  
**STD989-BK3-A6** (556951)

**C Water Brush**

The brush allows you to draw, write or paint. Water fillable for watercolours and painting.

**STD 949-BK-1-C** (833011)

**D Brush Set**

High quality bristles, large wood handles and seamless metal ferrules that prevent paint build-up. Non-toxic. Variety of sizes and shapes. Package of 5.

**DIX 94005** (595025)

**E Brushes**

High quality. Various head shapes. Package of 5. Assorted colours.

**CYO 05-3506** (159384)

**F Flat Brushes**

Crisp edge and broad strokes. Variety of sizes. Package of 4.

**CYO 05-3618** (372573)

**G Assorted Brushes Set**

Assortment of 3 types of brushes for various uses. Easy to hold and handle. Includes 12 brushes of each style. Giant brush: natural bristles and plastic handle. Big flat brush and big round brush: white synthetic bristles and wooden handle. Box of 36.

**CYO 05-0036** (832596)

**H Round Brushes**

Chubby brush with medium round tip. Assorted coloured plastic handle. 75 mm.

**LPR SL53771** (833338)

**I Artist Sponge Brushes**

Wood handle. 1 in. sponge size. Package of 6.

**LPR SL36391** (833105)

**J Paint pots**

Stackable plastic containers. With lids. 1.75 x 2.10 x 1.62 in. H. Package of 3. Assorted colours.

**LPR SL54598** (833337)

**K Paint Palette**

**LPRSL54077** (516435)



**D** **PRANG**



**E** **Crayola**



**F** **Crayola**



**G** **Crayola**

**N**  
2023



**H** **Selectum**

**N**  
2023



**I** **Selectum**

**N**  
2023



**J** **Selectum**

**N**  
2023



**K** **Selectum**



## A Model Magic Modeling Clay

Non-toxic. Soft, lightweight and easy to use. Air dries in 24 hours.  
907 g. Box of 4.  
**CYO 57-4400** (613620) white  
**CYO57-4415** (829509) primary colours



## B Modeling Clay

1.13 kg. White.  
**CYO 57-5051** (426189)

## C Modeling Clay

Easy molding and sculpting. Made of non-drying, non-hardening modeling materials. Non-toxic. Scrapes easily off most surfaces for easy cleanup. 453 g. Package of 4 individually wrapped colours: red, yellow, blue and green.  
**CYO 57-0304** (1004027)



## D Modeling Clay Jumbo Pack

Clay will not harden or dry out. Each 4 oz. stick is individually wrapped. Non-toxic. Package of 8. Assorted colours: red, blue, green, yellow, brown, black, orange, white.  
**CYO 57-0315** (832597)

## E FIMO Modeling Clay

24 blocks of oven-hardening modeling clay. 600g. Assorted colours.  
**STD8023-C24-1** (833010)



## F DAS® Modeling Clay

Air-hardening. Smooth, even, easy texture. Once the clay has dried (usually within 24 hours), the solid model can be varnished or painted.  
**White**  
**DIX 387000** (572008) 1.1lb (0.5 kg)  
**DIX 387500** (184952) 2.2 lb (1 kg)  
**Terracotta**  
**DIX387100** (1004019) 1.1lb (0.5 kg)  
**DIX387600** (184960) 2.2 lb (1 kg)

## G Modeling Clay

Non-hardening, pliable clay shapes easily. 454 g.  
**DIX 00781** (184531) red  
**DIX 00782** (184549) orange  
**DIX 00783** (184556) yellow  
**DIX 00784** (184564) green  
**DIX 00785** (184572) blue  
**DIX 00786** (184606) violet  
**DIX 00787** (184630) white  
**DIX 00788** (184648) brown  
**DIX 00789** (184655) black  
**DIX 00790** (184663) grey  
**DIX 00791** (218230) pink



## H Play Dough Accessories

Package of 5.  
**LPRSL18020** (574426)

## I Modeling Clay Moulds

Assorted shapes and sizes. 24 pieces. Assorted colours.  
**LPR SL18873** (833104)

## J Plastic Pencil Box

8.4 x 5.6 x 2.5 in. Assorted colours.  
**STX 61605B125** (781724)

## K Pencil Box

Durable plastic. Opaque lid. Clear bottom. Assorted colours.  
**STX61620U12C** (339424) 13,5 x 5,6 x 2,5 in.  
**STX61632U12C** (339432) 11,2 x 7,8 x 4,4 in.

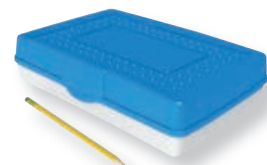



**A Funny Mat® Colouring Mat**

Colour with water-based paint or felt-tip pens, wash, then re-colour many times. Made from polypropylene. Non-toxic. 48 x 33.5 cm.  
**FNM ALPHABET** (732792) alphabet  
**FNM DEEPSEA** (829549) ocean  
**FNM 829550** (829550) firefighters  
**FNM JURASSIC** (581454) dinosaurs  
**FNM NUMBERS-M** (581447) numbers  
**FNM PRINCESS** (581462) princess  
**FNM SPACE** (829548) space

**B Funny Mat® Colouring Mat**

Colour with washable wax pens or chalk, wash, then re-colour many times. Made from polypropylene. Non-toxic. 40 x 40 cm. Black.  
**FNM 829546** (829546) north pole  
**FNM OCEANS-B** (829543) ocean  
**FNM SAFARI-B** (829544) safari  
**FNM SPACE-B** (829545) space



**C FriXion® Erasable Colouring Markers**

FriXion® lets you write, erase, re-write. Thermo-sensitive water-based ink disappears with erasing friction coming from the rubber tip. Quick drying ink that won't bleed through paper. 2.5 mm tip. Assorted colours.

**PIL SWFCS6** (181370) pkg 6  
**PILSWFCS12** (181362) pkg 12



**D Unicorn Sidewalk Chalk**

Includes 3 unicorn horn sidewalk chalk sticks. Can be washed with water. Nontoxic. Assorted colours.  
**CY051-3749** (832600)

**E Washable Sidewalk Chalk**

Package of 24. Assorted colours.  
**CY0 51-3556** (246959)

**F Sidewalk Chalk**

Plastic box with handle. 20 jumbo size chalk. Assorted colours.  
**LPR SL54247** (833106)



**G Giant Colouring Roll**

Easy to fold, tear and share. Deep sea friends designs. 15 perforated pages. 30 x 44 cm.  
**CY0 04-1792** (832697)

**H Face and Body Paint**

Easy to apply and remove. Includes a brush and sponge. 6 tubes.  
**AVDC01136** (573774) primary colours  
**AVDC01143** (573782) adventure colours

**I Gue Premade Slime**

Ready to play with right out of its slime container. Non-toxic. 118.25 ml.  
**EPI 2149166** (828335) cosmic shimmer  
**EPI 2149167** (828336) fruity slushie



## A Feathers

Package of 20. Assorted colours.  
**LPR SL54451** (516443)



**A** **Selectum**

## B Pom-Poms

Assorted colours.  
**LPR SL54481** (833333) 1/2 in. pack of 85  
**LPR SL54438** (833334) 1 in. pack of 100  
**LPR SL54482** (833107) assorted sizes, pack of 70



**B** **Selectum**

## C Round Beads

With 1 m string. Package of 35 g. Assorted colours.  
**LPR SL54523** (516450)



**C** **Selectum**

## D Wood Craft Sticks

4.5 in. Package of 100.  
**LPR SL54951** (833331) natural wood  
**LPR SL54950** (833330) assorted colours



**D** **Selectum**

## E Pipe Cleaners

4 mm thickness. Package of 100.  
**LPR SL53312** (833336) standard colours  
**LPR SL53311** (833335) brite colours



**C** **Selectum**

## F Jiggly Eyes

Set of small round eyes in assorted sizes  
 (5 mm, 7 mm, 10 mm, 15 mm et 20 mm). Black and white.  
**LPR SL54800** (833332)



**D** **Selectum**

## G Felt Sheets

9 x 12 in. Package of 10. Assorted colours.  
**LPR 54-610** (182626)



**E** **Selectum**

## H Premium Hot Glue Pen

Non-stick tip for easy glue clean-up. Includes two all-purpose glue sticks. Can be used on plastic, felt, styrofoam, paper, and silk. 2 year limited warranty.  
**ACM 16761** (573667)  
 • Glue sticks  
**ACM16837** (1032953) 7 mm. Package of 30.

**F** **Selectum**

## I Mini Hot Glue Gun

Solid state electronics. Trigger feed. Great for arts & crafts, hobbyists & do it yourselfers.  
**BOS GR10** (226522)  
 • Glue sticks  
**BOS GS10DT** (226555) 8 mm. Package of 24

**E** **Selectum**

## J Dual Temperature Glue Gun

Non-drip nozzle. High/low temperature. Built-in safety stand. Great for fabrics, ceramics, hobbies, wood.  
**BOS GR20** (226548)  
 • Glue sticks  
**BOS GS20DT** (226563) 12 mm. Package of 24

**F** **Selectum**



**G** **Selectum**



**H** **WESTCOTT**  
 Depuis 1872 Since 1872



**I** **STANLEY**



**J** **STANLEY**

<p><b>A</b> </p> 	<p><b>B</b> </p> 	<p><b>A All Purpose White Glue</b> LEP393889 (218826) 150 ml LEP531252 (27284) 3 L</p> <p><b>B Washable White Glue</b> Non-toxic. 950 ml. EPI6155060331 (573287) 950 ml</p>
<p><b>C</b> </p> 	<p><b>D</b> </p> 	<p><b>C School Glue Stick</b> LEP668409 (671479) 10 g LEP665171 (671487) 20 g LEP646239 (671495) 40 g</p> <p><b>D Rubber Cement</b> Provides a solution for adhering photos and detailed cut and paste projects. Brush on applicator. Acid-free and photo safe. 118 ml. EPIE64425 (347567)</p>
 <p><b>E</b> </p>		<p><b>E Coloured Duck Tape</b> Ideal for arts and crafts. Tears easily by hand without curling. <b>48 mm x 9.1 m</b> DUC 280748 (226860) gold <b>48 mm x 13.71 m</b> DUC 1265016 (232785) fluo pink DUC 1265019 (226969) neon orange DUC 1304968 (1003631) neon green</p> <p><b>F Kidi Cut Preschool Scissors</b> Ideal for initiation to cutting. Fiberglass blades that do not cut hair or clothes and do not conduct electricity. Assorted colours. MAP 378146 (440438)</p>
<p><b>F</b> </p> 	<p><b>G</b> </p> 	<p><b>G Kids Ray-X Scissors</b> Microban® antimicrobial protection. Assorted colours. <b>Rounded tips</b> ACM 14596X (266114) 5 in. <b>Pointed tips</b> ACM14597X (372292) 5 in. ACM 14608X (781278) 6 in.</p> <p><b>H School Scissors</b> 6 in. Semi-pointed tips. Stainless steel blades. Plastic handles. 10 year warranty. ACM 11127 (122424) left-handed (green) ACM 11128 (210591) right-handed</p>
<p><b>H</b> </p> 	<p><b>I</b> </p> 	<p><b>J</b> </p> 

## A Geosign Vinyl Letters and Numbers

Weatherproof self-adhesive vinyl. Helvetica.

### Black upper case letters

- USS 31811 (143685) 12 mm (1/2 in.)
- USS 31911 (143602) 19 mm (3/4 in.)
- USS31111 (143529) 25 mm (1 in.)
- USS31211 (143248) 50 mm (2 in.)
- USS31311 (143164) 75 mm (3 in.)
- USS32411 (531681) 100 mm (4 in.)
- USS 32611 (142661) 150 mm (6 in.)

### Black numbers

- USS31831 (143560) 12 mm (1/2 in.)
- USS31131 (143446) 25 mm (1 in.)
- USS 31231 (143289) 50 mm (2 in.)
- USS31331 (143206) 75 mm (3 in.)
- USS 32431 (142612) 100 mm (4 in.)
- USS32621 (1066729) 150 mm (6 in.)

### Black numbers, upper and lower case letters

- USS31741 (143644) 6 mm (1/4 in.)

### White numbers, upper and lower case letters

- USS31112 (143537) 25 mm (1 in.)
- USS 31212 (143255) 50 mm (2 in.)



## B Letter Stencils

Individual letters, numbers and symbols on resistant cardboard tiles.

- USS 101 (191346) 25 mm (1 in.)
- USS 102 (191353) 50 mm (2 in.)
- USS103 (191361) 75 mm (3 in.)
- USS 104 (191379) 100 mm (4 in.)
- USS 106 (191395) 150 mm (6 in.)



## C Adhesive Letters and Numbers

These permanent vinyl peel and stick characters are great for use on mailboxes, windows or vehicles. Waterproof. Black on white.

- USS 2570 (563619) 1 in.
- USS 2571 (563627) 2 in.

## D EZ Art Repositionable Letters and Numbers

Peel & stick. Repositionable. Won't stretch or tear. PVC free. 1 and 2 in. letters and numbers. 172 characters. Miscellaneous symbols included. White.

- USS 6189 (1074517)



## E EZ Art™ Peel & Stick Sheets

Peel-and-stick design transfers images from computer to poster board. Repositionable adhesive holds on strong while allowing easy updates. Compatible with most laser and ink jet printers. 8.5 x 11 in. Package of 6.

- USS 6097 (1066695)



## F Art Tape

Use on charts, graphs, signs, directories, and more. Ideal for indoor or outdoor use. Use on glass, wood, metal, plastic, paper, and more. Black.

- USS73161 (774158) 1/16 x 600 in.
- USS73081 (774141) 1/8 x 320 in.
- USS 73041 (774133) 1/4 x 320 in.

## G Foam Letters and Numbers

Adhesive. Package of 5 g. Assorted colours.

- LPR SL54554 (574418)



## H Lettering Stencils

Letters and numbers. Great for signs, posters, school projects, scrapbooks. Shatterproof plastic. 4 different sizes: 1-1/4, 3/4, 1/2 and 1/4 in.

- STD 978-455 (833012)

## I Art & Drafting Template

Includes circles, squares, hexagons and triangles templates. Built-in risers to reduce smudged lines plus allow easy pickup and repositioning. Made of translucent, nonglare, smoke gray flexible plastic for a long-lasting use.

- CHA 10361 (1004266) 5-3/4 x 11 x 0.3 in.
- CHA 1002PI (1004259) 5-7/8 x 10 x 0.3 in.

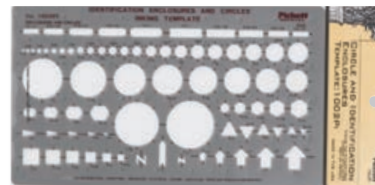



**A** *Hilroy*



**B** *Hilroy*

**A FunTime Construction Paper**

9 x 12 in. Assorted colours.  
**HLR 41002** (249524) 96 sheets  
**HLR 41016** (249375) 200 sheets

**B FunTime® Scrapbook**

This scrapbook features newsprint pages and sturdy tape binding to prevent pages from falling out. 14-7/8 x 10-7/8 in. 36 sheets.  
**HLR 26590** (531491)

**C FunTime® Fingerpaint Pad**

Specially coated paper designed for finger paints as well as poster paints. 18 x 12 in. Package of 30 sheets. White.  
**HLR 41801** (249409)



**C** *Hilroy*



**D** *Crayola*

**D Crayola Construction Paper**

Great for home and school projects. Package of 120 sheets. 10 assorted colours. Certified PEFC.  
**CY061-2005** (1004316)

**E Black Construction Paper**

Construction paper is sturdy and durable. Holds its shape when folded, glued and stapled into all kinds of 3D creations. 9 x 12 in. Package of 40 sheets. Black.  
**CY0 61-8831** (832590)

**F Construction Paper**

Comes in a reusable plastic envelope. 8-1/4 x 11-5/8 in. Assorted colours.  
**GCI49850** (747212) 50 sheets  
**GCI49810** (223198) 100 sheets



**E** *Crayola*



**F** *GEO*

**G Kids 'N' Krafts Fingerpaint Pad**

Specially coated wax paper designed for finger paints as well as poster paints. 18 x 12 in. Package of 15 sheets. White.  
**NPP R1812-1830** (579896)

**H Clearprint Isometric Grid Paper Pad**

30 degrees isometric grid. Ideal for plumbing, heating and air conditioning, and mechanical design layouts. Helps in scaling drawings in 3 main direction. Letter size. 8.5 x 11 in. Package of 30 sheets. White.  
**CLE 932811ISO** (1059055)

**I Clearprint Design Vellum Pad**

Smooth white surface is suitable for pencil and ink. The vellum pad is produced without solvents to meet EPA requirements. Acid-free. 50 sheets.  
**CLE 10001410** (1045948) 8.5 x 11 in.  
**CLE 10001416** (1045930) 11 x 17 in.



**G** *NA Paper Incorporated*



**H** *Chartpak*



**I** *Chartpak*

## A Construction Paper

Individual colours. Chlorine-free. Package of 48, 9 x 12 in.

- NPP 1405-102** (433185) orange
  - NPP 1405-104** (433011) yellow
  - NPP 1405-108** (433193) dark blue
  - NPP 1405-109** (433029) purple
  - NPP 1405-110** (594309) white
  - NPP 1405-111** (594317) grey
  - NPP 1405-114** (433078) pink
  - NPP 1405-117** (433367) red
  - NPP 1405-124** (433136) emerald green
  - NPP 1405-126** (433086) sky blue
  - NPP 1405-132** (433110) brown
  - NPP 1405-135** (433219) black
  - NPP 1405-138** (433037) assorted colours
- 12 x 18 in.
- NPP 1406-102** (433094) orange
  - NPP 1406-104** (433052) yellow
  - NPP 1406-108** (433201) dark blue
  - NPP 1406-109** (433268) purple
  - NPP 1406-110** (433227) white
  - NPP 1406-111** (588806) grey
  - NPP 1406-114** (433128) pink
  - NPP 1406-117** (433243) red
  - NPP 1406-124** (433177) emerald green
  - NPP 1406-126** (433334) sky blue
  - NPP 1406-132** (594291) brown
  - NPP 1406-135** (433060) black
  - NPP 1406-138** (433045) assorted colours

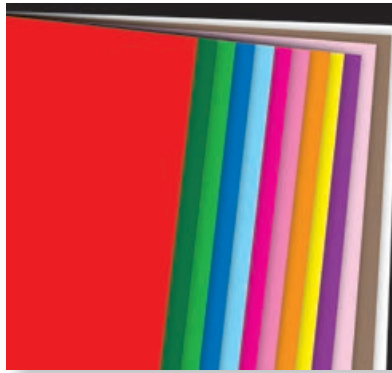

**A**  North American Paper Incorporated



**B** 



## B 4-Ply Colour Cardstock

Ideal for art projects, stenciling and posters. 14 pt. thickness. Coloured on both sides. Reclosable storage carton. 22 x 28 in. 10 assorted colours. Package of 50. 100% recycled, 55% post-consumer content.

**DIX P0076347** (833362)



## C White Cardstock

Colour index. 220M. 22-1/2 x 35 po. Sold by each. FSC® certified.

**VTV152668** (761163)

## D Cartridge Paper

Toothy surface. Perfect for pencil, charcoal, pastel. Package of 96 sheets. Bright white.

- NPP C1601-090** (432708) 23 x 30.5 cm
- NPP C1602-090** (432807) 30 x 45.7 cm
- NPP C1603-090** (432823) 45.7 x 61 cm

## E Newsprint Paper

Inexpensive drawing paper suitable for pencil or charcoal. 9 x 12 in. Box of 480 sheets.

**NPP C0701-110** (433565)

**C** 



**D**  North American Paper Incorporated

## F Colour Cardstock

Bristol. 2-ply. 22 x 28 in. Box of 48.

- NPP C0248-135** (828053) black
- NPP C0248-102** (828045) orange
- NPP C0248-104** (828046) yellow
- NPP C0248-106** (828047) light green
- NPP C0248-110** (828048) white
- NPP C0248-117** (828049) red
- NPP C0248-125** (828050) dark green
- NPP C0248-126** (828051) light blue
- NPP C0248-129** (828052) magenta



4 ply cardstock also available online



**E**  North American Paper Incorporated

**F**  North American Paper Incorporated





**A** *Hilroy*



**B** **Bienfang**

**A Studio Pro® Watercolour Book**

For working with various wet media techniques. Pad format. White paper. Acid-free. 90 lb. 15 sheets. 9 x 12 in.  
HLR 41526 (249508)

**B Watercolour Book**

For working with watercolor and mixed media. Pad format. White paper. Acid-free. 90 lb. 15 sheets.  
SBA R285621 (1052596) 9 x 12 in.  
SBA R285631 (1052588) 11 x 15 in.

**C Studio Pro® Drawing Book**

For use with various dry media, pens and inks. Pad format. White paper. Acid-free. 50 lb. 50 sheets.  
HLR 41516 (249482) 9 x 12 in.  
HLR 41518 (249490) 11 x 14 in.



**C** *Hilroy*



**D** **Bienfang**

**D Drawing Pad**

Spiral binding. Each sheet can be used with any dry medium. Perfect for mechanical and graphite pencils. White paper. Acid-free. 55 lb. 50 sheets. 9 x 12 in.  
SBA R230721 (1052555)

**E Studio Pro® Poly Sketch Book**

Polypropylene. Twin-wire. Ideal for sketching with charcoals, pastels and pencil media. White paper. Acid-free. 70 lb. 75 sheets.  
HLR 41520 (1045956) 8.5 x 11 in.  
HLR 41012 (249367) 9 x 6 in.  
HLR 41500 (249417) 12 x 9 in.



**E** *Hilroy*

**F Sketch Book**

Spiral bound for easy-turning pages. Medium surface texture paper which is perfect for all your charcoal, pastel, pencil, pen and ink drawing and sketching projects. Acid-free. 50 lb. 100 sheets.  
SBA R237104 (1052513) 5.5 x 8.5 in.  
SBA R237117 (1052521) 8.5 x 11 in.

**G Studio® Sketch Book**

Smooth cartridge paper. Perforated edge. Spiral binding. 9 x 12 in. 30 sheets. White.  
HLR 41511 (419358)

**H Studio® Scrap Book**

Durable paper. Spiral binding.  
HLR 26421 (32128) 12 x 10 in. 30 sheets  
HLR 26411 (255786) 14 x 11 in. 20 sheets



**F** **Bienfang**



**G** *Hilroy*

**I Marker Pad**

Perfect for professionals and beginning artists. Smooth surface is suitable for markers and felt tip pens. Acid-free. 9 x 12 in. 40 sheets. White paper.  
SBA 220001 (1052471)



**H** *Hilroy*



**I** **Bienfang**



## A Mi-Teintes® Pastel Paper

Dual-surfaced paper offers versatility. Recommended for watercolor, gouache, acrylic work, and silk screen purposes. Assorted colours 98 lb. 24 sheets. 9 x 12 in.  
**DIX 100510864** (1045963)



**A** **CANSON**

## B XL Palette Paper

Palette paper offers a convenient alternative to a traditional palette, sparing you the tedious task of cleaning it with solvent. Smooth coated surface to allow mixtures of paints (oil or acrylic). 9 x 12 in. 40 sheets.  
**DIX 100510953** (1074483)



**B** **CANSON**

## C Parchment Tracing Paper Pad

Lightweight and see-through. Perfect for rough sketches, drawings, overlays and more. Designed for use with pencil, pen, markers, charcoal and pastel. 50 sheets.  
**SBA 240121** (1052299) 9 x 12 in.  
**SBA 240142** (1052281) 14 x 17 in.



**C** **Bienfang**

## D Parchment Tracing Paper Roll

High translucency makes tracing smooth and accurate. Perfect for rough sketches, drawings, overlays and more. Designed for use with pencil, pen, markers, charcoal and pastel. 24 lb. White.  
**SBA 240321** (1052562) 18 x 720 in.  
**SBA 240323** (1052570) 24 x 720 in.



**D** **Bienfang**

## E Tracing Paper Roll

Fine-texture paper delivers clean, consistent results. Versatile design works with pencils, inks and markers. Made for architects, designers and engineers. White paper. 8 lb.  
**SBA 340138** (1052539) 24 x 1800 in.  
**SBA 340140** (1052547) 36 x 1800 in.

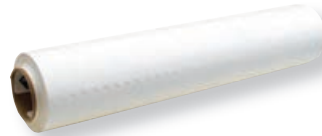

**E** **Bienfang**

## F Colour and Erase™ Reusable Mat

Includes reusable mat, 4 washable markers, wipe cloth and refillable eraser. 81 x 58 cm.  
**CYO 04-4145** (832592)



**F** **Crayola**



## G Art and Photo Archival Presentation Book

Polypropylene. Each page includes an acid-free, archival quality black backing paper insert. 24 pages (48 viewing sides). Black.  
**VLB 97840** (1066299) 8.5 x 11 in.  
**VLB 97810** (1066273) 11 x 17 in.

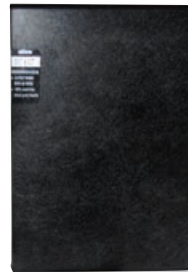

**G** **vlb**

## H Carry All Tote Case

Polypropylene. Resists water and tearing. Zipper closure keeps the contents secure. Perfect for organizing artwork, supplies, files and more. Black.  
**VLB 34080** (1066315) 18 x 4 x 15 in.  
**VLB 34050** (1066323) 25 x 4 x 18 in.  
**VLB 34060** (1066331) 27 x 4 x 21 in.



**H** **vlb**

## I Telescopic Tube

Plastic tube which protects documents from bending and against fading from exposure to sunlight. 3 in diameter. Length of tub adjustable from 28 to 49 in. With shoulder strap.  
**STD 94872/124** (667139)



**I** **STÄDTLER**

## J Tradition Faux Leather Photo Album

3-ring. Mock-leather. 400 photos. 4 x 6 in. Black.  
**NVX 00144X** (127159)



**J** **Kangaroo**



**A Soft Pastel Chalks**

Soft chalk smudges easily and can layer multiple times. Highly break-resistant. Rich in pigmentation and smooth in texture. Paper wrapping keeps your fingers clean during use. Water-soluble. Assorted colours.

**STD 2430-C12A6** (1066555) pkg 12  
**STD 2430-C24A6** (1066562) pkg 24

**B Oil Pastels**

Pastels are medium soft and easy to blend. They are highly break-resistant and waterproof. Perfect for sketching and illustrating. Certified AP non-toxic. Assorted colours.

**STD2420-C1207** (1066513) pkg 12  
**STD 2420-C2407** (1066105) pkg 24

**C Oil Pastels Set**

Brilliant coloured pastels. Acid-free. More resistant to the effects of humidity for longer-lasting drawings. Assorted colours.

**PEN XPHN-12C** (278077) box 12  
**PEN PHN-16** (1066521) box 16  
**PEN PHN-25** (594960) box 25  
**PEN PHN-36** (1066539) pkg 36

**D Metallic Watercolour Crayons**

Highly opaque colours, easy to blend. To be used with brush and water to obtain a variety of shades and/or colour mixes. Paper sleeve keeps hands clean. Box of 12. Assorted colours.

**STD 223MC12** (833008)

**E Watercolour Pencils**

Just add water. Triangular shape. 3 mm. Box of 24.

**STD12781C24A6** (833009)

**F Arts® Watercolour Pencils**

Colour wood pencils. Suitable for most types of papers, as well as silk, cotton and wood. Assorted colours.

**PEN CB9-12** (584045) box 12  
**PEN CB9-24** (584037) box 24



## A Scholar™ Manga Drawing Set

Includes graphite pencils ranging from light to dark, 2 coloured erasable pencils, 2 markers with bullet and brush tips, an eraser. Includes a tips and techniques brochure.

SAN 1822417 (333971)



## B Mars Lumograph Drawing Pencils

Premium quality pencils for writing, drawing and sketching on paper. Extremely break-resistant. Wood from certified, sustainably managed forests.

Set of 6 pencils

STD 100G6 (471920) 8B, 7B, 6B, 4B, 2B, HB

Set of 12 pencils

STD 100G12 (103192)

6B, 5B, 4B, 3B, 2B, H, HB, F, H, 2H, 3H, 4H



## C Kneadable Art Eraser

Specially designed for use with soft pastel chalks, soft graphite pencils and charcoal or for cleaning artwork or film. Package of 2. Grey.

STD 5427 (1006337)

## D Premier® Colouring Pencil

Perfect for layering, blending, and shading. Great for both beginners and professionals. Sold by each.

SAN 3375 (8789) silver

SAN 3346 (213330) canary yellow

SAN 3353 (8532) crimson red

SAN 3363 (8649) black

SAN 3365 (8672) white



## E Scholar™ Wooden Colouring Pencils

Pre-sharpened. Assorted colours.

SAN 92804 (290148) box of 12

SAN 92805 (290155) box of 24

SAN 92808HT (290189) box of 60



## F Verithin Wooden Marking Pencils

These high quality pencils make edges cleaner, outlines bolder and lettering pristine. Extremely fine point. Assorted colours.

SAN 2427 (1051713) pkg 24

SAN 2428 (1051721) pkg 36



## G Pencil Case

2 compartments. Half-moon shape. 22.5 x 12 x 12 cm. Grey and black.

GCI LG22219BK (833521)

## H Pencil Case

2 compartments. Large flap opening. Carrying handle. 7.8 x 5.1 x 6.3 in.

GCI F22200GY (828226) grey

GCI F22200BE (828224) blue

GCI F22200BK (828225) black

GCI F22200PK (828227) pink





**A Wood Colouring Pencils**

Pre-sharpened. Non-toxic. Assorted colours.  
**CY067-2012** (469114) box of 12  
**Colors of Kindness**  
**CYO 67-6196** (832696) box of 12  
**Sharpener included**  
**CYO 67-2024** (469122) box of 24  
**Colors of the World**  
**CY067-4154** (815796) box of 24  
**Metallic pencils**  
**CYO 67-2060** (635763) box of 60

**B Colouring Pencils**

High-quality coloured pencil in classic triangular shape. Assorted colours.  
**STD1278-C12** (806679) box of 12  
**STD1278CC24A6** (832569) box of 24

**C Easy-Grip Colouring Pencils**

Pre-sharpened. The hexagonal shape makes them easier to grip. The extra-thick tip makes them sturdier. Nontoxic. Assorted bright and bold colours. Package of 8.  
**CYO 80-1344** (832591)



**D Colouring Pencils**

Pre-sharpened. Non-toxic. 3.3 mm lead. Assorted colours.  
**DIX 22120** (537001) box of 12  
**DIX 22240** (132373) box of 24  
**DIX22480** (594085) box of 50

**E Groove Wooden Colouring Pencils**

Slim and triangular. Break-proof 3.3 mm lead. Box of 24. Assorted colours.  
**DIX28124** (275883)



**F Classpack® Colouring Pencils**

Box of 240. 12 bright, assorted colours.  
**CYO 68-8024** (425819)



**G Ultra-Clean™ Wax Crayons**

Thick point. Washable. Assorted colours.  
**CYO 52-3280** (431197) box of 8  
**CYO 52-3281** (833097) box of 16



**H Dry-Erase Crayons**

With erase cloth and built-in sharpener. No caps, no smell. Simply remove stubborn markers with water. Package of 8. Assorted colours.  
**CYO 98-8658** (425884)



**A Wax Crayons**

Non-toxic. Assorted colours.  
**CYO 52-0008** (266486) box 8  
**CYO 52-0016** (129874) box 16  
**CYO 52-0024** (266478) box 24

**B Colors of the World Wax Crayons**

Assorted colours to represent the skin colour of people around the world. Box of 24.  
**CYO52-1733** (815762)

**C Tripod Grip Crayons**

The triangular barrels are designed to fit nicely in toddler hands and promote proper writing grip. Washable. Nontoxic. Assorted colours. Package of 8.  
**CYO 80-6868** (832587)

**D Palm Grasp Crayons**

These 3 egg-shaped crayons are easy-to-grip for toddlers. Washable. Nontoxic. Red, yellow and blue. 12 months +.  
**CYO 80-6905** (833098)

**E Mini-Twistables Wax Crayons**

Package of 24. Neon colours.  
**CYO52-9724** (724658)

**F Twistables Wax Crayons**

Box of 12. Assorted colours.  
**CYO52-4512** (653063)

**G Decor Multi-Surface Markers**

Water-based ink to use on multi-surfaces as cardboard, wood, glass, leather, plastic, modeling clay. Non-toxic. Assorted glitter colours. Package of 8.  
**DIX 74008** (595009)

**H Decor Glass Crayons**

Wax crayons perfect for drawing on glass, mirrors and more. The colour can easily be removed with a damp cloth. AP Certified non-toxic. Box of 10. Assorted colours.  
**DIX74010** (1007384)

**I Window Writers Markers**

Broad tip. Washable. Package of 10. Assorted colours.  
**CYO 56-9704** (425793)





**A** PRISMACOLOR®



**B** Schneider



**A Premier Fine Line Markers**

Acid-free, archival quality. Package of 5 : 0.005 mm, 0.1 mm, 0.3 mm, 0.5 mm, 0.8 mm. Black.  
**SAN 14171** (375782)

**B Pictus Markers**

Ideal writing instrument for drawing, sketching, illustrating and writing as well as for working with stencils. Water-based pigmented ink which resist to fading. Line thickness : 0.3 mm, 0.5 mm, 0.7 mm, Package of 3. Black.  
**PSY197593** (829647)

**C Sharpie® Marker**

Ideal for notetaking, letter writing and card making. Precise, consistent line width. Durable and smudge resistant ink. Won't bleed through paper. Fine point.

**Sold by each**  
**SAN 1742663** (789347) black  
**SAN 1742664** (789354) blue  
**SAN 1742665** (789362) red

**Package of 2**  
**SAN1742659** (828334) black  
**Package of 4**  
**SAN 1742662** (319186) assorted colours  
**Package of 12**  
**SAN 1802226** (1052216) assorted colours



**C** Sharpie®



**D** BIC®



**D Intensity Fineliners**

Erase and reveal: reveal new colours by erasing over area you wish to change. Water based ink. 0.4 mm. Fine tip. Package of 6. Assorted colours.  
**BIC FPCC6-AST** (832574)

**E Paint-It 011 Metallic Markers**

Suitable for many surfaces. Best results on dark and non-absorbent surfaces. Fast-drying ink. Fine point. Package of 4.  
**PSY ML01111502** (829649)  
 blue, red, yellow and green  
**PSY ML01111501** (829648)  
 silver, gold, copper and violet



**E** Schneider



**F** Schneider



**F Paint-It 310 / 320 Acrylic Markers**

Suitable for many surfaces: wood, metal, paper, cardboard, stone, etc. High coverage, quick-drying and high colour brilliance. Package of 6.  
**Paint-it 310 - 2 mm tip**  
**PSY 120195** (829651) black, white, blue, violet, red, green  
**PSY 120196** (829650) gold, silver, pastel blue, pastel purple, pastel pink, pastel green  
**Paint-It 320 - 4 mm tip**  
**PSY 120295** (829652) black, white, blue, violet, red, green  
**PSY 120296** (829653) gold, silver, pastel blue, pastel purple, pastel pink, pastel green

**G Metallic Outline Markers**

Package of 4. Assorted colours.  
**CY0 56-0474** (1000645)



**G** Crayola



**H** Pentel

**H Fabric Markers**

Fine point marker for fabric. Special ink takes on virtually all fabrics without excessive spreading. Resists fading. 2.0 mm tip. Package of 2. Black.  
**PEN M10BP2-A** (418699)

Find more fabric markers on **page 655**

**A Silly Scents™ Smashups Markers**

Scented. Rich, vibrant colours to match fragrances: Red Velvet Cake, Raspberry Macaron, Strawberry Shortcake, Upside-Down Cake, Key Lime Pie, Mint Chocolate Chip, Berry Smoothie, Fluffernutter, Caramel Macchiato and Smore. Nontoxic. Washable. Fine tip. Package of 10. Assorted colours.

**CYO 58-5810** (832694)



**B Tripod Grip Markers**

The triangular shape is easier to hold for toddlers who want to learn to colour. Washable. Package of 8. Assorted colours.

**CYO 80-6813** (832588)



**C Project XL Giant Markers**

Package of 4. Assorted colours.

**CYO 56-0482** (1000652)



**D S.Note Markers**

They are both a marker and a highlighter. The chisel tip allows you to quickly go from precise strokes to wide lines. The quick-drying ink keeps the job clean. Package of 24. Assorted colours.

**SAN 2158059** (828414)



**E Mr. Sketch Scented™ Washable Markers**

Each colour has a different scent: watermelon, cherry, orange, banana, mint, fruit punch, blueberry, cinnamon, licorice. Washable. Chisel tip. Package of 10.

**SAN1925829** (350868)



**F Double-Ended Fibre-Tip Pens**

Ideal for sketching, drawing, writing and colouring. Two tips for narrow and broad strokes. Line widths approximately 0.5 - 0.8 and 3.0 mm. Package of 36. Assorted colours.

**STD 3200TB36** (828306)



**G Colors of the World™ Colouring Book**

Young artists can colour their way across the globe with the Colors of the World colouring book. 48 pages. For age 3+

**CYO61-0586** (832586)

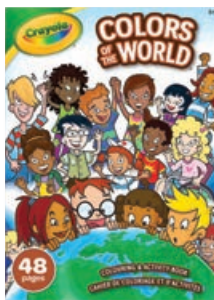

**H Colouring Book**

Animal Friends. 96 pages.

**CYO 61-0497** (832698)



**I Colouring Activity and Storage Set**

Keep art and tools neatly organized. Includes more than 65 pieces. 1 storage box. 22 crayons. 13 Pip-Squeaks® washable markers. 32 colouring pages. 1 sheet of colouring stickers. Nontoxic. 4 years and over.

**CYO 04-8292** (832598)





More Ways to Colour  
& Inspire Creativity



**A Fabric Fine Line Markers**

Create colourful custom designs on clothes and accessories. Non-toxic. Box of 10. Assorted colours. **CYO 56-7919** (832583)

**B Stampers Markers**

Fun shaped tips to add fun and excitement to projects and drawings. Washable. Pack of 10. Assorted colours. **CYO 56-8169** (832584)

**C Neon Light Effect Markers**

The 3-step layering system makes art pop like a neon sign. Non-toxic. Package of 7. Assorted colours. **CYO 04-0736** (832585)

**D Original Markers**

Broad tip. Box of 10. Assorted colours. **CYO 56-7708** (120121)

**E Ultra-Clean Washable Markers**

Assorted colours.  
**Broad line**  
**CY056-7910** (318915) classic colours - box of 10  
**CY058-7810** (317263) bold colours - box of 10  
**CY058-7811** (318840) tropical colours - box of 10  
**CY056-7916** (177741) classic colours - box of 16  
**CY056-7709** (815770) colors of the world - box of 24  
**Fine tip**  
**CY058-7510** (249607) classic colours - box of 12  
**CY056-8612** (608497) bold colours - box of 12  
**CY056-8524** (469106) classic colours - box of 24  
**CY056-8525** (832589) colors of the world - box of 24  
**CY058-7710** (832695) colors of kindness - box of 10

**F Scentsations Colouring Markers**

Washable. Scented. Broad tip. Box of 10. Assorted colours. **CY056-8149** (652941)

**G Pip-Squeaks® Markers**

Washable. Small size. Assorted colours. **CYO 58-2316** (724666) package of 16  
**CY058-4324** (744581) package of 24

**H Super Tips Colouring Markers**

Fine point than can draw thick. Washable. Assorted colours. **CY056-8106** (744565) package of 20  
**CYO 56-8150** (744615) package of 50

**I Washable Markers**

Easily washes off skin and most clothing. For precise work. Non-toxic and odourless. Fine and durable tips. Assorted colours. **DIX80680** (132332) package of 8  
**DIX80714** (536995) package of 12  
**DIX80715** (588277) package of 24  
**DIX80712** (1004126) package of 36





**A**



**B**

**Tracing Light Pad**  
5 mm LED tracing pad. Perfect for calligraphy and drawing. Lightweight and easy to carry. Includes 10 printed coloring sheets, 5 colouring pencils, 1 black tracing pen, sample pattern pages, storage box and one USB cable. 13.5 x 9.12 x 0.18 in. 7 yrs +.  
**EDI TT11351** (598961) Nebulous Stars  
**EDI TT15151** (823807) Dinosart

**B Nebulous Stars Colouring Book**  
Colouring is the trending activity to calm and develop your creativity. 60 black pages. 8 neon ink gel pens. 7 yrs +.  
**EDI TT11111** (598953)

**C Velvet Art - Small Creative Book**  
Includes 12 magic velvet boards. 5 mini markers. Informative pages about dinosaurs. Color instructions. 7 yrs and up.  
**EDI TT15204** (828997)

**D Playhouse**  
Colour in your house with markers, wax crayons or paint colours and be creative. Made of strong 32-ECT and safe construction with rounded edges. Lead-free design is F963 Standard consumer safety specification certified. 2 piece assembly that can be disassembled and stored. Functioning windows and doors for hours of fun. For age 3+.  
**37 x 37 x 43 in. H.**  
**FEL 1231401** (832565) castle  
**38 x 32 x 48 in. H.**  
**FEL 1230101** (832563) unicorn  
**FEL 1230201** (832564) treats 'n' eats



**C**



**D**



**E Storage Box to Draw**  
Toy Box that you can draw with markers or wax crayons. Quick assembly. Rolled edges to avoid paper cuts. Perfect to store kids toys, clothing or sporting gear. 28 x 18 x 18 in. H. For age 3+.  
**FEL 1231701** (832567) animals  
**FEL 1231601** (832566) sports

**F Coloured Washable Markers**  
Classpack. Conical broad line. Box of 200. 8 colours. 25 of each.  
**CY058-8200** (166983)

**G Ultra-Clean™ Wax Crayons**  
Classpack. Washables. 8 colours.  
**CY0 52-8038** (833096) box of 400 (50 of each)  
**CY052-8800** (166975) box of 800 (100 of each)



**E**



**F**



**G**



## A Monster Morning Game

Mornings are crazy in the monster's lab-dorm. Some mischievous little monsters hide to avoid the morning routine. Play the different games and plan your turns carefully to be the first to catch your pack of monsters. Bilingual. 2-4 players. For age 6+.

EDI GLA3125 (808170)



A

## B Hide & Seek Game

Youngsters will have fun playing while awakening to the world around them and stimulating observation and focus.

EDI GLA8000 (573469) dinosaurs

EDI GLA8030 (598979) animal world

EDI GLA8031 (808154) enchanted world



B

## C Dragons & Ladders Game

Enter the medieval fantasy world of dragons & ladders. In this totally new version of the classic snakes and ladders game, players become heroes attacking a castle looking for the fabulous treasure guarded within. You must fight hard and use your powers strategically to reach the treasure room and defeat the three-headed dragon. Bilingual. 2-6 players. For age 7+.

EDI GLA2853 (829618)

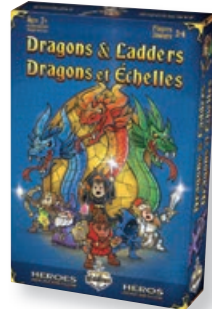

C

## D Extreme Dinosaurs

Make, paint and varnish your own spinosaurus nest with eggs, and egg stealer crime scene models. Assemble and paint a detailed timber model of a velociraptor. Build and decorate your museum quality prehistoric swamp diorama to display all your models. Learn the amazing secrets of 10 of the world's most extreme and unusual dinosaurs. Beautifully written and illustrated full-colour booklet. Bilingual. 1-player. For age 9+.

EDI WES6211 (829619)



D

## E DinosArt Diamond-by-Numbers

Special applicator to apply micro-gems to adhesive templates included. Numbers associated with each colour.

EDI TT15051 (823809)



E

## F DinosArt Watercolour Paint

The glow in the dark pre-varnished line art helps the watercolour stay in the right areas. Glows in the dark. Dinosaur pictures. Pack of 5 canvases to paint.

EDI TT15052 (823808)



F

## G Nebulous Star Paint-by-Number on Canvas

Classic paint-by-number activity on wood-framed printed canvas. Make it shine with gems and glitter varnish. For age 7+.

EDI TT11421 (808196)



G

## H Paint and Create Easel Case

A painting workshop to take everywhere with you. The durable case contains more than 65 parts: easel, paint pots, watercolours, short watercolour pencils, sketch pencils, white crayons, paint brushes, mixing trays, sticker set, watercolour paper sheets and technique guide.

CYO 04-8291 (832599)



H

## I Cat Memories Puzzle

27 x 20 in. 1,000 pieces.

EDI CT10085 (823802)



I

## J Nebulous Stars Puzzle

Glitter finish to add even more magic.

EDI TT11651 (829621)

Nebulia & Stella - 100 pieces

EDI TT11661 (829622)

Petulia & Paloma - 200 pieces

EDI TT11671 (829623) Nebulia & Firiaz - 300 pieces



J



# Dedication

Preparing the next generation for the world of work has never been more important. This next section is dedicated to the teachers who have dedicated themselves to the task. Here you will find the necessary tools to prepare yourself and your classroom for a successful year.

# EDUCATION

## SCHOOL SUPPLIES

Notebooks and Stationery .....	660
Dictionaries .....	662
Small Classroom Tools .....	664
Writing and Correction .....	668
Whiteboards and Accessories .....	674
Timetimer .....	675
Binders and Report Covers .....	676
Classroom Storage .....	679

## EARLY LEARNING

Educational Toys .....	682
Flash Cards .....	683
Children's Headsets .....	683

## CLASSROOM FURNITURE

Activity Tables .....	684
Student's Desks and Chairs .....	685
Teacher's Desks .....	686
Bookcases .....	686
Mobile Storage Units .....	687



## Be ready for our Seasonal School Promotion in July and August.

This annual event features all the newest fashion trends in backpacks, pencil cases and lunch boxes as well as all the latest must-have gadgets.



**A**  **Blueline®**



**B**  **Blueline®**



**A Rediform Notebooks**

Assorted notebook pack features soft, flexible covers in a variety of bright colours to colour-code your different subjects or projects. Center-sewn binding. High-quality paper helps to resist ink from bleeding through. 64 pages per notebook. 5.75 x 8.25 in. Pack of 5. Assorted colours.  
**BLI A85** (1046804)

**B Undated Task Planner**

Padded, laminated cover. Twin-wire binding. 270 micro-perforated pages. Spaces for today's plan, priorities, calls and notes section. 9-1/4 x 7-1/4 in. Bilingual. Black. 50% post-consumer recycled paper. FSC® certified.  
**BLI B310B-81** (581769)



**C** 



**D** 

**C Notebook**

Polypropylene cover. Geometric square pattern. Spiral binding. Ruled. 200 pages (100 sheets). 10 1/2 x 8 in. Assorted colours.  
**HLR 66182** (181859)

**D Spiral Notebook**

3-hole punched. 10-1/2 x 8 in. Assorted colours. SFI certified.

**Ruled. 1 subject**  
**HLR 13121** (222851) 80 pages  
**HLR 13129** (318006) 100 pages  
**HLR 05553** (732784) 140 pages  
**HLR 13224** (257238) 200 pages  
**HLR 13223** (222869) 250 pages

**Ruled. 3 subjects**  
**HLR 13111** (257220) 108 pages  
**HLR 05783** (595397) 240 pages  
**HLR 13225** (32169) 300 pages

**Ruled. 5 subjects**  
**HLR 05693** (442640) 360 pages  
**Quadruded. 4 squares/in.**  
**HLR 13222** (257261) 80 pages  
**HLR 13009** (617977) 200 pages  
**Quadruded. 5 mm**  
**HLR 13005** (275503) 80 pages



**E** 



**F** 

**E Notebook**

Ruled space on cover offers space to write your name, subject and more. Index page. 2 fasteners. Includes tab dividers and reminder stickers. Title and date box on pages allow detailed note-keeping. Double-wire binding. 200 pages. 8.5 x 11 in. Assorted colours.  
**HLR 13048** (1046739)

**F Metric Graph Paper Notebook**

Graph ruling maximizes space for notes and graphs. Coil binding. Pre-punched design fits in standard letter-size binders. Protective cover keeps your notes protected. 80 pages. 8 x 10.5 in.  
**HLR 66368** (800581)



**G** 



**H** 

**G Ruled Exercise Book**

3-hole punched. 10-7/8 x 8-3/8 in.  
**HLR 12107** (473462) 80 pages. Pack of 3  
**HLR 12692** (546457) 32 pages. Pack of 4  
**HLR 12984** (275495) 40 pages. Sold individually

**H Canada Notebook**

Laminated cover. 3-hole punched. 11 x 8 in. Assorted colours.  
**GCI 40412315** (681189) ruled - 40 pages  
**GCI 412380** (132126) ruled - 80 pages  
**GCI 40412325** (681197) metric quad - 40 pages



**I** 



**J** 

**I Writing Book**

Laminated cover and thick paper. 32 pages. 9 x 7 in. Assorted colours.  
**GCI LG10** (107003) interlined-dotted  
**GCI LG20** (106997) interlined  
**GCI LG25** (132118) wide interlined  
**GCI LG30** (747220) project  
(1/2 plain - 1/2 interlined/dotted)  
**GCI LG40** (781898) metric quad

**J Quebec Interlined Dotted Lines Writing Book**

28 pages. 9 x 7 in.  
**HLR 12182** (275461)

## A Ruled Loose Leaf Sheets

Hole-punched. 10-7/8 x 8-3/8 in.  
**HLR05233** (25809) package of 200  
**HLR05240** (232173) package of 400



## B Perf-Perfect® Figuring Pad

Detachable clean edge. 50 sheets.  
**Note size - 5 x 8-3/4 in. - sold individually**  
**HLR54236** (192435) ruled 8/32  
**Letter size - 8-1/2 x 11-3/4 in. - sold individually**  
**HLR54130** (192419) ruled 11/32 - white  
**HLR54132** (192427) quadruled 4 sq./in. - white  
**Letter size - 8-1/2 x 11-3/4 in. - pack of 10**  
**HLR54131** (529297) ruled 11/32 - canary yellow

## C Telephone Message Pad

72-sheet pad. 3-1/2 x 5 in. Package of 25. Pink.  
**HLR46524** (662510) French  
**HLR46501** (588004) English  
**HLR46505** (662502) bilingual

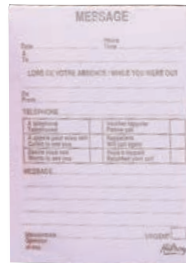

## D Post-It® Notes and Flags Combo

Allows to mark documents without writing on them and allows colour-coding the important information. 9 pads of 50 sheets each: 1 of 3 x 4 in. 3 of 7/8 x 2-7/8 in. and 5 of 1/2 x 1.7 in. Repositionable. Assorted colours.  
**MMM670COMBO-C** (587485)



## E Post-It® Original Notes

Sticks to almost any surface. Repositionable. Fun and vibrant colours help to draw attention. Made with plant-based adhesive. All Post-it® notes are recyclable. 100 pop-up sheet pad. 3 x 3 in. Package of 6.  
**MMMR3306AU12C** (661439) floral fantasy  
**MMM R330-AN** (661454) popitistic  
 • Dispenser  
**MMMSTL330-B** (573725) black



## F Peel-To-Seal Envelopes

#10. Self-sealing. 24 lb. 4-1/8 x 9-1/2 in. Box of 500. White.  
**BSN04646** (1050871)

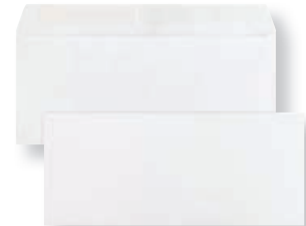

## G White Envelopes

Side opening. 24 lb. Box of 500. White.  
**Standard. Without window.**  
**BSN42250** (1050434) #10. 4-1/8 x 9-1/2 in.  
**Standard. With window.**  
**BSN42251** (1050450) #10. 4-1/8 x 9-1/2 in.



## H Catalogue Envelopes

Open end. 24 lb. 9 x 12 in. Box of 250. Kraft.  
**BSN42104** (1050624)



## I Dab N Seal® Envelope Moistener With Adhesive

Spring-valve applicator. Dries fast. Glues more than 1,000 envelopes and other paper products.  
**QUA46067** (201392)





**A**



**B**

**A Petit Larousse illustré 2023 Dictionary**

French dictionary of common and proper nouns. The 2023 edition includes 150 new words, senses and expressions.

**LMA 828422** (828422) Petit Larousse illustré 2023  
**LMA 828423** (828423) Larousse de poche 2023

**B Larousse Pocket Bilingual Dictionary**

Dictionary of foreign languages. More than 200,000 words, expressions and translations.

**LMA 829022** (829022) French/English  
**LMA 829023** (829023) French/Spanish

**C Harrap's Petit Dictionnaire Bilingual Dictionary**

2021 Editions. French/English.  
**LMA 770170** (574368)

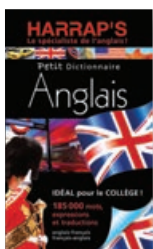

**C**



**D**

**D Bescherelle**

**L'Art de conjuguer**  
**HMI 192831** (192831)  
**L'Orthographe pour tous**  
**HMI 259960** (259960)  
**La Grammaire pour tous**  
**HMI 747337** (747337)

**E Bescherelle I: Complete Guide to Conjugating**

It's a simple and effective tool for anglophones who would like to learn French conjugation. 12,000 French verbs and their conjugation.

**HMI 116624** (116624)



**E**



**F**

**F Dictionnaire des synonymes et des antonymes**

French synonyms and antonyms. Complete and concise repertory. Levels of meaning. Proper or figurative meaning, meaning by extension or by analogy.

**SOC Z05810** (198994)

**G Antidote 11 Software**

More than 16,000 targeted errors. Grammar, spelling, typography and style corrections. Clear explanations. 820,000 word combinations with real-life examples including 29,000 proper nouns, 56,000 common expressions, 1,600,000 synonyms, 128,000 antonyms and 9000 verbs with all conjugated forms. Integrated Wikipedia access. Syntaxe, grammar, lexicon, punctuation, business writing and many more guides. Compatible with Microsoft Windows 10 and 11, Mac Big Sur 11 and Monterey 12. Choice of English or French can be decided when downloaded.

**PDN A111927** (828054)



**G**



**H**

**H Tap'Touche Software**

Tap'Touchel is a proven way to quickly learn to type faster. The Cd-ROM software offers you a rich and diversified teaching program with more than 200 activities and evaluation tests. The subscription lasts 1 year. Bilingual.

**PDN A075623** (833136) Personnel Edition (1 user)  
**PDN A075624** (833137) Family Edition (3 users +)

**I Geo-Fix Adhesive Film**

Thickness 0.6 mm.  
**GCI 452AC** (119958) 18 x 60 in.  
**GCI 452S** (419697) 18 in. x 75 ft.



**I**





# The very best for our environment



STAEDTLER®

Head of ideas.

All Lumocolor® and highlight markers feature

## Pen housing

(barrels and caps)

## made from 97% recycled plastic



STD 318WP8



STD 305FWP41



STD 60-BK-6



STD 3620TB10LU



STD 182-C10

## WOPEX® The Eco Pencil

A natural fibre composite material that sets new standards using certified wood from sustainably managed forests.



Select graphite or color pencil sharpening by turning the dial

STD 511-132

STD 525B20



**A** X-ACTO™



**B** BOSTITCH

**A KS Wall Pencil Sharpener**

Wall or table mounting. 8 pencil sizes. Chrome and black. Limited 2-year warranty. **EPI 1031T** (24646)

**B Pencil Sharpener**

Wall or table mounting. 8 holes. Antimicrobial protection. Black. **BOS MPS1-BLK** (560623)

**C Quiet Electric Sharpener**

XHC cutter technology for 70% faster sharpening and 10 x longer life. Super duty motor, quiet stall-free operation. MagnaSafe tamper-proof safety switch shuts down motor when tray is removed. 6 size selector dial. High capacity shavings tray. Oversized base with suction cup feet. 7 Year Limited Warranty. **BOS EPS10HC** (466334)

**D School Pro Electric Sharpener**

Smart Stop® and Safe Start® features, prevents over-sharpening. Cutters disengage when the correct pencil point is achieved. Special cutting system provides a sharp rounded point. 6-size dial, fits nearly every pencil. Compatible with coloured pencil. Auto-reset motor shut-off prevents overheating. Large shavings receptacle. Slip resistant bottom. **EPI 1670XT** (806133)



Quiet!

**C** BOSTITCH



**D** X-ACTO™

**E NeXXt Series Desktop Stapler**

Easily staples up to 40 sheets at once. Direct Impact technology ensures you always get a jam-free staple for consistent performance. Stapler also opens for tacking and includes an adjustable anvil for open or closed stapling. Standard staples.

- SWI 55047095** (1032250) black
- SWI 55047001** (1032291) white
- SWI 55047036** (1032267) blue
- SWI 55047023** (1032283) pink
- SWI 55047044** (1032275) orange

**F Staple Remover**

Easily removes staples from documents. Compact size for easier storage and portability. Plastic and metal construction. Mahogany. **ACM 21550** (15230)



**E** *Swingline*



**F** WESTCOTT  
Depuis 1872 Since 1872\*

**G Light Touch® Paper Punch**

With lever handle. High capacity. Punches from 2 to 7 holes of 9/32 in. diameter and up to 20 sheets. Soft-touch lever. Built-in paper guide. Limited lifetime warranty. **SWI 74030** (482018)  
• 9/32 in. punch head  
**SWI 74865** (739847)

**H Precision Pro® Paper Punch**

Punches 2 or 3 holes of 9/32 in. diameter and up to 10 sheets. Semi-adjustable punch heads for flexible punching. **SWI 74037** (536300)



**G** *Swingline*



**H** *Swingline*



**I Desktop Tape Dispenser**

Complements any decor. For tapes up to 19 mm x 33 m. Black. **MMM C60-BK** (714295)  
• Tape refill  
**MMM 600-18BXD** (229393)

**J TL902-C Laminating Machine**

Has a two-roller system and two temperature settings to efficiently laminate items up to 22.86 cm (9 in) wide. Convenient and easy to use. Can be used to preserve photo quality, documents, artwork and to create teaching aids. **MMM TL902-C** (806430)  
• Thermal Laminating Pouches  
**MMM 529594** (529594) 3 mil. Letter size. Pack of 50.



**I** **Scotch**  
BRANDMAKING



**J** **Scotch**  
BRANDMAKING

## A Kidi Cut Preschool Scissors

Ideal for initiation to cutting. Fiberglass blades that do not cut hair or clothes and do not conduct electricity. Assorted colours.  
**MAP 378146** (440438)



## B Kids Scissors

5 in. blade. Right and left-handed use. Assorted colours.  
**ACM 40005** (454611) rounded tips  
**ACM 40025** (731554) pointed tips

## C School Scissors

Stainless steel blades. Plastic handles. 10 year warranty.  
**Right-handed**  
**ACM 11237** (454728) 6 in. rounded tips - red  
**ACM 11239** (210591) 6 in. semi-pointed tip - blue  
**Left-handed**  
**ACM 11127** (122424) 6 in. semi-pointed tip - green  
**ACM 11257** (233007) 7 in. pointed tip - green



## D Straight Scissors

Stainless steel blades. Plastic handles. 5-year warranty. 8 in. Black.  
**ACM 02208** (560540)

## E Scotch® Multi-Purposer Scissors

8 in. blades. Sharp, hardened stainless steel blades for smooth cutting action. Soft comfort grip handle. For both right and left handed users. Great for photos, papers and crafts. 10-year limited warranty.  
**MMM 1428ESF** (331785)



## F Scented Glue Sticks

6 scents: strawberry, mango-pineapple, limeade, grape, watermelon and tropical orange. Washable. Non-toxic. 6g. Box of 30.  
**EPI 2175692** (829678)



## G Washable White Glue

Non-toxic. 3.8 litres.  
**EPI 6155060341** (426072)



## H Flexible Transparent Ruler

**ACM 40806** (122440) 15 cm metric / 6 in.  
**ACM 40812** (122432) 30 cm metric / 12 in.  
**ACM 40830** (25684) 30 cm metric



## I Metal Ruler With Cork Backing

**ACM 50201** (210450) 30 cm metric / 12 in.

## J Transparent Metric Shatterproof Ruler

Assorted colours.  
**ACM 14381** (782417) standard (30 cm)  
**ACM 15989** (266122) neon (15 cm)



## K Plastic Stencil

For perfect letters and numbers. Durable and flexible plastic.  
 4-piece set.  
**ACM 02145** (386482)



# Collections



sandwich and snack reusable bags

2022 collections illustrated

backpacks, pencil cases, snack bags, lunch boxes  
carry-all bags, arts and crafts smocks

## Stationery

### REPORT COVERS

- Made of heavy duty laminated paper
- Pockets and fasteners or fasteners only
- Available in 5 pastel colors



#CVP10AST, #CVP15AST, #CVP20AST

### PRESENTATION BINDERS

- Presentation pockets on every side
- 2 inside pockets
- 1", 1.5" and 2" D-shaped rings
- Available in 6 pastel colors



#34000P, #34200P

## A Xcellence Geometry Set

Superior quality, includes safety points on compass and dividers.  
Self centering mechanism. 10-piece. Includes: a 6 in. ruler, 2 triangles, 1 protractor, 1 lettering guide, 4 in. compass, 4 in. divider, a wooden pencil, a sharpener and an eraser. Metal case.  
**STD 557-10-BN** (544494)



## B 4-Piece Geometry Set

Set includes a 4 in. protractor, a 6 in. (15 cm) ruler, a 30-90-60 degree triangle and a 45-90-45 degree triangle. Durable clear plastic.  
**ACM 11104** (648014)



## C Protractor

10° increments. 4 in. Transparent.  
**STD 568-50-10** (228098)



## D Triangle

Made of durable plastic. Easy to use.  
**ACM 00460** (317776) 30-60°/100 mm  
**ACM 00445** (317768) 45°/80 mm



## E EL531XTBWH Scientific Calculator

12-digit, 2-line LCD display. 273 functions. 2 modes: normal and stat. 8 temporary memory buttons. 1 and 2 variable statistics.  
**SHR EL531XTBWH** (430660)



## F Coloured Paper Clips

Metal with vinyl coating. Rust resistant.

**Box of 100**  
**ACC 72522** (754952) #1 (1-1/8 in.)  
**ACC 72523** (754960) #5 (2 in.)  
**Box of 500**  
**ACC 72524** (1030642) #1 (1-1/8 in.)



## G Foldback Clips

Includes 12 mini 1/2 in. 12 small 3/4 in. 6 medium 1-1/4 in. Polished.  
Box of 30.

**ACC 71138** (716472) silver  
**ACC 71130** (281691) assorted colours



## H Heavy-Duty Paper Trimmer

Cutting capacity up to 15 sheets. 12 in. cutting edge. Heavy-duty plastic base with rubber feet. Ergonomically designed detachable pistol grip handle. 13 x 13 in. Limited two-year warranty.  
**EPI 26232T** (1031707)



## I Explorer Globe

12 in. Striking colours. Blue globe and gold-colored base.  
**REP 30551** (683250) French  
**REP 30501** (683219) English



## J Geopolitical Canada Map

Canada provinces and territories flags. Laminated. Bilingual.  
33 x 49 in.  
**REP 72117** (271189)





**A** **BIC**



**B** **uni**



**A Gel-Ocity™ Retractable Rollerball Pens**

Quick dry super smooth writing gel ink. Medium point.  
**Package of 4**  
**BIC 428623** (428623) assorted colours  
**BIC 428631** (428631) assorted fashion colours  
**Package of 8**  
**BIC RGLCGAP81A** (428649) assorted fashion colours

**B Spectrum Retractable Gel Pens**

Smooth-flowing, vibrant gel ink. Translucent barrel. Medium point, 0.7 mm.  
**Package of 3**  
**UBC 70182C** (828345) blue  
**UBC 70181C** (828344) black  
**Package of 6**  
**UBC 70183C** (828340) assorted colours

**C One Retractable Gel Pens**

Quick-drying ink. Resists smudging and staining. Clear and crisp writing. The specially formulated ink stays on the fibers instead of being absorbed by the paper. Medium point. 0.7mm

**Package of 3**  
**UBC 70323C** (828342) blue  
**UBC 70322C** (828341) black  
**Package of 5**  
**UBC 70324C** (828343) assorted colours  
**• Package of 2 refills**  
**UBC 70409** (828354) blue  
**UBC 70408** (828353) black



**C** **uni**



**D** **Paper Mate**

**D InkJoy® Gel Retractable Ballpoint Pens**

Super smooth ink gel system, dries quickly. Rubberized grip. 0.7 mm. Package of 14. Assorted fashion colours.  
**PAP 1959302** (371443)

**E GR8 Gel Retractable Rollerball Pen**

Gel ink. Rubberized grip. Acid-free, archival-quality. 0.7 mm.  
**ZEB 42620** (103382) blue  
**ZEB 42610** (103374) black  
**ZEB 42630** (103390) red  
**ZEB 42680** (103523) purple



**E** **ZEBRA**



**F** **Pentel**



**G** **Pentel**

**F EnerGel® Retractable Rollerball Pen**

Metal tip. Quick-drying liquid gel ink is perfect for left-handed people and anyone jotting notes down in a hurry. Rubberized grip. 0.7 mm point. 54% recycled content.  
**PEN BL77-C** (751214) blue  
**PEN BL77-A** (751206) black  
**PEN BL77-B** (102905) red  
**PEN BL77-D** (808592) green  
**PEN BL77-V** (102913) purple  
**PEN BL77-P** (548099) pink  
**PEN BL77-F** (548115) orange  
**PEN BL77PW-C** (808618) pearl/blue  
**PEN BL77PW-A** (1009794) pearl/black  
**PEN BL77PW-P** (1009802) pearl/pink

**G EnerGel® 2S Multi-Function Gel Roller Pen**

High-performance EnerGel® ink technology combines the best qualities of liquid and gel inks for a super-smooth writing experience. Includes a 0.5 mm mechanical pencil. Black and red ink.  
**PEN BLW355A** (601534)



**H** **BIC**



**I** **BIC**

**H 4 Color Retractable Ballpoint Pens**

4 colours in 1 pen. Perfect for recording data in different colours without having to switch pens. Pocket clip. Medium point.  
**Package of 3.**  
**BIC MPP31-AST** (832575)

**I 4-Color™ 3+1 Retractable Ballpoint Pen + Pencil**

Ideal for marking information in different colors without having to change pens. Includes 0.7mm mechanical pencil, 2HB leads and spare eraser. Pocket clip. Medium point. 3 colors of ink, blue, black and red.  
**BIC MMLP1-AST** (428599)

**A Ecolutions™ Clic Stic®**

**Retractable Ballpoint Pens**

Long Lasting ink with 1.0 mm medium point. Package of 10. Blue.  
Made of 78% recycled plastic.  
BIC CSEM10-BLU (832577)



**B Cristal® Ballpoint Pens**

Easy Glide ink system. Clear barrel. Medium point. 1.0 mm. Box of 12.  
BIC MS11C-BL (111963) blue  
BIC MS11C-BK (111971) black  
BIC MS11C-RED (111997) red



**C Write Bros.® Ballpoint Pens**

Designed for comfortable writing. Ultra-low viscosity ink.

**Fine point. Box of 12**

PAP 2124512 (806050) blue  
PAP 2124515 (806067) black  
PAP 2124517 (806075) red

**Medium point. Box of 12**

PAP 3311131C (660423) blue  
PAP 3331131C (660407) black

**Medium point. Box of 60**

PAP 4621501C (232884) blue  
PAP 4621401C (232876) black

A



B



**D InkJoy™ 100 Retractable Ballpoint Pens**

Super smooth low viscosity ink system. Triangular barrel. 1.0 mm point.

**Package of 8**

PAP 1945935 (234765) assorted colours

**Box of 12**

PAP 1951253 (234740) blue  
PAP 1951254 (234732) black  
PAP 1951252 (234757) red



C



D



**E BPS Ballpoint Pen**

Stainless steel tip. Oil-based ink. Refillable.

**Fine point**

PIL 084584 (37481) blue  
PIL 084560 (37499) black  
PIL 084577 (37507) red  
PIL 084591 (37515) green

**Medium point**

PIL 084645 (38588) blue  
PIL 084621 (38612) black  
PIL 084638 (38604) red  
PIL 084652 (38596) green



E



F



**F R.S.V.P.® Retractable Ballpoint Pen**

Rubberized grip. 1.0 mm. 61% recycled content.

PEN BK93-C (161091) blue

PEN BK93A (161075) black

PEN BK93B (161083) red

PEN BK93CRD-D (808550) green

PEN BK93CRV-V (1009174) purple

PEN BK93CRS-S (1009166) sky blue



**G Z-Grip™ Retractable Ballpoint Pen**

Rubberized grip. Medium point.

ZEB 22220 (711572) blue

ZEB 22210 (711564) black

ZEB 22230 (711580) red

ZEB 22240 (711598) green

ZEB 22280 (711606) purple



G



H



**H Jetstream Elements Ballpoint Pens**

Combines the smoothness and vibrancy of a gel pen with the quick-drying features of a ballpoint. Comfortable grip. Uni Super Ink that protects against water, fading and fraud. 1.0 mm.

**Pack of 3**

UBC 70320 (828347) blue ink

UBC 70180 (828346) assorted colours

**Package of 5**

UBC 70138C (817858) assorted colours





**A** uni



**B** PILOT



**A Onyx Rollerball Pens**

Strong metal tip produces smooth, consistent writing. Durable plastic clip. Box of 12.

- 0.5 mm**
- UBC 60041** (140293) blue
- UBC 60040** (140285) black
- UBC 60042** (140301) red
- 0.7 mm**
- UBC 60145** (140319) blue
- UBC 60143** (140327) black
- UBC 60144** (140335) red

**B Hi-Tecpoint RT Retractable Rollerball Pen**

Retractable needle point for precise writing and drawing. Rubberized grip for superior comfort. Liquid ink. Refillable.

- 0.5 mm**
- PIL 342882** (777839) blue
- PIL 342868** (777847) black
- PIL 342875** (777854) red
- 0.7 mm**
- PIL 342967** (777862) blue
- PIL 342943** (777870) black
- PIL 342950** (777888) red



**C** PILOT



**D** PILOT

**C FriXion® Ball Erasable Rollerball Pens**

Frixion® lets you write, erase, re-write. Thermo-sensitive gel ink disappears with erasing friction coming from the rubber tip. Refillable. Not recommended for legal or official documents.

- 0.7 mm. Package of 6. Assorted colours.
- PIL 004382** (112011)

**D FriXion® Clicker Erasable Pens**

Frixion® lets you write, erase, re-write. Thermo-sensitive gel ink disappears with erasing friction coming from the rubber tip. Side click retractable and refillable. Not recommended for legal or official documents. Package of 4. Assorted colours.

- PIL BLFRT5P-S4** (234971) 0.5 mm
- PIL BLFRT7P-S4** (234963) 0.7 mm



**E** PILOT



**F** Pentel



**E FriXion® Erasers**

Removes ink easily for all Frixion products. Ideal for removing small or large surfaces. Package of 2.

- PIL EFR2** (829632)

**F Correction Pen**

Metal tip. 12 ml. 37% recycled content.

- PEN ZL31-W** (247817)

**G Wite-Out® Mini Correction Tape**

Stong and tear resistant. 5 mm x 8 m. Box of 12. Assorted colours.

- BIC WOTM11-WHI** (832572)

**H Left/Right Handed Correction Tape**

180° swivel head for left and right handed use. Single line. Disposable. Uniform application. 5 mm x 10 m.

- GCI BCT-1158-C** (475616)



**G** BIC



**H** OutMark





**A Xtra-Life Mechanical Pencils**

Box of 12. Assorted colours.  
**BIC MPF11** (660449) 0.5 mm  
**BIC MP11** (660431) 0.7 mm



**B Profile Mechanical Pencils**

0.7 mm. HB. Package of 36. Black.  
**PAP 2101947** (829680)



**C Jumbo Triangular Pencil**

Jumbo ergonomic triangular shape. Ideal for first writing and drawing exercises. Break-resistant, super-bonded lead. 4 mm. HB (#2). FSC® certified.  
**STD 11922** (580092)



**D Norica® Pencils**

Sharpened. With latex-free eraser. Box of 12. FSC® certified.  
**STD 132-46CB12** (718742) HB  
**STD 132462HC12** (736371) 2H



**E Woodcase Pencils**

Pre-sharpened. Hexagonal shape. Latex free eraser tips. Box of 144. Made from 100% FSC® certified wood.  
**STD 13247C144** (595488)



**G NiceTouch Foam Pencil Grips**

Comfort grip. Package of 5. Assorted colours.  
**MGE 778407** (778407)



**H Mars Plastic White Eraser**

For paper and film. Latex-free.  
**STD 526-50UP** (227959)



**I Mars Plastic Eraser Holder**

Latex-free eraser.  
**STD 528-50** (480095)  
 • Refill. Pack of 2  
**STD 528-55-BK2** (799650)



**J Eraser Holder**

For standard eraser. Assorted colours.  
**MAP 120049** (343368)

# Sharpie® S·NOTE™

**BOTH AN  
ART MARKER  
AND A HIGHLIGHTER**

Sharpie® S-Note™ creative markers are versatile and fun, and they're both a marker and a highlighter. Add colour to note-taking, underlining, highlighting, drawing and more.



**NEW!**

Premium, dual-ended design with a 2-in-1 chisel tip and a new fine bullet tip



**CHISEL TIP:** Quickly change between precise & broad lines



## **BRING NOTES TO LIFE**

- No-bleed colours for organization and creativity

## **MILD, SEE THROUGH COLOURS**

- Great for highlighting & drawing



Sharpie®  
S-Note®  
DUO  
Markers,  
8 Pack

SAN 2154173  
\$



Sharpie®  
S-Note®  
Markers,  
12 Pack

SAN 2158060  
\$

## A S-Note Markers

They are both a marker and a highlighter. The chisel tip allows you to quickly go from precise strokes to wide lines. The quick-drying ink keeps the job clean. Package of 6. Assorted colours.  
**SAN 2130683** (815713)



**A** Sharpie



**B** Sharpie



## B S-Note Dual Tip Markers

Chisel tip. No bleed ink. Versatile 2 in 1 tip. Package of 16. Assorted colours.  
**SAN 2154174** (829337)



## C FriXion® Light Erasable Highlighters

Frixion® lets you write, erase, re-write. Thermo-sensitive gel ink disappears with erasing friction coming from the rubber tip. Chisel tip. Package of 6. Assorted vibrant fluorescent colours.  
**PIL 375248** (112037)



**C** PILOT

**D** BIC



## D Intensity Pastel Highlighters

Chisel tip. Rubberized grip for added comfort. Won't dry out when the cap is left off for +/-8 hours. Package of 12. Assorted colours.  
**BIC 6BLD11-AST** (832573)



## E Tank Highlighters

Smear Guard ink. Chisel point for both wide and narrow lines of text.  
**Box of 12**  
**SAN 25025** (565010) yellow  
**SAN 25009** (242743) pink  
**SAN 25006** (242115) orange  
**SAN 25026** (242149) green  
**SAN 25010** (242131) blue  
**Box of 36**  
**SAN 1920938** (572578) yellow

## F Double-Ended Highlight Pens

Water-based ink. On one side there is a chisel tip for highlighting, on the other side there is a brush tip for fancy lettering and decorative elements. Box of 10. Assorted colours.  
**STD 3620TB10LU** (833116)

**D** BIC



## G Triplus® Fineliner Markers

Dry-Safe ink. Can be uncapped without drying. For fatigue-free writing. Triangular body. 0.3 mm point. Package of 10. Assorted colours. 46% recycled content.  
**STD 334SB10A6** (705202)



**E** Sharpie



**F** STAEDTLER



## H Sharpie® Markers

Ideal for notetaking, letter writing and card making. Precise, consistent line width. Durable and smudge resistant ink. Won't bleed through paper. Needle point. Package of 4. Assorted colours.  
**SAN 1742662** (319186)



## I Flair Scented Pens

Felt tip pens inspired by Sunday Brunch: Smell of sweet Sugared Grapefruit, rich Hazelnut Latte and even more! Package of 6. 0.7 mm medium point.  
**PAP 2125407** (828327)



**G** STAEDTLER



**H** Sharpie



**I** Paper Mate



**A**



**A Economy Magnetic Dry Erase Whiteboard**

Durable melamine surface. Mounting hardware and marker tray included. Aluminum frame.

**QRT 23230** (417295) 36 x 24 in.

**QRT 23340** (417311) 48 x 36 in.

**QRT 23460** (44271) 72 x 48 in.

**QRT 23480** (417345) 96 x 48 in.

• **Board hangers for partition**  
**QRT 75010** (278382) package of 2

**B**



**B Prestige 2® Total Erase® Magnetic Dry Erase Whiteboard**

Highly durable magnetic surface resists ghosting, staining, scratching and denting. Light grid pattern guides straight writing. Pass-thru mounting system. Exclusively compatible with Prestige® 2 Connects™ accessories. Full length marker tray. 20-year warranty.

**Aluminum frame**

**QRT 20057** (247833) 48 x 36 in.

**QRT 20058** (247866) 72 x 48 in.

**QRT 20059** (247908) 96 x 48 in.

**Graphite frame**

**QRT 20061** (247924) 48 x 36 in.

**QRT 20062** (247932) 72 x 48 in.

**C**



**C Standard Dry Erase Whiteboard**

Anodized aluminum frame. White melamine surface. Can be mounted horizontally or vertically. Non-magnetic. Marker tray included.

**QRT 53100** (606426) 24 x 18 in.

**QRT 53300** (606434) 36 x 24 in.

**QRT 53400** (606442) 48 x 36 in.

**QRT 53500** (426114) 60 x 36 in.

**QRT 53700** (606459) 72 x 48 in.

**QRT 53800** (606467) 96 x 48 in.

**D Magnetic Whiteboard Eraser**

Sleek plastic handle. Magnetic for easy storage and access on a magnetic dry-erase board. Comes with 3 adhesive refill pads.

**QRT 6447415800** (278176)

**E EnduraGlide® Dry Erase Whiteboard Kit**

Includes 4 markers in assorted colours, an eraser and a 1.68 oz pump spray cleaning solution. Even ink flow, low odour, quick drying. Visible ink level. Chisel tip.

**QRT 03922** (111443)

**F Expo® Whiteboard Markers**

Dry erasable. Low odour. Box of 4. Assorted colours.

**SAN 1825974** (242412) chisel point

**SAN 82074** (1052026) bullet point

**G Dry Erase Markers**

Low odour. Erases easily. Chisel tip. Box of 192. 8 assorted colours.

**SAN 2003995** (828880)

**D**



**E**



**F**



**G**



**A Learning to Manage Time**

How much longer? For anyone who wants to measure and manage time more effectively, Time Timer® is an innovative visual timer designed to "show" the passage of time through the use of a patented coloured disk that disappears as time elapses. Unlike traditional timers that fail to make the abstract concept of time concrete, Time Timer's visual depiction of "time remaining" provides stress-free time management at work, school and home to make every moment count.

**Time Timer® 3 - (60 minutes)**

TTM TTA4-W (520478) black

**Time Timer MOD® 4 - (60 minutes)**

TTM TTM9-W (570945) black

TTM TTM9-BL-W (570952) sky blue

TTM TTM9-GR-W (570960) green

**Time Timer® 8 - (60 minutes)**

TTM TT08B-W (832568) black

TTM TTP7-W (520452) grey

**Time Timer® 8 - set of 3 timers**

TTM TT08BSEC3W (827980) orange, purple, green

TTM TT08BPRM3W (827979) blue, red, yellow

**Time Timer PLUS® 8 - (20 minutes)**

TTM TT20-W (520460) white

**Time Timer® 12 - (60 minutes)**

TTM TTA2-W (520486) black



**B Max Alkaline Batteries**

AA. Package of 24.

EVE E91BP-24 (570978)



**C Pictograms for School**

Kit of 245 magnetic pictograms to help you plan a day at elementary school or preschool. Size of the pictograms: 4 x 4 cm with rounded corners. Perfect for teachers, special educators and school staff. This product mainly helps children with special needs aged 5 years +.

IDO 829523 (829523) french

IDO IDEOSCHOOL (829522) english





**A** 



**B**  

**A Ring Binder**

Vinyl. D rings. Clear pockets on front, spine and back. 2 pockets includes inside.

- 1 in.**
- GCICV10LBE** (225094) light blue
- GCICV10LGN** (225110) light green
- GCICV10OR** (225169) orange
- GCICV10PK** (225177) pink
- GCICV10RD** (225185) red
- 1-1/2 in.**
- GCICV15LBE** (225193) light blue
- GCICV15LGN** (225201) light green
- GCICV15OR** (225219) orange
- GCICV15PK** (225227) pink
- GCICV15RD** (225235) red



**C**  



**D** 

**B Ring Binder**

Slanted D rings. Clear inside pockets. Full-width label on spine. Assorted colours.

- RG023061-6** (584110) 1 in. (225-sheet capacity)
- RG023062-6** (584102) 1.5 in. (350-sheet capacity)
- RG0 23064-6** (584094) 2 in. (475-sheet capacity)

**C Ring Binder**

PVC free binder. Features clear interior pocket on front and back covers to secure loose documents and allow for easy identification of content. Full width label holder on spine. Round ring. 1-1/2 in. Made in Canada.

- RG0231200** (544940) white
- RG0231201** (523266) black
- RG0231203** (523274) red
- RG0231204** (534685) green
- RG0231205** (523282) yellow
- RG0231208** (523290) burgundy
- RG0231292** (534743) royal blue



**E** **FIVE STAR**  
★★★★★



**F** 

**D ZipTote Ring Binder**

Sturdy nylon. Zippered closure. 2 in. capacity. Assorted colours. **HLR 29802** (724062)

**E Five Star Ring Binder**

Binder with front pocket. Exterior zipper pocket made from soft faux neoprene material. Interior organizational panel with puncture resistant micro-mesh zipper pocket. 2 in. Round rings. 12 x 2-1/2 x 13-3/4 in. Assorted colours. **HLR 28080** (1002849)



**G** 



**H**  

**F Dividers**

Polypropylene. Inside pocket. Pastels colours. **GCIIP115A** (226340) 5 tabs **GCIIP118A** (226357) 8 tabs

**G Big Tab™ Write & Erase Plastic Dividers**

Durable plastic. Write, erase and re-use. Letter size. PVC free. Assorted colours. **AVE16170** (787598) 5 tabs **AVE16171** (787606) 8 tabs

**H PageX™ Transparent Page Holders**

Polypropylene. Non-stick and no ink transfer. Colours will not fade. Archival quality. Acid-free. Non-glare. Heavyweight 0.003 in. Letter size. Box of 100. **GMXPP3119** (629279)



**I** 



**J** 

**I Expanding Binder Pocket**

Polypropylene. Zippered. 3-hole punched. Expansion of 1/2 in. 100-sheet capacity. Letter size. 10 1/2 x 11 4/5 in. Package of 3. Clear. **CRD14201** (1038199)

**J Large Protective Envelope**

Horizontal plastic envelope with zipper closure. 13 x 10 in. Clear. **GCI G007** (1002245)

## A Report Cover

Laminated cardstock. 2 inside pockets. Business card holder. 80-sheet capacity. Letter size.

- GCI34400BE** (758300) light blue
- GCI34400BK** (758318) black
- GCI34400DBE** (758326) royal blue
- GCI34400DGN** (758334) dark green
- GCI34400GN** (758342) green
- GCI34400GY** (758359) grey
- GCI34400OR** (758367) orange
- GCI34400PE** (758375) purple
- GCI34400PK** (222513) pink
- GCI34400RD** (758383) red
- GCI34400TE** (758391) turquoise
- GCI34400WH** (758409) white
- GCI34400YE** (758417) yellow



## B Report Cover

Plastic with inside pockets. 3-hole punched. Assorted colours. **GCI PFPL3P** (582296)



## C Report Cover

Lightly-textured cardboard. 3 fasteners. Letter size.

- HLR06203** (222778) orange
- HLR06204** (3384) yellow
- HLR06209** (222786) dark blue
- HLR06211** (222802) light grey
- HLR06212** (222794) white
- HLR06224** (222810) green
- HLR06226** (222828) light blue
- HLR06235** (222844) black
- HLR06237** (3392) red
- HLR06249** (419291) assorted colours



## D Report Cover

Plastic. 3 fasteners. 2 pockets. Snap button closure. Assorted colours. **GCI33000** (106898)

## E Dry Erase Pockets

Wipes clean with a soft dry cloth or tissue when used with a dry-erase marker (sold separately). Clear on both sides. 9 x 12 in. Package of 10. Assorted colours.

**RG040110** (1038851)

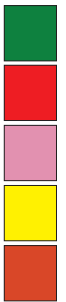

## F Clipboard

Polypropylene. Letter size.

- GCI246967** (246967) light blue
- GCIPCB14811GN** (246975) green
- GCIPCB14811OR** (246991) orange
- GCIPCB14811PK** (247007) pink
- GCIPCB14811RD** (247015) red
- GCIPCB14811YE** (246983) yellow

## G Windowfile™ Expanding File

Flap with elastic tie and button closure. Index tabs with inserts. Clear window on top of flap. Letter size. Assorted colours.

**WNN20140** (351403) 7 pockets

**WNN201V-12-AD** (765347) 13 pockets



## H 7-Pocket Expandable File

Polypropylene. With blank, A-Z and monthly tab inserts.

Flap and cord closure. Letter size. Assorted colours.

**PFXE55633** (270561)

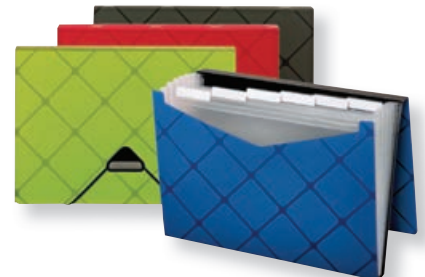

# ARTIST'S CORNER

ARTS AND CRAFTS ESSENTIALS FOR THE HOME AND OFFICE



REFERENCE	PRODUCTS	DESCRIPTION	DIMENSIONS	PRICE
A)	STX 00480E06C	Paint and Water Tray, white	8" x 8" x 3"	
B)	STX 63202D05C	Project box, assorted colours	15.25" x 13.25" x 3.25"	
C)	STX 61656B01C	Quickstack, 6-compartment, multicolour	20.5" x 13.62" x 8.75"	
D)	STX 00440E12C	Activity Tray, assorted colours	16.25" x 12.25" x 1.125"	
E)	STX 00940B06C	Small caddy, assorted colours	9.25" x 9.25" x 5.25"	





**A Plastic Caddy**

Made from impact resistant plastic. Comfort grip handle.  
2 compartments. 13 x 11 x 6-3/8 in. H. Assorted colours.  
**STX 00948B06C** (428037)



**B Classroom Caddy**

High quality plastic construction ensures strength and durability.  
3 compartments: one large and two small. Rounded handle fort comfort. Completely washable and dishwasher safe. 5.3 x 9.3 x 9.3 in.  
Pack of 5. Assorted colours.  
**STX 00941U06C** (1027846)

**C Classroom Storage Bin**

Easy-to-grip handles ensure firm grasp for safe transportation.  
Impact-resistant plastic provides long-lasting use. Stackable design offers space-saving storage options. Perfect for organizing rooms, holding supplies and more. 15 L. 13.6 x 11.25 x 7.9 in.  
**STX 61451U06C** (1027879) blue  
**STX 61452U06C** (1027895) red  
**STX 61453U06C** (1027903) yellow  
**STX 61480U06C** (1027887) green



**D Small Cubby Bin**

Standard size bin fits into most classroom furniture. Organizes art supplies, crafts, toys and small books. 5.25 x 12.25 x 8 in.  
**With clear lid**  
**STX 62737U05C** (828119) red  
**STX 62735U05C** (828116) blue  
**STX 62736U05C** (828117) green  
**STX 62738U05C** (828118) yellow  
**Without lid**  
**STX 62739U05C** (828114) assorted colours



**E Book Bin**

Made of sturdy and drop resistant plastic. Sides of bins connect together for safe storage. The handles are perfectly sized for big and small hands. The bin depth is 12 in. Assorted colours.  
**Sold by each**  
**STX 70113B06C** (427971) 11-3/4 x 4-1/2 x 8-1/2 in.  
**STX 70110U06C** (428979) 14-1/4 x 5-1/4 x 7 in.  
**Package of 5**  
**STX 70105U06C** (686089) 14-1/4 x 5-1/4 x 7 in.



**F Project Storage Boxes**

Ideal to hold craft supplies for any hobby. Fits standard sized scrapbooking papers. 12 x 12 in. Pack of 5. Assorted colours.  
**STX 63202D05C** (832400)



**G Stackable Caddy Organizer**

Includes white frame and three clear containers (1 small, 1 medium, 1 large). Multiple units can be stacked and locked. Snap-tight lids.  
**DEF 29003** (833017)  
• **Stack 'N Go Caddy Wheel Base**  
**DEF 29443CR** (833099)





**A** **STOREX**



**B** **STOREX**

**A Storage Box**

Plastic. Lightweight and stackable. No lid. 17-1/4 x 14-1/4 x 10-1/2 in. H. For letter/legal filing. Black.  
**STX61788U03C** (829711)

**B Storage Box with Lid**

Accommodates both letter and legal hanging files and folders. Moisture resistant. Lid snaps on securely. 18-3/8 x 13-7/8 x 10-1/2 in.  
**STX61528B04C** (829708) black  
**STX61508B04C** (829707) clear

**C Onyx™ Mobile File Cart**

Durable mesh material with tubular steel frame. Letter size filing drawer. 2 storage drawers. Top shelf stores additional supplies. On casters, 2 locking. Black powder coat finish.  
**SAF5213BL** (134098)

**D Scout™ Single Side Book Cart**

Steel construction. 3 slanted shelves, with 12-1/4 in. high shelf clearance. On casters, two locking. Black powder coat finish. 33 x 14-1/4 x 44-1/4 in. Greenguard certified.  
**SAF5336BL** (1055194)

**E STOW AWAY® Mobile Crate**

Efficiently transports files, binders, tools safely and securely. Fold down to 3-1/2 in. thick. Provides 1.2 cubic feet and 50 lb capacity. 16-1/2 x 14-1/2 x 18 in. H. Black.  
**SAF4054BL** (238840)

**F EZ Link® Stackable DocuPocket®**

Letter size. Black.  
**DEF73204** (100248) single file  
**DEF73604** (100255) 3-file set

**G Wall Clock**

12/24 hr. display with glass. 12 in. diameter. Quartz precision. Uses 1 AA battery, not included. Black.  
**GC181298** (789305)



**C** **SAFCO**



**D** **SAFCO**



**E** **SAFCO**

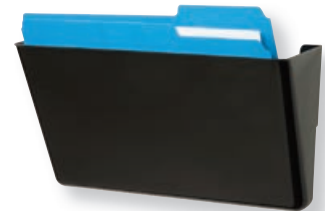

**F** **deflecto**



**G** **GEO**

## A Decorative Magazine Files

To store magazines, periodicals and folders. Letter size. 4-1/4 x 11-3/8 x 12-7/8 in. H. Package of 6 colours: orange, yellow, red, green, blue and purple. 60% recycled content. SFI certified.

FEL3381901 (235150)



## B Value Line Magazine Files

Made of 100% recycled plastic. Package of 2. Black. STX70168U06C (543165)

## C Large Bin

For storing large books, magazines, files, etc. Sides attach to each other for secure storage. Made of drop-resistant plastic. Handles on both sides for easy grip, even with small hands. Clear labeling pockets included. 14.3 x 5.3 x 7 in. H. Black.

STX70109U06C (596973)



## D Horizontal File

All steel. 6 inclined trays. Rubber base. Letter size. 12 x 9-1/2 x 13-1/4 in. Black.

SAF3128BL (555961)

## E Optimizers™ 2-Way Organizer

Rounded tiered design allows for easy file access. Stands upright or lays flat for various filing options. 5 letter size compartments. Clear. RUB94610R0S (115899)

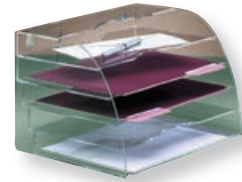

## F Revolving Desk Organizer

Spins like a Lazy Susan to keep your frequently used desktop tools and accessories within easy reach. Smooth finish resists scratches and marks to preserve its sleek appearance. Desk organizer is perfect for holding pencils, pens, markers, highlighters and more. Accessories not included. Black.

ACM81010 (391318)



## G Magnetic Paper Clip Dispenser

Magnetic top keeps paper clips easily accessible. Removable top and translucent base. Compact. Black and clear.

ACC72351 (415349)

## H Interlocking Tilt Bins

Modular units feature an interlocking design allowing you to mix and match sizes. Clear, removable bins keep supplies visible. Mounting hardware and labels included. Can also be mounted on cubicle walls with partition brackets (not included).

5 compartments

DEF205040P (311159) 23-5/8 x 5-1/4 x 6-1/2 in. H.

6 compartments

DEF206040P (311167) 23-5/8 x 3-5/8 x 4-1/2 in. H.



## I Plastic Rectangular Wastebasket

Black. 100% recycled content.

STX00710U06C (425215) 14-1/4 x 10-1/4 x 15 in. H.

STX00700U04C (425223) 15-1/4 x 11 x 20 in. H.

## J Recycling Wastebasket

Blue.

RUB295573BLUE (336461) 12.9 L

RUB295673BLUE (460691) 26.6 L.





**A Rainbow Pebbles**

Toddlers will build their fine motor skills when stacking these odd-shaped, plastic pebbles. They can sort and sequence them. Includes 36 pieces (3 sizes and 6 different colours). For age 18M+  
**LAD 13228** (833120)

**B Letters & Numbers Mini Jar**

Contains 36 pieces of transparent plastic letters and numbers which are ideal for learning the order of the alphabet and numbers from 0 to 9. Size: 2 in. H. Assorted colours. For age 3+  
**LAD 56500** (833123)

**C Sensory Texture Balls**

Set of 6 balls which have different colours and textures for little baby. Size: 2.4 in. diameter. For age 6M+  
**LAD 74058** (833125)

**D Rainbow Architect Arches**

Made of natural wood. This game allows toddlers to explore color, shape and balance while developing fine motor skills. 12M+.  
**LAD 73412** (833124)

**E Easy Hold Discovery Set**

A 6-piece set allows children to view the world differently. Includes transparent acrylic in red blue and yellow, one magnifying lens, a two-sided convex/concave mirror and a plane mirror. Frame size: 7.25 x 4.75 x 0.75 in. For toddlers 12M+.  
**LAD 933373382** (833127)

**F Colour Match Game**

To teach toddlers how to count, sort and classify. Includes 12 eggs with a matching number of holes and colours in the center when pulled apart. For age 18M+  
**LAD 74064** (833126)



**G Caterpillar Activity Wall Panels**

Set of 5 panels. Includes a colour-mixing wheel, rotational pieces, bead wheel, etc. Allows toddlers to develop motor, collaborative play and initiate them to learn colours. Each panel has its own fixing holes and screws. Constructed with MDF. Size of 5 mounted panels: 6 ft 3 in. L x 2 ft 7 in. H.  
**LAD 44557** (833121)

**H Crocodile Activity Wall Panels**

Set of 5 panels. Includes percussive instruments, mirror, magnetic pen and balls, mini mazes, etc. Allows toddlers to develop motor, collaborative play and early math skills. Each panel has its own mounting holes and screws. Constructed with MDF. Size of 5 mounted panels: 6 ft. 2 in. L x 24 in. H.  
**LAD 50346** (833122)



**A Triangle Grip Stampers**

Set of 4 stampers with different patterns: flower, spiral, star and splash. Rubber handles. For age 24M+.  
**LAD CE6678** (833128)



**B Giant Stampers**

Size: 1.9 in. H. x 3 in. diameter.  
**LAD CE6769** (833132) wild animals (6 stampers)  
**LAD CE6739** (833130) farm animals (10 stampers)  
**LAD CE6749** (833131) imaginative play (10 stampers)  
**LAD CE6725** (833129) Christmas (10 stampers)



**C Stamp Pads**

Washable. Non-toxic. Quick drying ink. Fade resistant and acid-free for archival quality. Each ink pad is 5.75 in. diameter. 3 year +  
**4 stamps: yellow, green, blue and red**  
**LAD CE6616** (833134)  
**10 stamps: yellow, orange, green, blue, red, black, purple, pink, brown and silver**  
**LAD CE6615** (833133)

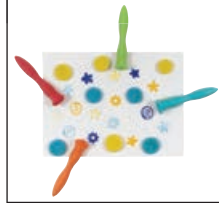

**A**

**B**



**D Alphabet Animal Flash Cards**

Educational cards to learn the letters of the alphabet. Contain 27 erasables cards and one marker. 4 yrs +.  
**LPR SL15427** (833103)

**E Flash Cards**

Includes 35 double-sided flashcards, plus a card with game ideas to make learning fun. French.  
**LMA 797588** (829580) alphabet  
**LMA 797589** (829581) multiplications  
**LMA 797590** (829582) additions  
**LMA 797591** (829583) numbers



**C**

**D**



**F Headphones for Kids**

On-the-ear design, sized for kids and featuring a volume limiter.  
**JVC HA-KD7-PN** (424135) pink/violet  
**JVC HA-KD7-YN** (424143) yellow/blue



**G Wireless On-Ear Headphones for Kids**

Child safe with built-in volume limiter (85dB 1mW). Up to 16hrs listening on a single charge. 7-step length adjuster for best fit. Comfortable and easy-to-clean soft ear pads and wide headband for customizing with included fun stickers. Built-in mic for E-Learning. Ages 3+.  
**JVC HA-KD10W-P** (828393) pink and violet  
**JVC HA-KD10W-Y** (828394) yellow and blue

**E**



**F JVC**



**G JVC**





All these Mytibilt products are made or assembled in Canada

**MITYBILT**



**A**



**A Activity Table**

Adjustable legs 22 to 30 in. High pressure laminate. 3 mm edge band. Powder coated legs. Limited lifetime warranty. Greenguard certified.

**Rectangle**

**MYB AT2448** (833215) 24 x 48 in.

**MYB AT2460** (833216) 24 x 60 in.

**MYB AT3060** (833217) 30 x 60 in.

**Trapezoid**

**MYB AT2448Z** (833213) 24 x 48 in.

**MYB AT3060Z** (833214) 30 x 60 in.

**C-shape**

**MYB AT3660C** (833218) 30 x 60 in.

**MYB AT4872C** (833219) 48 x 72 in.

**B Conekt Linx Eko Table**

Adjustable legs 22 to 30 in. High pressure laminate. 3 mm edge band. Powder coated legs. Limited lifetime warranty. Greenguard certified. 24 x 48 in.

**MYB EEKO-AH** (833221)

**C Conekt Linx Surf Table**

Adjustable legs 22 to 30 in. High pressure laminate. 3 mm edge band. Powder coated legs. Limited lifetime warranty. Greenguard certified. 30 x 48 in.

**MYB ESURF-AH** (833220)

**D RTA Rectangle Table**

Fixed height 29-1/2 in. High pressure laminate. 3 mm edge band. Powder coated legs. Limited lifetime warranty. Greenguard certified.

**MYB RTA2460** (833229) 24 x 60 in.

**MYB RTA3060** (833230) 30 x 60 in.

**E Adjustable Marker Board Flip Top**

Premium flip top mechanism. One hand operation. Locks in horizontal and vertical position. Adjustable height 30 to 42 in. High pressure laminate. 3 mm edge band. Powder coated frame. Limited lifetime warranty. Certified GreenGuard Gold.

**MYB 833222** (833222) 24 x 60 in.

**MYB 833223** (833223) 30 x 60 in.



**B**



**C**



**D**



**E**



## A Rave Rocking Chair

Gently curved sled base rocking frame provides an active sitting position. One piece molded seat shell. Stainless steel frame. Limited lifetime warranty. Blue. Assembled in Canada.

**MYB RR12** (833235) 12 in. H seat  
**MYB RR14** (833236) 14 in. H seat

**MITYBILT**



## B Rave Chair

Unique design allows for four different seating positions. One piece molded seat shell. Stainless steel frame. Limited lifetime warranty. Blue. Assembled in Canada.

**MYB RV12-NVY** (833231) 12 in. H seat  
**MYB RV14-NVY** (833232) 14 in. H seat  
**MYB RV16-NVY** (833233) 16 in. H seat  
**MYB RV18-NVY** (833234) 18 in. H seat

## C Sonic Book Box Student Desk

Adjustable height 22 to 30 in. Maple laminate. Charcoal edging. Powder coated frame. Plastic book box. Limited lifetime warranty. Assembled in Canada. 18 x 24 in.

**MYB SD1824** (833224)

## D Zenith Book Box Student Desk

Adjustable height 22 to 30 in. Maple laminate. Charcoal edging. Powder coated frame. Steel book box. Limited lifetime warranty.

**MYB ZD1824BBAH** (833225) 18 x 24 in.  
**MYB ZD2026BBAH** (833226) 20 x 26 in.

## E Zenith Lift Lid Student Desk

With opening top. Adjustable height 22 to 30 in. Maple laminate. Charcoal edging. Powder coated frame. Steel book box. Limited lifetime warranty.

**MYB ZD1824LLAH** (833227) 18 x 24 in.  
**MYB ZD2026LLAH** (833228) 20 x 26 in.



**A**

**B**



**C**

**D**

**E**



**A** **LORELL**



**A Fortress Double Pedestal Desk**

Features 2 box/file pedestals with full extension ball bearing slides, locking centre drawer and integrated drawer pulls. 60 x 30 x 29.5"H.  
**LLR 60927** (1016187) black/walnut  
**LLR 60926** (1016211) oak/putty  
**LLR 60928** (1016203) mahogany/charcoal  
**LLR 60935** (1016195) grey

**B Fortress Single Pedestal Desk**

Features 2 box/file pedestals with full extension ball bearing slides, locking centre drawer and integrated drawer pulls. Right pedestal.  
 45-1/2 x 24 x 29-1/2 in. H  
**LLR 66948** (1016229) walnut/black  
**LLR 66947** (1071067) oak/putty  
**LLR 66949** (1071075) mahogany/charcoal  
 48 x 30 x 29-1/2 in.H  
**LLR 66902** (1016179) walnut/black  
**LLR 66908** (1016328) oak/putty  
**LLR 66903** (1016310) mahogany/charcoal

**C Teachers Desk**

Teachers desk with pedestal on the right. Durable high performance laminate top. 48 x 30 x 29-1/2 in. H.  
**LLR 66939** (1016253) walnut/black  
**LLR 66940** (1016260) white/platinum

**D BookSTOR Mobile Bookcase**

Locking swivel heavy-duty casters. Integral handle. Fully welded chassis. Adjustable shelves. Metal back panel. Limited lifetime warranty. GreenGuard Gold Certified. 42 X 42 in.  
**MYB BS4242** (833237) straight  
**MYB BSC4242** (833238) curved

**E Scout™ Single Side Book Cart**

Steel construction. 3 slanted shelves, with 12-1/4 in. high shelf clearance. On casters, two locking. Black powder coat finish. 33 x 14-1/4 x 44-1/4 in. Greenguard certified.  
**SAF 5336BL** (1055194)



**B** **LORELL**



**C** **LORELL**



**D** **MITYBILT**



**E** **SAFCO**



## A Whiffle Storage Cart

Versatile design that includes an HPL work surface, dry-erase laminate on the back, and storage. 3/4"-thick particleboard with thermal-fused laminate on both sides. Powder-coated frame. Three-inch trays. Four heavy-duty, 360-degree swivel casters (2 locking).

**4 trays - 16-1/2 x 19-3/4 x 27-1/4 in. H**

SAF 3921GRY (833195) grey

SAF 3921RED (833196) red

SAF 3921SBU (833197) blue

**4 trays with locking door - 16-1/2 x 19-3/4 x 27-1/4 in. H**

SAF 3926GRY (833204) grey

SAF 3926RED (833205) red

SAF 3926SBU (833206) blue

**4 shelves - 30 x 19-3/4 x 48 in. H**

SAF 3923GRY (833201) grey

SAF 3923RED (833202) red

SAF 3923SBU (833203) blue

**4 shelves and 10 trays - 30 x 19-3/4 x 48 in. H**

SAF 3922GRY (833198) grey

SAF 3922RED (833199) red

SAF 3922SBU (833200) blue

**30 trays - 43-1/4 x 19-3/4 x 48 in. H**

SAF 3930GRY (833207) grey

SAF 3930RED (833208) red

SAF 3930SBU (833209) blue

**12 shelves - 43-1/4 x 19-3/4 x 48 in. H**

SAF 3931GRY (833210) grey

SAF 3931RED (833211) red

SAF 3931SBU (833212) blue



## B SystemSTOR Metal Storage Unit

Fully welded steel frame. Steel top shelf. Locking swivel castors. Durable powder coat finish. Shatterproof trays with smooth surfaces for easy cleaning. Ships fully assembled complete with 9 trays. 16 x 18 x 40-3/4 in. H. Limited lifetime warranty.

MYB SWM-9 (833241)



## C SystemSTOR Wood Storage Unit

3/4 in. maple wood tone cabinet sealed with maple edge band. Locking swivel castors. Durable powder coat finish. Shatterproof trays with smooth surfaces for easy cleaning. Ships fully assembled complete with trays. Limited lifetime warranty.

**41-1/2 x 18-3/4 x 27-1/2 in. H**

MYB SWW-18T (833239)

**43-1/2 x 18-3/4 x 38-3/4 in. H**

MYB SWW-30 (833240)



## D Mobile Storage Cabinets with Bins

Made with durable and sturdy steel. Includes 16 clear bins. Each bin is 3 in. H. On casters. Contains 28% recycled content. Covered by Lorell limited lifetime warranty.

**15 x 18 x 36 in. H**

LLR 71104 (1020346) black

**30 x 18 x 36 in. H**

LLR 71101 (1020320) black

LLR 71102 (1020965) platinum



# A

# B

A/V Kits.....	17
Access Points.....	83-85
Accordion File Pockets.....	483-484
Account Books.....	451-452
Acrylic Paints.....	636
Adapters.....	74-75, 77, 85-87, 92, 206
Address Labels.....	473-474
Adhesives.....	565-566
Admission Tickets.....	285
Air Dusters.....	72
Air Fresheners.....	350-351
Air Horns.....	323
Air Purifiers / Filters.....	252, 353
Alcohol Antiseptic Wipes.....	328
Alkaline Batteries.....	97, 99
All Purpose Cleaners.....	72, 356-357
All Purpose Glues.....	566, 642, 665
Aluminum Clipboards/Form Holders.....	533-534
Aluminum Containers.....	312
Aluminum Foil.....	312
Anti-Fatigue Mats.....	161, 383
Art Board Carry Cases.....	647
Art Erasers.....	649
Art Tapes.....	642-643

Back Rests.....	70
Backer Boards.....	400
Backpack Pouches.....	482
Backpacks.....	221, 223-224, 227,229
Badge Clips / Reels.....	283

## BAGS

- Crossbody Bags.....	223, 229
- Deposit Bags and Wallets.....	152-153
- Duffel / Sports Bags.....	223
- Garbage Bags.....	379-381
- Kitchen Garbage Bags.....	379
- Messenger Bags.....	225
- Resealable Bags.....	312, 400
- Shredder Bags.....	120
Ballpoint Pens.....	589, 596-604, 668-669
Bandages.....	327
Banquet Chairs.....	204-205
Barrier Tapes.....	323
Bathroom Cleaners.....	358
Batteries, Chargers.....	97, 99
Beads.....	641
Beverage Bottles.....	306
Beverage Pods.....	294-296
Bill Counters.....	151

## BINDERS

- 3-Ring Binder Cases.....	220, 676
- Cheque Binders.....	509
- Customizer Binders.....	506-507
- Data Binders.....	531
- Heavy Duty Binders.....	501-503
- Ledger Size Binders.....	509
- Legal Size Binders.....	508
- Pockets.....	510-511, 676
- Presentation Binders.....	530
- Small Size Binders.....	508
- Standard Binders.....	504-505, 676
Binder Label Holders.....	511

Binder Pockets.....	510-511, 676
Binder Punches.....	547
Binding Cases.....	494
Binding Covers and Combs.....	142-143
Binding Machines.....	140-141
Blade Disposal Boxes.....	555
Blankets.....	331
Bleaches.....	360
Bluetooth Trackers.....	34

## BOARDS

- Bulletin Boards.....	168
- Calendar/Planning Whiteboards.....	259
- Chalkboards.....	265
- Combination Boards.....	267
- Cork Boards/Panels.....	266, 268
- Fabric Boards.....	267
- Glass Boards.....	257-258
- High Density Foam Boards.....	266

- IN/OUT Boards.....	261	- Pencil/Crayon Boxes.....	639	Calculator Ribbons.....	132-134
- Mobile Whiteboards.....	262	- Plastic Caddy Boxes.....	678-679	Calculator Rolls.....	421
- Porcelain Whiteboards.....	259, 674	- Plastic Storage Boxes, Totes and Crates.....	495-496, 680	Calculators.....	132-139, 667
- Project Boards.....	265	- Printed Shipping Boxes.....	396	Calendar Whiteboards.....	259
- Sandwich Sign Boards.....	277	- Raffle Boxes.....	285	Call Bell.....	285
- Whiteboards.....	249, 259-261, 674	- Rolling File Boxes.....	496, 680	Candies.....	302
Board Cleaners.....	258, 263	- Secure File Boxes.....	216	Canvases.....	636
Board Easers.....	258, 263, 265, 674	- Suggestion Boxes.....	285	Carafes.....	290, 306
Board Markers.....	620-622, 674	- Tool Kits/Boxes.....	367	Card Page Protectors.....	522-523
Body Wash.....	333	- Toy Boxes.....	656	Card Reader Cleaning Cards.....	421
Book Bins.....	679	Briefcases.....	225-231	Cardstock.....	413-414, 645
Book Carts.....	680, 686	Bristol Paper.....	645	Cardstock Envelopes.....	391
Book Holders.....	61	Brochure Paper.....	419	Carpet Cleaners.....	361
Book Rings.....	573	Brooms and Hooks.....	369	Carpet Tape.....	572
Book Tape.....	570	Brushes.....	364, 638	Cartridge Paper.....	645
Bookcases.....	175, 686-687	Bubble Wrap.....	399	Carving Sets.....	313
Bookends.....	241	Buckets.....	366	<b>CASES</b>	
Boot Trays / Racks.....	382	Bulbs.....	254	- Art Board Cases.....	647
Bottled Water.....	300	Bulldog Clips.....	576	- Binder Cases.....	220, 494, 676
Bowls.....	310, 313	Bullet Tip Markers.....	624-627, 663, 673	- Briefcases.....	225
Box Cutters.....	554	Bulletin Boards.....	168, 249, 266-268	- Fashion Cases.....	223, 230-231
<b>BOXES</b>		Business Card Holders.....	239	- Jewel Cases and Boxes.....	47
- Blade Disposal Boxes.....	555	Business Cards.....	417	- Laptop Cases.....	224-225
- Cash Boxes.....	154			- Pencil Cases.....	649
- Coin Collection Boxes.....	285	Cables.....	35, 73-77, 93	- Pilot Cases with Wheels.....	227
- Corrugated Boxes.....	396	Caddy Boxes.....	678-679	- Smartphone Cases.....	32-34
- Exterior Literature Boxes.....	271			- Suitcases.....	228
- Index Card Files/Boxes.....	489			- Telescoping Tube Cases.....	647
- Inter-Office Mailboxes.....	404			Cash Boxes / Pouches.....	153-153
- Jewel Cases and Boxes.....	47			Cash Register Rolls.....	421
- Lock Boxes.....	563			Cash Trays.....	154

Casters.....	193, 207	<b>CLEANERS</b>	Colouring Books.....	653, 656	
Catalogue Cases.....	227	- All Purpose Cleaners.....	72, 356-357	Colouring Markers.....	651-653, 655-656
Catalogue Envelopes.....	388-389, 661	- Bathroom Cleaners.....	358	Colouring Mats.....	640, 647
CDs/DVDs, Sleeves and Writers.....	46-47	- Board Cleaners.....	258, 263	Columnar Books.....	451
Certificate Frames and Paper.....	422-423	- Carpet and Upholstery Cleaners.....	361	Combination Boards.....	249, 267
<b>CHAIRS</b>		- Disinfecting Cleaners.....	356-358	Combination File Sorters.....	244
- 24-Hour Chairs.....	180	- Floor Cleaners.....	361	Combination Filing/Storage Cabinets.....	212-213
- Banquet Chairs.....	204-205	- Furniture Cleaners/Polishes.....	359	Combination Padlocks.....	563
- Classroom Chairs.....	685	- Glass and Window Cleaners.....	359	Compass.....	550
- Club Chairs.....	198-200	- Pipe Cleaners.....	641	Compostable Garbage Bags.....	379
- Executive Armchairs.....	178-180	- Screen Cleaners and Kits.....	72	Conference Kits.....	17
- Folding Chairs.....	203	- Toilet Bowl Cleaners.....	358	Construction Paper.....	644-645
- Guest Chairs.....	189-191, 200	Cleaning Cloths.....	72	Continuous Form Paper.....	420
- Operator Chairs.....	180-185	Clipboards.....	532-534, 677	Convertible Backpacks.....	223-224, 227, 229
- Task Chairs.....	186-188	Clips.....	248	Cookies.....	305
Chair Dollies.....	205	Clocks.....	155, 255, 675	Coolers.....	292
Chair Mats.....	194-195	Clothing Labels.....	479	Copy Holders.....	61
Chair Slippers.....	193	Coat Check Tickets.....	285	Cord Concealer.....	77
Chalk.....	265, 640	Coat Stands and Hooks.....	201, 249	Cork Boards/Panels.....	266, 268
Chalkboards.....	265	Coding Labels.....	474, 478	Corporation Record Books.....	455
Chargers.....	32, 36-37, 93	Coffee.....	294-297	Correction Fluids and Tape.....	617-618, 670
Charging Cables.....	35, 76	Coffee Makers / Warmers.....	290-291	Correspondence Paper.....	412
Cheque Binders.....	509	Coffee Tables.....	200	Correspondence Trays.....	234-236
China Markers.....	630	Coffee Whitener.....	298-299	Corrugated Boxes.....	396
Chisel Tip Markers.....	627-628	Coil Bound Notebooks.....	425-430, 660	Cotton Balls.....	238
Clamp Lamps.....	253-254	Coin Collection Boxes.....	285	Couches.....	198-199
Classification Folders.....	461-462	Coin Envelopes.....	389	Counter Pens.....	604
Classification Hanging Folders.....	470	Coin Sorters.....	151	Counterfeit Detectors.....	151
		Coin Tubes / Rollers.....	153	Cover Stock.....	413-414
		Cold Drinks.....	301		
		Coloured Pencils.....	616, 649-650, 671		

CPR Kits.....	330	Desk Shells .....	168	Document Frames.....	248
Crates.....	495-496, 680	Deskside Waste Containers.....	375, 681	Document Pockets.....	480
Crayon Boxes.....	639	Desktop Sit-Stand Converters.....	64-65	Document Sorters/Organizers.....	
Credenzas.....	168	Dictionaries.....	662	.....	248, 480
Crossbody Bags.....	223, 229	Digital Projectors.....	19	Dollies.....	202, 208, 211, 378, 405
Cubby Bins.....	678-679	Dish Detergents.....	357, 362-363	Door Stoppers .....	323
Cup Dispensers.....	306	Disinfectants and Dispensers.....		Double-Sided Tape.....	572
Cup Sleeves.....	308	.....	337-339	Drafting Stools.....	192
Cups.....	306-308	Disinfecting Cleaners.....	356-358	Drafting Templates.....	643
Cushion Wrap.....	400	<b>DISPENSERS</b>		Drain Clog Removers.....	363
Cushions.....	70	- Cup Dispensers.....	306	Drawer Organizers.....	238
Custom Nameplates.....	279, 578	- Disinfectant Dispensers .....	337-338	Drawing Sets.....	649
Custom Stamps.....	579-581	- Hand Soap Dispensers.....	335-336	Dressings and Supplies.....	328
Cutting Mats.....	555	- Kraft Paper Roll Dispenser .....	399	Dry Mops and Refills.....	371-372
		- Napkin Dispensers.....	315	Dry-Erase Board Easels.....	269
		- Note Dispensers .....	446	Dry-Erase Boards.....	249
		- Office Tape Dispensers .....	571, 664	Dual USB Drives.....	44
		- Packaging Tape Dispensers .....	397	Duct Tape.....	572
		- Stretch Wrap Dispensers.....	402	Duffle Bags.....	223
		- Ticket Dispensers.....	285	Durable Index Tabs.....	446
		- Toilet Seat Cover Dispensers.....	348	Dusters .....	366
		- Toilet Tissue Dispensers.....	348	Dustpans.....	369
		- Towel Dispensers .....	342, 345		
		- Water Coolers/Dispensers.....	292		
Daily Dated Planners.....	440	Display Racks.....	271-272, 309		
Data Binders.....	531	Disposable Gloves.....	316		
Data Cartridges.....	47	Disposable Wipers.....	365		
Daters .....	581-583	Dividers.....	206-207, 512-518		
Decanters.....	306	Docking Stations.....	94	Earmuffs.....	322
Decongestants .....	332	Document Corners.....	455	Earplugs.....	322
Deodorants.....	333	Document Fasteners.....	573	Electric Pencil Sharpeners.....	559
Deposit Bags / Wallets .....	152-153				
Depository Safes.....	216				
Desk Lamps.....	252-253				
Desk Pads.....	246-247, 443				

# D

# E



## FOLDERS

- Box-Bottom Hanging File Folders.....	470
- Classification File Folders.....	461-462
- Classification Hanging Folders.....	470
- Fastener File Folders.....	461, 465
- File Folders.....	458-461, 464-465
- Hanging File Folders.....	468-469
Folding Chairs.....	203
Folding Tables.....	202
Follower Blocks.....	209
Food Containers.....	311
Footrests.....	71
Forks.....	310, 313
Form Holders.....	534
Fountain Pens.....	604
Furniture Cleaners/Polishes.....	359

# G

Games.....	657
Garbage Bags.....	379-381
Gauze Pads.....	328
Gel Ink Pens.....	589-595, 668
Geometry Sets.....	550, 639, 642, 667
Glass Board Magnets.....	258
Glass Board Markers.....	621, 623
Glass Boards.....	257-258

Glass Cleaners.....	359
Glitter Glue.....	640
Globes.....	667
Gloves.....	317

## GLUE

- All Purpose Glues.....	566, 642, 665
- Glitter Glue.....	640
- Glue Guns and Sticks.....	641
- Glue Rollers.....	565
- Glue Sticks.....	565, 642, 665
- Super Glues.....	566, 642
Glue Guns and Sticks.....	641
Golf Pencils.....	616
Graphing Calculators.....	135
Graphite Pencils.....	615-616, 663, 671
Grid Tape.....	264
Guest Chairs.....	189-191, 200
Guillotine Trimmers.....	552, 667
Gum.....	302

# H

Hairnets.....	320
Hand Lotions / Creams.....	333
Hand Soap.....	334-336, 338
Hand Soap Dispensers.....	335-336
Hand Trucks.....	405
Hanging Clamps.....	176

Hanging File Bars.....	206-207
Hanging File Folders.....	468-470
Hanging File Tabs.....	471
Hanging Folder Frames/Holders.....	472
Headsets.....	25-30, 150, 683
Health Bars.....	304
Hearing Aid Batteries.....	99
Heaters.....	354
Heavy-Duty Staplers.....	537-538
High Density Foam Boards.....	266
Highlighters.....	631-633, 673

## HOLDERS

- Binder Label Holders.....	511
- Book Holders.....	61
- Business Card Holders.....	239
- Certificate Holders.....	423
- Chalks and Holders.....	265, 640
- Copy Holders.....	61
- Desktop Sign Holders.....	279
- Disposable ID Badges/Holders.....	281-282
- Floor Sign Holders.....	277
- Form Holders.....	534
- Hanging Folder Frames/Holders.....	472
- Label Holders.....	511
- Magazine/Book Holders.....	240-241, 511, 681
- Magnetic Sign Holders.....	278
- Memo Holders.....	233
- Nameplate Holders.....	248-249, 279, 578
- Paper Clip Holders.....	233

- Reusable ID Badges/Holders.....	281, 578
- Shop Ticket Holders.....	523, 677
- Sign Holders.....	248-249, 277
- Stamp Holders.....	585
Hole Punches.....	545-548, 664
Hooks and Fasteners.....	569
Horizontal File Sorters.....	243, 681
Hospitality Carts.....	309
Hot Chocolate.....	298
Hot/Cold Packs.....	330-331
Hubs.....	75, 83, 93
Humidifiers.....	353
Hutches.....	168
Hydrogen Peroxide.....	328

## I

ID Badges/Holders.....	281-282, 578
ID Bracelets.....	284
Identification Labels.....	474, 478
Identification Shipping Tags.....	401
Illuminated Drawing Table.....	656
Illuminated Magnifiers.....	551
IN/OUT Boards.....	261
Income Tax Slip (T4) Envelopes.....	387
Index Card Files/Boxes.....	489
Index Cards.....	490

Indoor/Outdoor Mats.....	382-383
Industrial Labels.....	479
Industrial Markers.....	629
Inkjet Printer Paper.....	411-412
Insect Repellents.....	332
Insertable Tab Dividers.....	515
Inter-Departmental Envelopes.....	393
Inter-Office Mailboxes.....	404
Inter-Office Memos.....	454
Internal Hard Drives.....	41
Invisible Office Tape.....	570
Invitation Cards.....	417
Invitation Envelopes.....	387
Invoices.....	453
Iron.....	366
Isometric Grid Paper.....	644

## J

Janitor Caddies/Organizers.....	367
Janitor Carts.....	367
Jewel Cases / Boxes.....	47
Jiggly Eyes.....	641
Job Work Order Forms.....	454
Juices.....	300-301
Jumbo Toilet Tissue Rolls.....	347-348

## K

Kettles.....	291
Key Cabinets.....	561
Key Tags/Rings.....	561
Keyboard Drawers/Trays.....	59-60, 168
Keyboards.....	49-51
Kitchen Garbage Bags.....	379
Kitchen Towels.....	341
Knife Sheaths.....	555
Knives.....	310, 313, 553-555
Kraft Paper Roll Dispenser.....	399
Kraft Wrapping Paper.....	399

## L

### LABELS

- Clothing Labels.....	479
- Coding and Identification Labels.....	474, 478
- End-Tab Labels.....	466
- Envelope Sealing Labels.....	479
- File Folder Labels.....	463
- Industrial Labels.....	479
- Label Maker Labels.....	129
- Label Maker Tape Cartridges.....	129-131



- Labeling Gun Labels.....	287	Legal Exhibit Tabs.....	519	Magnetic Clips.....	577
- Media Labels.....	479	Legal Seals.....	455	Magnetic Sign Holders.....	278
- Merchandising Labels.....	476-477	Legal Size Binders.....	508	Magnetic Tape.....	264
- Multipurpose Labels.....	479	Legal Size Dividers.....	518	Magnetic Trays/Cups.....	264
- Printed Shipping Labels.....	402	Legal Size Page Protectors.....		Magnetic Wall Files.....	250-251
- Report Cover Labels.....	479	.....	520-521	Magnets.....	264
- Shipping and Address Labels..	473-474	Letter Openers.....	395	Magnifier Lamps.....	254
Label Holders.....	511	Letter Size Page Protectors.....		Magnifying Glasses.....	551
Label Maker Cleaning Card.....	128	.....	520-521, 676	Magnifying Rulers.....	551
Label Maker Labels.....	129	Letter Trays.....	234-236	Mail Carts.....	404
Label Maker Tape Cartridges.....	129-131	Letters.....	643, 665	Mailing Tubes.....	396
Label Makers.....	122-128	Lids.....	307-308, 377-378	Mailroom Sorters.....	404
Labeling Gun Labels and Supplies.....		Light Bulbs.....	254	Map Pins.....	268
.....	286-287	Lint Rollers and Refills.....	366	Maps.....	667
Labeling Guns.....	286	Lithium Batteries.....	97, 99	<b>MARKERS</b>	
Laminate Bookcases.....	175	Lobby Brooms and Kits.....	368	- Board Markers and Accessories Kits	
Laminating Film/Rolls.....	149	Lock Boxes.....	563	.....	620-622, 674
Laminating Pouches.....	147-149, 664	Lockers.....	213	- Bullet Tip Markers.....	624-627, 663, 673
Laminator Cleaning Supplies.....	147	Long Reach Staplers.....	542	- China Markers.....	630
Laminators.....	145-146, 664	Loose-Leaf Paper.....	437, 661	- Chisel Tip Markers.....	627-628
Lamps.....	252-254	Loveseats.....	198-199	- Colouring Markers.....	
Lanyards.....	284	Lubricants.....	120, 361	.....	651-653, 655-656
Laptop Cases.....	224-225	Luggage Padlocks.....	563	- Erasable Ink Markers.....	640
Laptop Computer Locks.....	38-39	Lumber Crayons.....	630	- Fine Line Markers.....	652
Laptop Sleeves.....	229			- Flipchart Markers.....	627
Laptop Stands/Risers.....	69			- Glass Board Markers.....	621, 623
Laser Printer Paper.....	411-412			- Industrial Markers.....	629
Lateral Filing Cabinets.....	206-208			- Needle Tip Markers.....	
Laundry Detergents.....	351, 360			.....	325, 627, 652, 663, 673
Learning Games.....	657	Magazine Holders.....	240-241, 511, 681	- Page Markers.....	444-445
Ledger Refill Pages.....	451	Magnet Sheets.....	418	- Paint Markers.....	630

# M



Paint Markers.....	630	Paper Clip Holders.....	233	Plates.....	310, 313
Paint Pots.....	638, 647, 678	Paper Clips.....	577, 667	Platform Truck.....	405
Paint Sticks.....	636	Parts Bins.....	396	Playhouses.....	656
Painters Tape.....	572	Pastels.....	648	Plier Staplers.....	543
Painting Set.....	657	Payroll Books.....	452	Pliers.....	367
Paints.....	635-637	Pedestals.....	168, 173-174, 210	Plungers.....	349
Palettes.....	638, 647, 678	Pen Refills.....	599, 610-611, 668	Pocket Calculators.....	139
Paper		Pen Style Highlighters.....		Poly Expanding Files.....	485-488, 677
- Brochure Paper.....	419	.....	631-632, 663, 672-673	Poly Tab Dividers.....	516-517, 676
- Cartridge Paper.....	645	Pencil Cases / Boxes.....	639, 649	Poly/Vinyl Envelopes.....	394, 676
- Certificate Paper.....	422	Pencil Cups.....	232-233, 248	Pompoms.....	641
- Construction Paper.....	644-645	Pencil Grips.....	671	Pop.....	301
- Continuous Form Paper.....	420	Pencil Sharpeners.....	559-560, 664	Pop-up Notes.....	447-448, 450, 661
- Correspondence Paper.....	412	Pens.....	588-610	Porcelain Whiteboards.....	259, 674
- Fingerprint Paper.....	644	Perfect Bound Notebooks.....		Portable Batteries.....	93
- Isometric Grid Paper.....	644	.....	425-429, 660	Portable Hard Drives.....	41-42
- Kraft Wrapping Paper.....	399	Personal Organizers and Refills.....	442	Postal Scales.....	403
- Laser and Inkjet Paper.....	411-412	Personal Shredders.....	115, 117, 119	Poster Board.....	645
- Loose-leaf Paper.....	437, 661	Petty Cash Vouchers.....	153	Potato Chips.....	305
- Medical Table Paper.....	331	Photo Albums.....	647	Power Bars.....	100-101
- Multipurpose Paper.....		Photo Page Protectors.....	522, 523	Pre-Moistened Wipes.....	355
.....	408-410, 415-416	Photo Paper.....	418	Pre-Printed Signs.....	275-276
- Newsprint Paper.....	645	Pilot Cases.....	227	Pre-Printed Tab Dividers.....	512, 516
- Newsprint Wrapping Paper.....	400	Pipe Cleaners.....	641	Precision Knives.....	555
- Notarial Paper.....	455	Pitchers.....	306	Presentation Binders.....	530
- Paper Cups.....	307-308	Place Cards.....	417	Presentation Books/Portfolios.....	
- Photo Paper.....	418	Plan Stands/Racks.....	176	.....	530, 647
- Sticker Paper.....	418	Planning Whiteboards.....	259	Presentation Easels.....	570
- Tracing Paper.....	647	Plastic Storage Boxes.....		Pressboard Guides.....	463
- Transfer Paper.....	419	.....	495-496, 680	Pretzels.....	305
- Wide Format Paper Rolls.....	420	Plastic Wrap.....	312	Printable Tab Dividers.....	513

Printing Calculators.....	132-134
Privacy Filters.....	21-22
Project Boards.....	265
Project Sorter.....	480
Projection Screens.....	19
Prong Fasteners.....	573
Protractors.....	550, 667
Punch Heads.....	545-547, 664
Punches.....	545-548, 664
Purchase Orders.....	454
Push Pins.....	268
Puzzles.....	657

# R

Racks.....	214
Raffle Boxes.....	285
Raffle Tickets.....	285
Range Extenders.....	84, 91-92
Receipts.....	453
Reception Desks.....	197
Rechargeable NiMH Batteries.....	97, 99
Reclosable Tabs and Strips.....	567-568
Record Books.....	451-452
Recycling Containers.....	376-378, 681
Reduced Effort Staplers.....	538-539
Reduction Scales.....	550
Reference Books.....	662

Reference Material Racks.....	273
-------------------------------	-----

## REFILLS

- Duster Refills.....	366
- Ledger Refill Pages.....	451
- Lint Refills.....	366
- Mop Refills.....	371-373
- Notebooks Refills.....	425-427
- Pen Refills.....	599, 610-611, 668
- Personal Organizers Refills.....	442
- Staplers.....	536-537, 543-544
Refillable Notebooks.....	425-427
Refrigerators.....	292
Reinforcements Strips.....	511
Removable Adhesive Strips.....	569
Removable Hooks and Fasteners.....	569
Repair Order Forms.....	454
Replacement Blades.....	553-555
Replacement Ribbons.....	155
Report Cover Labels.....	479
Report Covers.....	524-529, 677
Requisitions.....	454
Resealable Bags.....	312, 400
Return Shells/Bridges.....	168
Reusable Containers.....	312-313
Reusable Ties.....	77
Reusable Wipers.....	365
Ring Binder Cases.....	220, 676
Roll Towels.....	342-344
Rollerball Pens.....	608-609, 670
Rolling File Boxes.....	496, 680

Rotary Trimmers.....	552-553
Round Ring Binders.....	502, 504, 506, 676
Routers.....	88-89
Rubber Bands.....	574-575
Rubber Fingertips.....	395
Rulers.....	549, 642, 665

# S

Safes.....	217
Safety Glasses / Goggles.....	318
Safety Helmets.....	320
Safety Knives.....	553
Safety Vests.....	320-321
Sales Orders.....	454
Sandwich Sign Boards.....	277
Sanitary Napkins.....	349
Scented Odour Eliminators.....	351
School Scissors.....	558, 642, 665
Scientific Calculators.....	135-136, 667
Scissors.....	329, 557-558, 665
Scrapbooks.....	644, 646
Scrappers.....	367
Screen Cleaners and Kits.....	72
Screen Filters.....	21-22
Screw Drivers.....	367
Scrubbers.....	364

Seat Cushions.....	70	Sketch Books/Pads.....	644-647	Staple Guns.....	543
Secure File Boxes.....	216	Sling Bags.....	223, 229	Staple Removers.....	543, 664
Secure USB Drives.....	43	Slot Punches.....	548	Staplers.....	536-543, 664
Security Pens.....	604	Small Office Shredders.....	115, 117, 118	Staples.....	536-537, 543-544
Self-Adhesive Strips.....	511	Small Size Binders.....	508	Statements.....	453
Self-Adhesive Notes.....	447-449	Small Tab Dividers.....	518	Static Sheets.....	269
Self-Adhesive Pockets.....	511	Smartphone Cases.....	32-34	Steel Bookcases.....	175
Self-Inking Stamps.....	581, 583-584	Smocks.....	635	Steno Pads.....	432, 434
Shelving Racks.....	214	Smoking Receptacles.....	378	Step Sorters.....	245
Sensory Toys.....	682-683	Snacks.....	302-305	Step-On Waste Containers.....	377
Set Squares.....	550, 667	Snippers.....	558	Step Stools.....	367
Shampoo.....	333	Social Games.....	657	Sticker Paper.....	418
Share Certificates.....	455	Sofas.....	198-199	Stirrers.....	309
Sharp Object Containers.....	331	Soft Drinks.....	301	Stools.....	192-193
Shipping Boxes.....	396	Software.....	23, 662	Storage Boxes.....	495-496, 680
Shipping Labels.....	402, 473-474	Sorters.....	240, 242, 245, 678	Storage Cabinets.....	212-213
Shipping Tags.....	401	Speakers.....	15-16	Storage Cubes /Bins.....	237-238, 681
Shirts.....	321	Sponge Mops.....	372	Storage Files/Drawers.....	491, 493-494
Shoe Covers.....	320	Sponges.....	364	Strapping Kits.....	402
Shop Ticket Holders.....	523, 677	Spoons.....	310, 313	Straws.....	309
Shredder Bags.....	120	Sports Bags.....	223	Stretch Wrap.....	402
Shredder Lubricants.....	120	Spray Adhesives.....	566	Stretch Wrap Dispensers.....	402
Shredders.....	115-119	Spray Bottles.....	366	Stretchers.....	331
Sidewalk Chalk.....	640	Spray Mops.....	371-372	Stylus.....	34
Sign Holders.....	248-249, 277, 279	Stamp Holders / Racks.....	585	Stylus Pens.....	605
Sit-to-Stand Desktop Converters.....	64-65	Stamp Ink / Cartridges.....	585	Sugar.....	299
.....	64-65	Stamps.....	579-584	Suggestion Boxes.....	285
Sit-to-Stand Workstations.....	159-160-161	Stand-Up Workstations.....	172	Suitcases.....	228
.....	159-160-161	Standard Notes.....	447-450	Sunscreens.....	332
Sketch Boards.....	533	Standard Toilet Tissue Rolls.....	346-348	Super Glues.....	566, 642

Super Sticky Notes.....	447-449	- Carpet Tapes.....	572	Time Clocks.....	155
Surge Protectors.....	100-101	- Correction Tapes.....	617-618, 670	Time Sheets.....	155
Swabs.....	328	- Double Sided Tapes.....	572	Timecards.....	155
Sweepers.....	368	- Duct Tapes.....	572	Timers.....	255
Sweeping Compounds.....	361	- Embossing Tapes.....	128	TimeTimer Clocks.....	675
Sweetener.....	299	- Filament Tapes.....	572	Toasters.....	293
Switches.....	79-83	- Grid Tapes.....	264	Toilet Bowl Brushes/Mops.....	349, 356

# T

Tab Dividers with Table of Content.....	512-513	- Invisible Office Tapes.....	570	Toilet Bowl Cleaners.....	358
Tabbed Page Protectors.....	523	- Magnetic Tapes.....	264	Toilet Seat Cover Dispensers.....	348
Table Bases.....	169-171	- Masking/Painters Tapes.....	572	Toilet Seat Covers.....	348
Table Dollies.....	202	- Mounting Tapes.....	567-568	Toilet Tissue.....	347-348
Tables.....	168, 202, 684-685	- Packaging Tapes.....	397-398	Toilet Tissue Dispensers.....	348
Tablet Sleeves.....	229	- Tape Measures.....	367	Toiletries Kit.....	228
Tabletop Easels.....	270	- Transparent Office Tapes.....	570	Tongue Depressors.....	331
Tabletops.....	169-171	- Vinyl Tapes.....	572	Tool Kits/Boxes.....	367
Tableware Kits.....	310	Tape Measures.....	367	Toothbrushes.....	333
Tag Wire.....	401	Task Chairs.....	186-188	Toothpaste.....	333
Tally Counter.....	285	Tea.....	296, 298	Totes.....	495-496, 680
Tampons.....	349	Teachers Desks.....	686	Towel Dispensers.....	342, 345
Tank Style Highlighters.....	633, 673	Teaching Tools.....	675	Toy Boxes.....	656
<b>TAPES</b>		Tear-Resistant Envelopes.....	393	Toys.....	682-683
- Art Tapes.....	642-643	Telescoping Tube Cases.....	647	Tracing Paper.....	647
- Barrier Tapes.....	323	Tempera Paint.....	635	Traffic Cones/Signs.....	323
- Book Tapes.....	570	Tent Cards.....	417	Transcribers.....	150
		Thermal Printing Rolls.....	421	Transfer Paper.....	419
		Thermometers.....	330	Transparent Office Tape.....	570
		Thumb Tacks.....	268	Trash Can Liners.....	380-381
		Ticket Dispensers.....	285	Triangles.....	550, 667
		Ticket Punches.....	548	Trimmer Replacement Blades.....	553
		Tickets.....	285	Trimmer Replacement Mats.....	553

Trimmers..... 552, 667  
Tweezers..... 329  
Twine..... 400  
Two-Way Radios..... 31  
Tyvek Envelopes..... 393

## U

Undated Planners..... 442  
Uninterruptable Power Supply (UPS).....  
..... 95  
Unpunched Page Protectors..... 523  
Upholstery Cleaners..... 361  
Urinal Screens/Pucks..... 349  
USB Cables..... 75  
USB Drive Accessories..... 47  
USB Drives..... 43-44  
Utensils..... 310, 313  
Utility Carts..... 404-405  
Utility Knives..... 554-555

## V

Vacuums..... 370  
Vehicle Daily Inspection Report Books  
..... 452

Vehicle Expense Books..... 452  
Vertical File Sorters..... 240, 242, 245  
Vertical Filing Cabinets..... 209-211  
Vinyl Expanding Files..... 485-488, 677  
Vinyl Tape..... 572  
Visitor Log..... 442  
Voice Recorder Headsets..... 150  
Voice Recorders..... 150

## W

Wall Calendars..... 443  
Wall Clocks..... 255  
Wall Planners..... 442  
Wallets..... 228-229  
Waste Bins..... 377-378  
Waste Container Dollies..... 378  
Waste Container Lids..... 377-378  
Waste Containers..... 375-377, 681  
Water Coolers/Dispensers..... 292  
Watercolour Books/Pads..... 646  
Watercolour Crayons / Pencils..... 648  
Watercolour Paints..... 637  
Wax Crayons..... 650-651, 656  
Webcams..... 15, 17, 20  
Weekly Dated Planners..... 440, 441  
Wet Mops..... 373  
Wet-Erase Markers..... 621, 623, 663

Whiteboard Markers..... 620-623, 674  
Whiteboard Surfaces..... 262  
Whiteboards..... 249, 257-263, 267, 674  
Whole Home Wi-Fi..... 90, 92  
Wide Format Paper Rolls..... 420  
Wi-Fi..... 90, 92  
Window Cleaners..... 359  
Wipes..... 328  
Wire..... 401  
Wooden Sticks..... 641  
Workstations..... 167-168  
Wound Dressings..... 328  
Wrap/Splints..... 329, 331  
Wringers..... 366  
Wrist Rests..... 57-58  
Write-On Tab Dividers..... 514

## Y

Yacht Mops..... 373  
Yard Sticks..... 549

## Z

Zipper Padfolios..... 220





**FROM THE MARKER  
FOR EVERYTHING...**

**COMES THE PEN FOR  
EVERYTHING ELSE**



**Sharpie®**

**S-GEL™**



**Every Desk Needs A Sharpie®**



**No Smear, No Bleed Technology**

**Intensely Bold Gel Ink Colours  
Offer Always Vivid Writing**

**Available In A Range Of  
Colours and Designs**

**Ink Colours Offered**



Black, Blue, Red, Purple or  
Green Ink

**Barrel Colours**



Black, Pearl White or  
Frost Blue Plastic Barrel



Gunmetal Gray or  
Champagne Metal Barrel

**Tips**

**0.5mm**  
Fine Point



**0.7mm**  
Medium Point



**1.0mm**  
Bold Point





**super sticky**  
notes

# Post-it® Super Sticky Recycled Notes

Made with 100% recycled paper in  
100% recycled paperboard packaging.

\*Made with a water-based adhesive.

